

Description: 5G-FR1/WiFi/GNSS Low Profile Vehicular Multiband Antenna**PART NUMBER: ARM5GXXXXDM****Features:**

- 2x 617-960/1710-6000MHz
 - 4G (LTE) / 5G-FR1
 - Includes Band 71 (617-698 MHz)
- 2x 2400-2500/5150-5925MHz WiFi
- 1x GNSS Active:
 - Beidou, GPS, Glonass
 - RHCP polarization
 - Amplifier Gain 30dBi
- Omni radiation pattern
- Size: L x W x H 202.3 x 88.5 x 45mm
- IP67

Applications:

- 2G/3G/4G/5G radios
- CBRS Band 42 and 48 (3.4-3.7GHz)
- Vehicular use
- Utility boxes
- Smart metering
- IoT Devices

Issue: 2111

In the effort to improve our products, we reserve the right to make changes judged to be necessary.

CONFIDENTIAL AND PROPRIETARY INFORMATION

This document contains confidential and proprietary information of Pulse Electronics, Inc. (Pulse) and is protected by copyright, trade secret and other state and federal laws. Its receipt or possession does not convey any rights to reproduce, disclose its contents, or to manufacture, use or sell anything it may describe. Reproduction, disclosure or use without specific written authorization of Pulse is strictly forbidden.

For more information:

Pulse Worldwide Headquarters
15255 Innovation Drive #100
San Diego, CA 92128
USA
Tel: 1-858-674-8100

Pulse/Larsen Antennas
18110 SE 34th St Bldg 2 Suite 250
Vancouver, WA 98683
USA
Tel: 1-360-944-7551

Europe Headquarters
Pulse GmbH & Do, KG
Zeppelinstrasse 15
Herrenberg, Germany
Tel: 49 7032 7806 0

Pulse (Suzhou) Wireless Products Co, Inc.
99 Huo Ju Road(#29 Bldg,4th Phase
Suzhou New District
Jiangsu Province, Suzhou 215009 PR China
Tel: 86 512 6807 9998

Series: ARMADILLO

Description: 5G-FR1/WiFi/GNSS Low Profile Vehicular Multiband Antenna

PART NUMBER: ARM5GXXXXDM

This document covers all product variants of the following product family

Product	Total Cable Leads	LTE Cable Leads	WiFi Cable Leads	GPS Cable Leads	Housing Color	Cable Length	Mounting
ARM5G62311DM	6	2 (with SMA Male)	3 (with RP-SMA Male)	1 (with SMA Male)	Black	17 FT or 5181mm	1. Direct Mount; 7/8" Hole Required 2. Mounting Surface thickness < 0.25"
ARM5G62312DM	6	2 (with SMA Male)	3 (with RP-SMA Male)	1 (with SMA Male)	White		
ARM5G52211DM	5	2 (with SMA Male)	2 (with RP-SMA Male)	1 (with SMA Male)	Black		
ARM5G52212DM	5	2 (with SMA Male)	2 (with RP-SMA Male)	1 (with SMA Male)	White		
ARM5G42111DM	4	2 (with SMA Male)	1 (with RP-SMA Male)	1 (with SMA Male)	Black		
ARM5G42112DM	4	2 (with SMA Male)	1 (with RP-SMA Male)	1 (with SMA Male)	White		
ARM5G32011DM	3	2 (with SMA Male)	0	1 (with SMA Male)	Black		
ARM5G32012DM	3	2 (with SMA Male)	0	1 (with SMA Male)	White		

Issue: 2111

In the effort to improve our products, we reserve the right to make changes judged to be necessary.

CONFIDENTIAL AND PROPRIETARY INFORMATION

This document contains confidential and proprietary information of Pulse Electronics, Inc. (Pulse) and is protected by copyright, trade secret and other state and federal laws. Its receipt or possession does not convey any rights to reproduce, disclose its contents, or to manufacture, use or sell anything it may describe. Reproduction, disclosure or use without specific written authorization of Pulse is strictly forbidden.

For more information:

Pulse Worldwide Headquarters
15255 Innovation Drive #100
San Diego, CA 92128
USA
Tel: 1-858-674-8100

Pulse/Larsen Antennas
18110 SE 34th St Bldg 2 Suite 250
Vancouver, WA 98683
USA
Tel: 1-360-944-7551

Europe Headquarters
Pulse GmbH & Do, KG
Zeppelinstrasse 15
Herrenberg, Germany
Tel: 49 7032 7806 0

Pulse (Suzhou) Wireless Products Co, Inc.
99 Huo Ju Road(#29 Bldg,4th Phase
Suzhou New District
Jiangsu Province, Suzhou 215009 PR China
Tel: 86 512 6807 9998



Series: ARMADILLO

Description: 5G-FR1/WiFi/GNSS Low Profile Vehicular Multiband Antenna

PART NUMBER: ARM5GXXXXDM

This document covers all product variants of the following product family

Product Numbering

Vehicular Multiband Antenna with Direct Mount



1	Product ID: ARMADILLO
2	Total Number of Cable leads
3	Total Number of LTE Cable Leads
4	Total Number of WiFi Cable Leads
5	Total Number of GPS Cable Leads
6	The Color of the Plastic Housing 1=Black; 2= White
7	Mounting: Direct Mount; 7/8" Hole Required

Issue: 2111

In the effort to improve our products, we reserve the right to make changes judged to be necessary.

CONFIDENTIAL AND PROPRIETARY INFORMATION

This document contains confidential and proprietary information of Pulse Electronics, Inc. (Pulse) and is protected by copyright, trade secret and other state and federal laws. Its receipt or possession does not convey any rights to reproduce, disclose its contents, or to manufacture, use or sell anything it may describe. Reproduction, disclosure or use without specific written authorization of Pulse is strictly forbidden.

For more information:

Pulse Worldwide Headquarters
15255 Innovation Drive #100
San Diego, CA 92128
USA
Tel: 1-858-674-8100

Pulse/Larsen Antennas
18110 SE 34th St Bldg 2 Suite 250
Vancouver, WA 98683
USA
Tel: 1-360-944-7551

Europe Headquarters
Pulse GmbH & Do, KG
Zeppelinstrasse 15
Herrenberg, Germany
Tel: 49 7032 7806 0

Pulse (Suzhou) Wireless Products Co, Inc.
99 Huo Ju Road(#29 Bldg,4th Phase
Suzhou New District
Jiangsu Province, Suzhou 215009 PR China
Tel: 86 512 6807 9998



Description: 5G-FR1/WiFi/GNSS Low Profile
Vehicular Multiband Antenna**Series:** ARMADILLO**PART NUMBER:** ARM5GXXXXDM**ELECTRICAL SPECIFICATIONS**

Frequency 5G-FR1/LTE	617-960MHz, 1710-6000MHz
Frequency WiFi	2400-2500MHz, 5150-5925MHz
Nominal Impedance	50 Ω
VSWR*	
617-960MHz	<2.5
1710-6000MHz	<2.2
2400-2500MHz	<2
5150-5925MHz	<2
Isolation*	
617-960MHz, 1710-6000MHz	-8dB
2400-2500MHz, 5150-5925MHz	-10dB
Average Peak Gain**	
617-960MHz;	2.2dBi
1710-6000MHz	4.6dBi
2400-2500MHz	5.4dBi
5150-5925MHz	6.3dBi
Polarization	Vertical

*Test on 500mm ground plane with 17ft(5.2m) LMR195 cable

**Test on 500mm ground plane with 1ft(304.8mm) LMR195 cable

Issue: 2111

In the effort to improve our products, we reserve the right to make changes judged to be necessary.

CONFIDENTIAL AND PROPRIETARY INFORMATION

This document contains confidential and proprietary information of Pulse Electronics, Inc. (Pulse) and is protected by copyright, trade secret and other state and federal laws. Its receipt or possession does not convey any rights to reproduce, disclose its contents, or to manufacture, use or sell anything it may describe. Reproduction, disclosure or use without specific written authorization of Pulse is strictly forbidden.

Description: 5G-FR1/WiFi/GNSS Low Profile
Vehicular Multiband Antenna

Series: ARMADILLO

PART NUMBER: ARM5GXXXXDM

ELECTRICAL SPECIFICATIONS

GPS Antenna	
Frequency	1561.098±2.046MHz/ 1575.42±1.023MHz/ 1602.5625±4MHz
Nominal Impedance	50 Ω
VSWR	<2
Gain (Radiating Element)	-1 dBic±1 dB
Gain (LNA Gain)	30 dB± 2 dB
Polarization	RHCP
Out of Band Rejection	
617 MHz	>70 dB
960 MHz	>65 dB
1710 MHz	>60 dB
6000 MHz	>60 dB
2400 MHz	>65 dB
2700 MHz	>65 dB
Noise Figure	<2.4 dB
Operating Voltage	3.3 – 5 Vdc
Current Consumption	<15mA
RF-chain line-up	Ant-Filter1-LNA1-Filter2-LNA2

Description: 5G-FR1/WiFi/GNSS Low Profile
Vehicular Multiband Antenna

Series: ARMADILLO

PART NUMBER: ARM5GXXXXDM

MECHANICAL SPECIFICATIONS

Overall Length	202.3mm X 88.5mm X 45mm
Weight	1.15 kg
Antenna Color / Material	Black or White
Connector type	Refer to Page 2
Cable type	Refer to Page 2
Cable length	Refer to Page 2

ENVIRONMENTAL SPECIFICATIONS

Operating Temperature	-40 ~ +85° C
Storage Temperature	-40 ~ +85° C
Ingress Protection	IP67
RoHS Compliant	Yes

OTHER SPECIFICATIONS

Total cable assembly loss for 5.2m (17') LMR-195 @850MHz	2.1dB
Total cable assembly loss for 5.2m (17') LMR-100 @1575MHz	5.9dB
Total cable assembly loss for 5.2m (17') LMR-195 @1930MHz	3.2dB
Total cable assembly loss for 5.2m (17') LMR-195 @2450MHz	3.6dB
Total cable assembly loss for 5.2m (17') LMR-195 @2500MHz	3.7dB
Total cable assembly loss for 5.2m (17') LMR-195 @5350MHz	5.5dB

Description: 5G-FR1/WiFi/GNSS Low Profile Vehicular Multiband Antenna

Series: ARMADILLO

PART NUMBER: ARM5GXXXXDM

MECHANICAL DRAWING

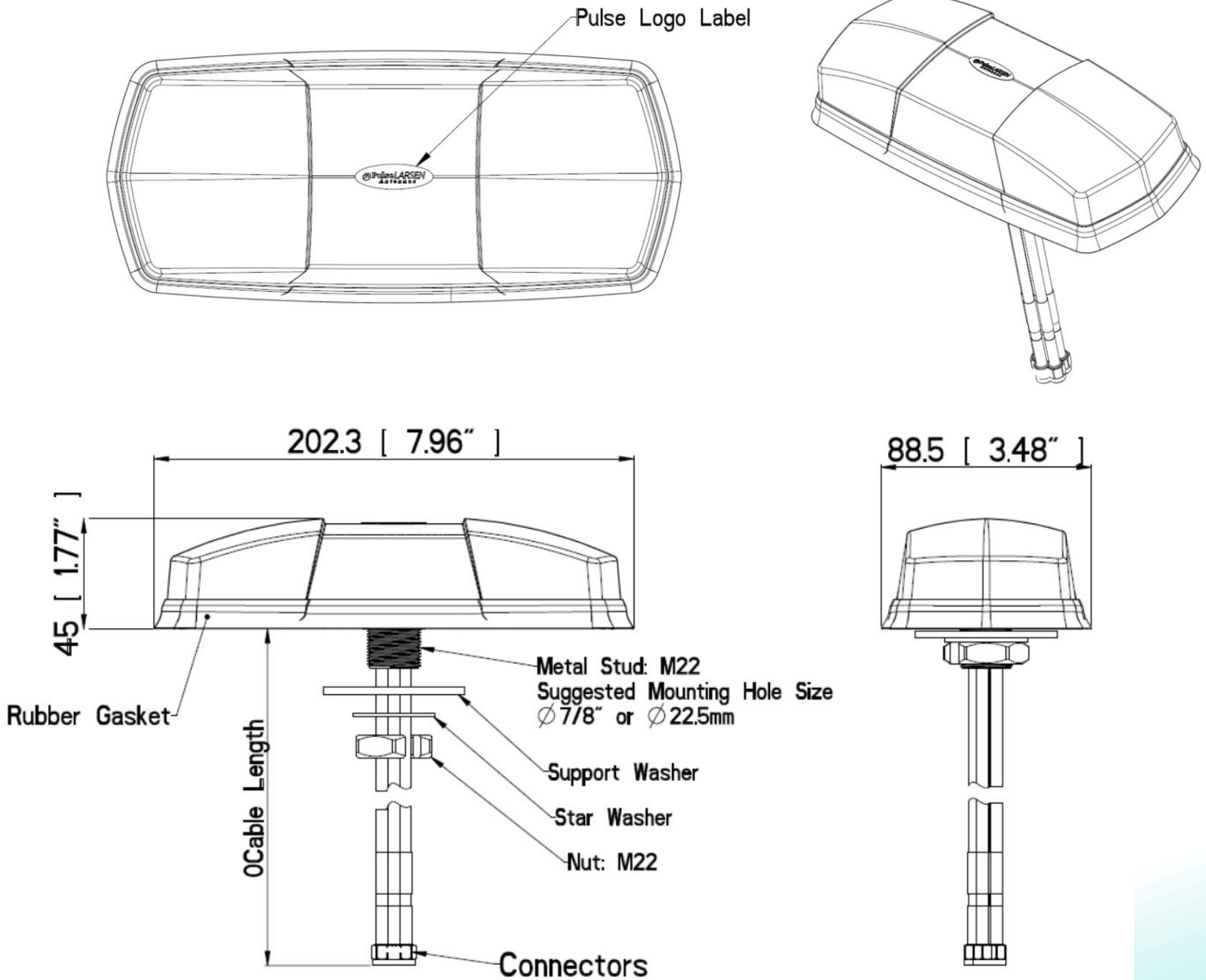

Issue: 2111

In the effort to improve our products, we reserve the right to make changes judged to be necessary.

CONFIDENTIAL AND PROPRIETARY INFORMATION

This document contains confidential and proprietary information of Pulse Electronics, Inc. (Pulse) and is protected by copyright, trade secret and other state and federal laws. Its receipt or possession does not convey any rights to reproduce, disclose its contents, or to manufacture, use or sell anything it may describe. Reproduction, disclosure or use without specific written authorization of Pulse is strictly forbidden.

MECHANICAL DRAWING

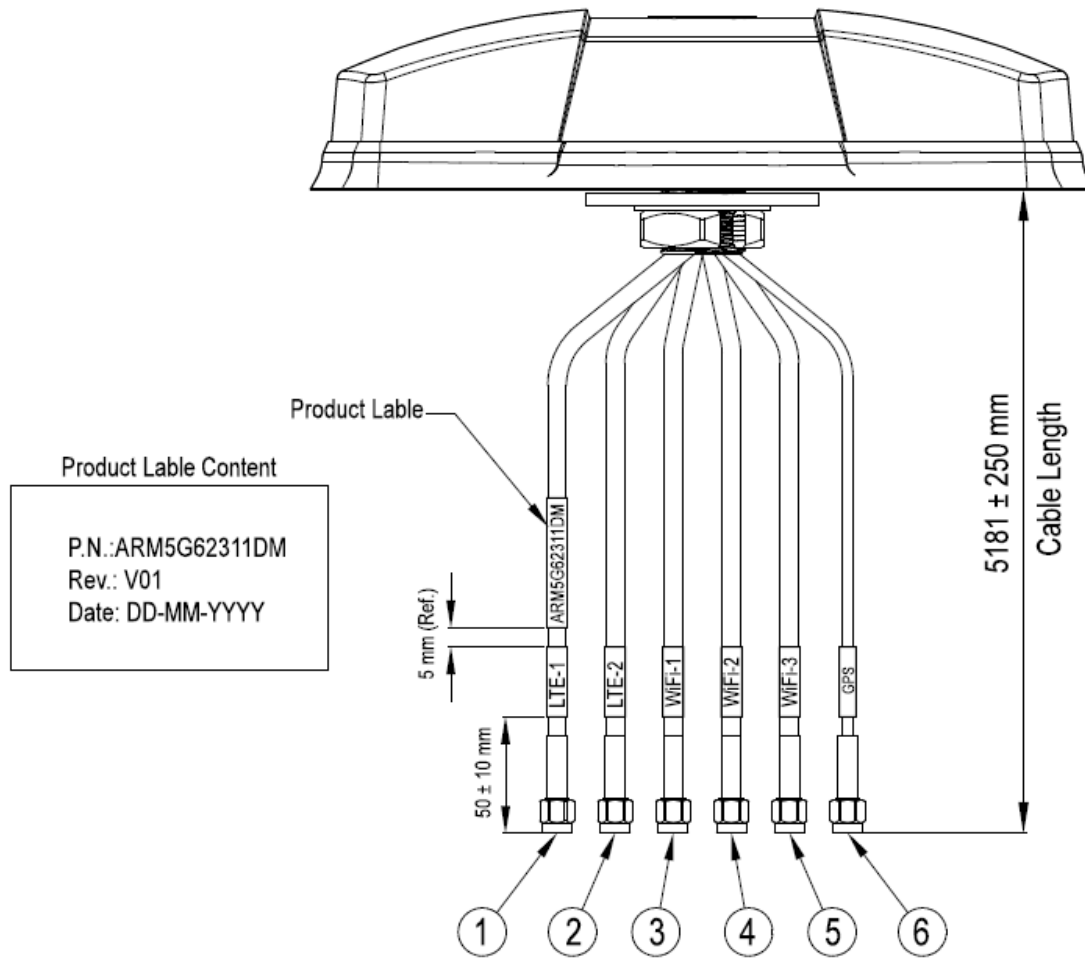

	ARM5G62311DM	CABLE	CABLE LENGTH	CONNECTOR
1	LTE-1 Cable Assy	LMR-195 *	5181 mm / 204" / 17 FT	SMA Male
2	LTE-2 Cable Assy			
3	WiFi-1 Cable Assy	LMR-195*		RP-SMA Male
4	WiFi-2 Cable Assy			
5	WiFi-3 Cable Assy			
6	GPS Cable Assy	LMR-100*		SMA Male

* or equivalent

Description: 5G-FR1/WiFi/GNSS Low Profile
Vehicular Multiband Antenna

Series: ARMADILLO

PART NUMBER: ARM5GXXXXDM

TEST SETUP

Antenna tested on a $\varnothing 500\text{mm}$ ground plane.

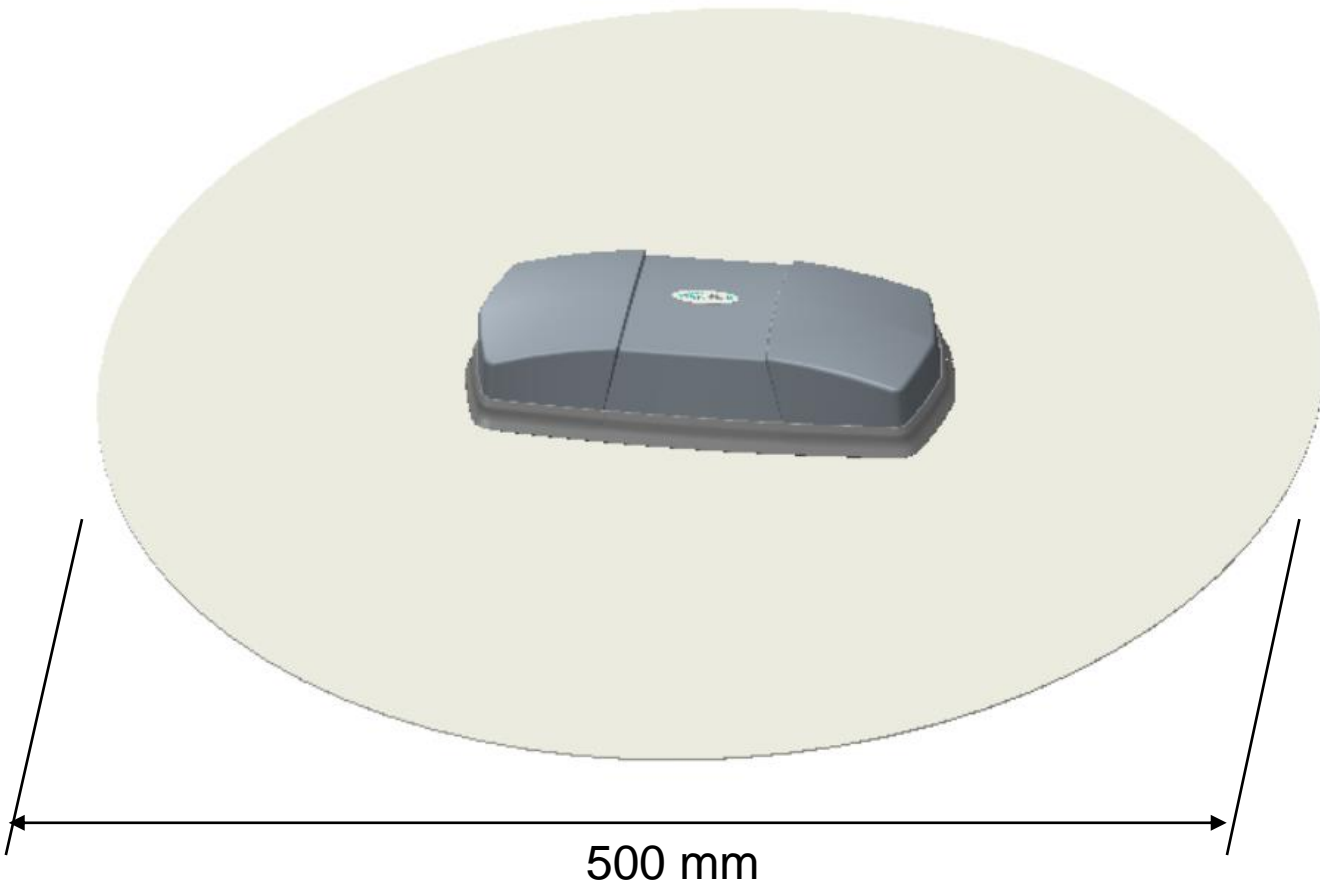

Issue: 2111

In the effort to improve our products, we reserve the right to make changes judged to be necessary.

CONFIDENTIAL AND PROPRIETARY INFORMATION

This document contains confidential and proprietary information of Pulse Electronics, Inc. (Pulse) and is protected by copyright, trade secret and other state and federal laws. Its receipt or possession does not convey any rights to reproduce, disclose its contents, or to manufacture, use or sell anything it may describe. Reproduction, disclosure or use without specific written authorization of Pulse is strictly forbidden.

Series: ARMADILLO

Description: 5G-FR1/WiFi/GNSS Low Profile Vehicular Multiband Antenna

PART NUMBER: ARM5GXXXXDM

CHARTS

VSWR (LTE)

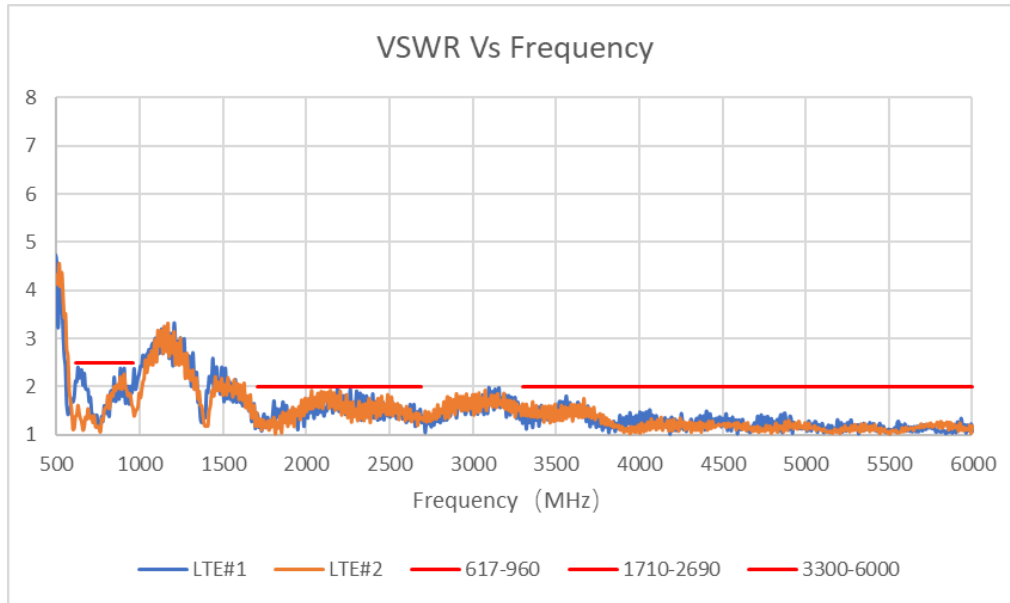

Isolation (LTE)

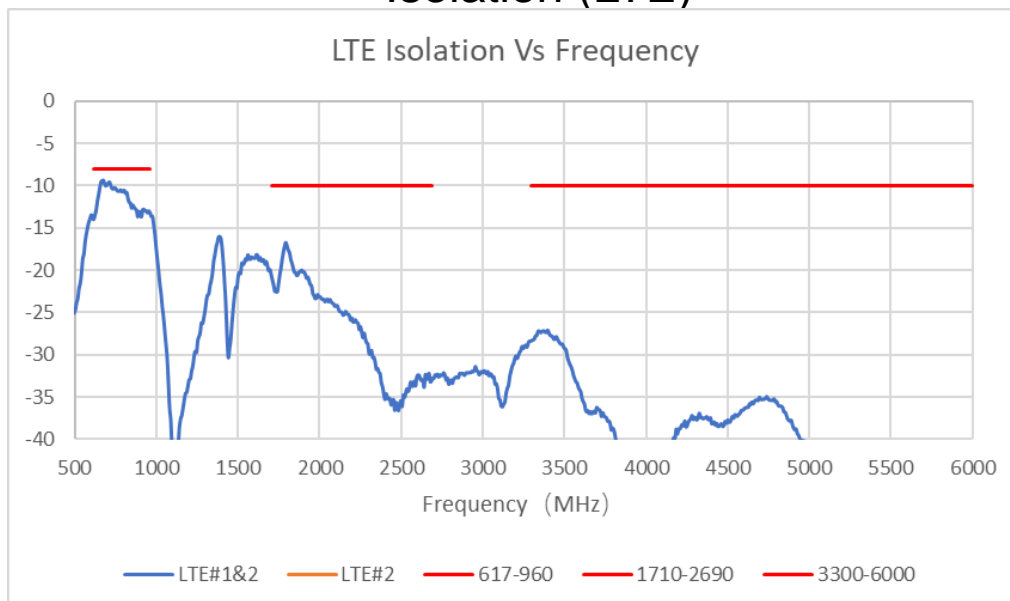

Note : Antenna tested with 5m cable on 500mm (dia) ground plane

Issue: 2111

In the effort to improve our products, we reserve the right to make changes judged to be necessary.

CONFIDENTIAL AND PROPRIETARY INFORMATION

This document contains confidential and proprietary information of Pulse Electronics, Inc. (Pulse) and is protected by copyright, trade secret and other state and federal laws. Its receipt or possession does not convey any rights to reproduce, disclose its contents, or to manufacture, use or sell anything it may describe. Reproduction, disclosure or use without specific written authorization of Pulse is strictly forbidden.

CHARTS

Radiation Efficiency (LTE)

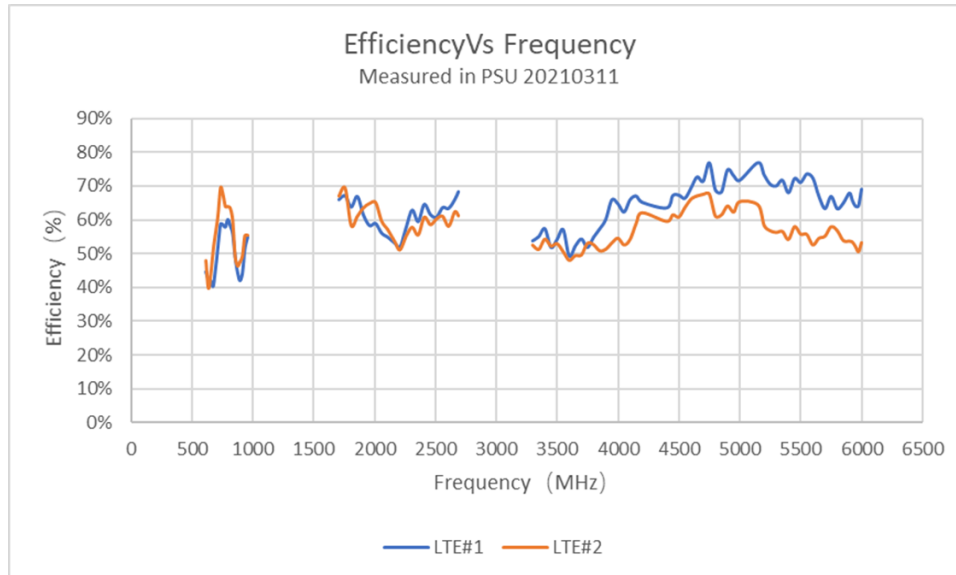

Peak Gain (LTE)

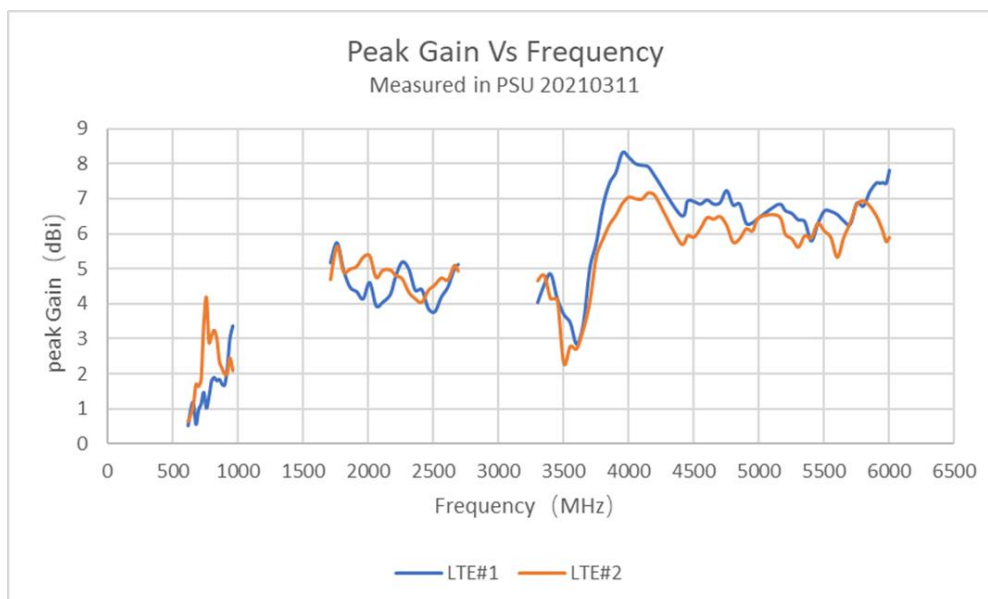

Note : Antenna tested with 1ft(304.8mm) cable on 500mm (dia) ground plane

Issue: 2111

In the effort to improve our products, we reserve the right to make changes judged to be necessary.

CONFIDENTIAL AND PROPRIETARY INFORMATION

This document contains confidential and proprietary information of Pulse Electronics, Inc. (Pulse) and is protected by copyright, trade secret and other state and federal laws. Its receipt or possession does not convey any rights to reproduce, disclose its contents, or to manufacture, use or sell anything it may describe. Reproduction, disclosure or use without specific written authorization of Pulse is strictly forbidden.

Series: ARMADILLO

Description: 5G-FR1/WiFi/GNSS Low Profile Vehicular Multiband Antenna

PART NUMBER: ARM5GXXXXDM

CHARTS

VSWR (WIFI)

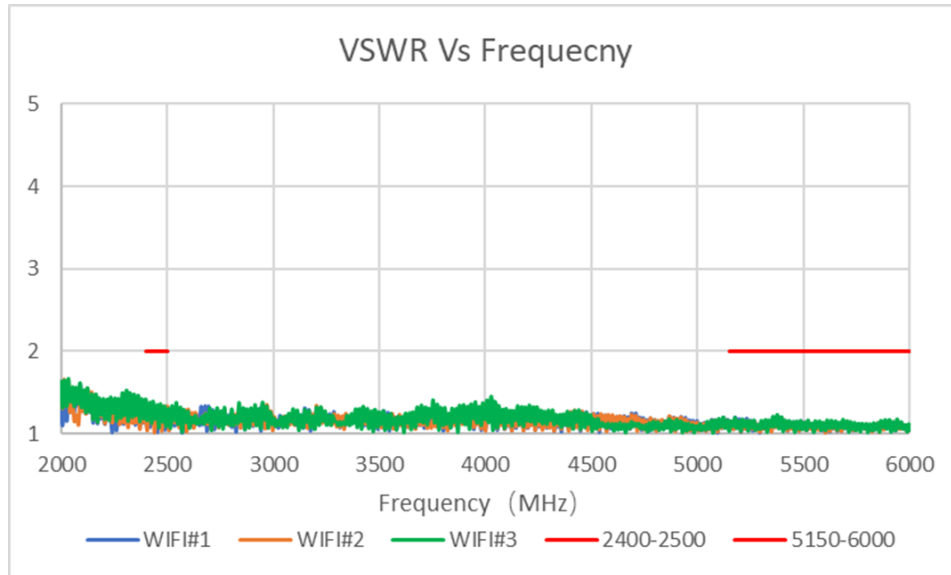

Isolation (WIFI)

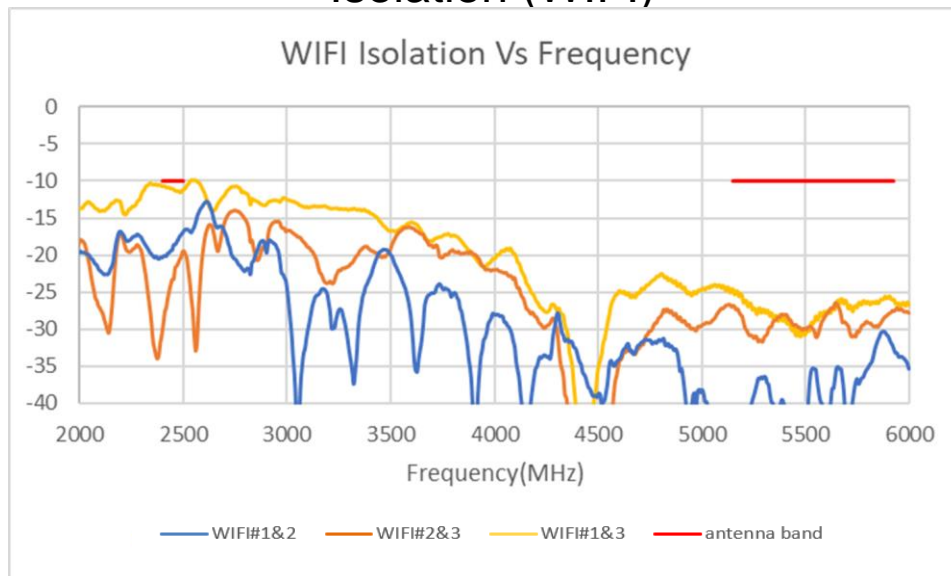

Note : Antenna tested with 5m cable on 500mm (dia) ground plane

Issue: 2111

In the effort to improve our products, we reserve the right to make changes judged to be necessary.

CONFIDENTIAL AND PROPRIETARY INFORMATION

This document contains confidential and proprietary information of Pulse Electronics, Inc. (Pulse) and is protected by copyright, trade secret and other state and federal laws. Its receipt or possession does not convey any rights to reproduce, disclose its contents, or to manufacture, use or sell anything it may describe. Reproduction, disclosure or use without specific written authorization of Pulse is strictly forbidden.

Description: 5G-FR1/WiFi/GNSS Low Profile Vehicular Multiband Antenna

Series: ARMADILLO

PART NUMBER: ARM5GXXXXDM

CHARTS

Radiation Efficiency (WIFI)

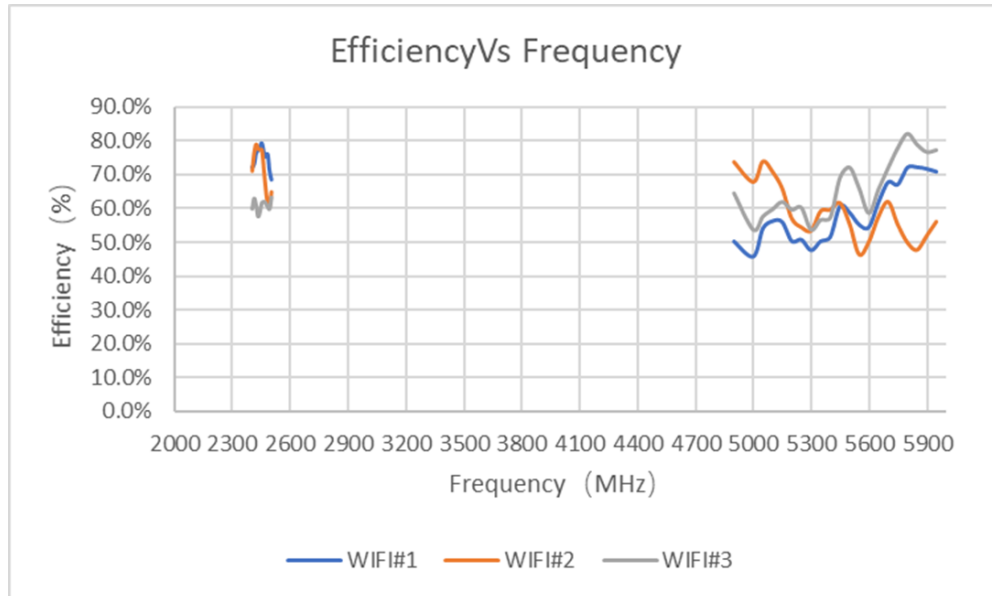

Peak Gain (WIFI)

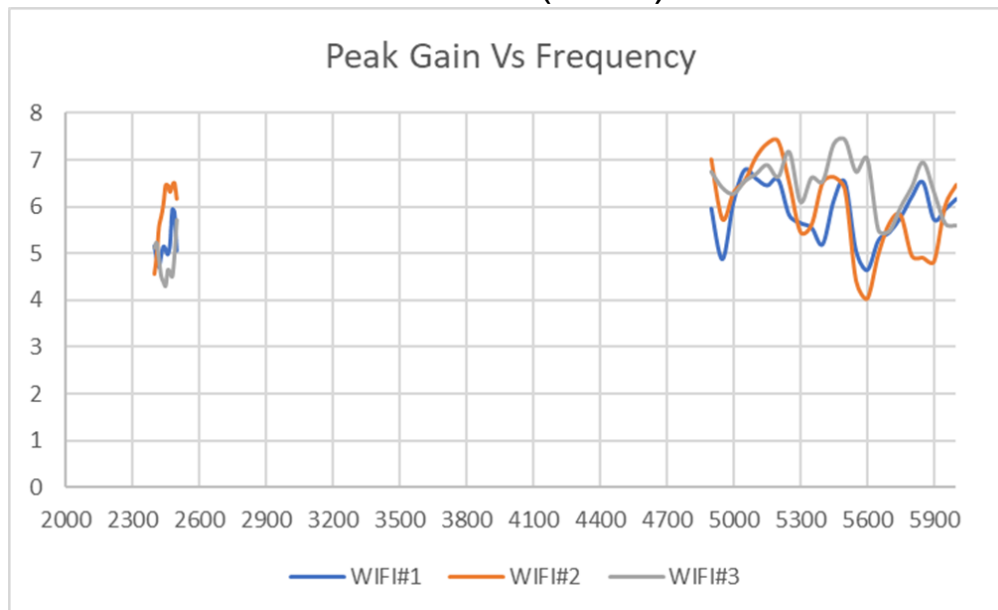

Note : Antenna tested with 1ft(304.8mm) cable on 500mm (dia) ground plane

Issue: 2111

In the effort to improve our products, we reserve the right to make changes judged to be necessary.

CONFIDENTIAL AND PROPRIETARY INFORMATION

This document contains confidential and proprietary information of Pulse Electronics, Inc. (Pulse) and is protected by copyright, trade secret and other state and federal laws. Its receipt or possession does not convey any rights to reproduce, disclose its contents, or to manufacture, use or sell anything it may describe. Reproduction, disclosure or use without specific written authorization of Pulse is strictly forbidden.

Description: 5G-FR1/WiFi/GNSS Low Profile Vehicular Multiband Antenna

Series: ARMADILLO

PART NUMBER: ARM5GXXXXDM

CHARTS

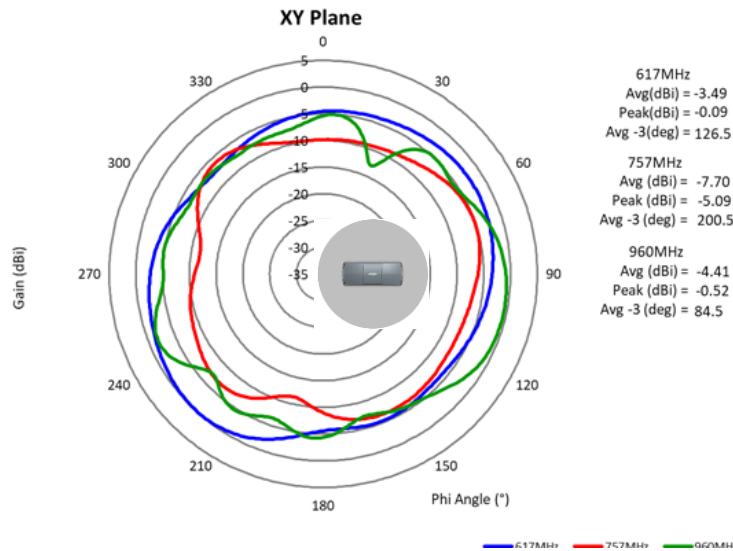

LTE1 XY plane radiation pattern

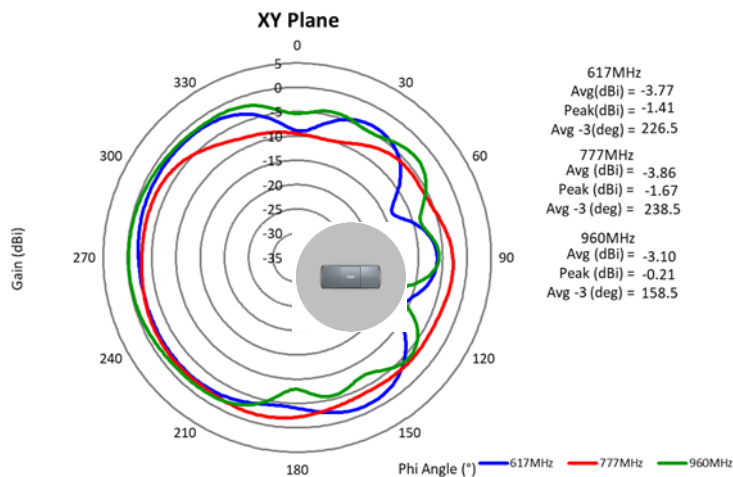

LTE2 XY plane radiation pattern

Issue: 2111

In the effort to improve our products, we reserve the right to make changes judged to be necessary.

CONFIDENTIAL AND PROPRIETARY INFORMATION

This document contains confidential and proprietary information of Pulse Electronics, Inc. (Pulse) and is protected by copyright, trade secret and other state and federal laws. Its receipt or possession does not convey any rights to reproduce, disclose its contents, or to manufacture, use or sell anything it may describe. Reproduction, disclosure or use without specific written authorization of Pulse is strictly forbidden.

Description: 5G-FR1/WiFi/GNSS Low Profile Vehicular Multiband Antenna

Series: ARMADILLO

PART NUMBER: ARM5GXXXXDM

CHARTS

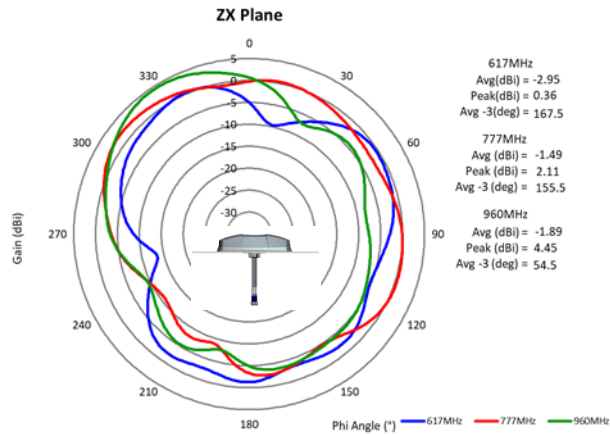

LTE1 ZX plane radiation pattern

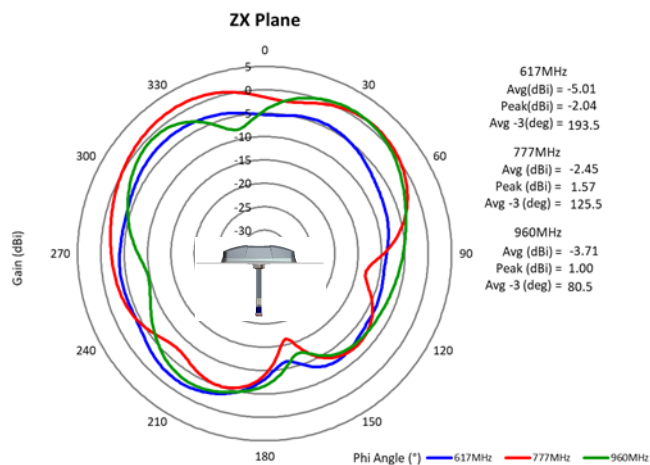

LTE2 ZX plane radiation pattern

Issue: 2111

In the effort to improve our products, we reserve the right to make changes judged to be necessary.

CONFIDENTIAL AND PROPRIETARY INFORMATION

This document contains confidential and proprietary information of Pulse Electronics, Inc. (Pulse) and is protected by copyright, trade secret and other state and federal laws. Its receipt or possession does not convey any rights to reproduce, disclose its contents, or to manufacture, use or sell anything it may describe. Reproduction, disclosure or use without specific written authorization of Pulse is strictly forbidden.

Description: 5G-FR1/WiFi/GNSS Low Profile Vehicular Multiband Antenna

Series: ARMADILLO

PART NUMBER: ARM5GXXXXDM

CHARTS

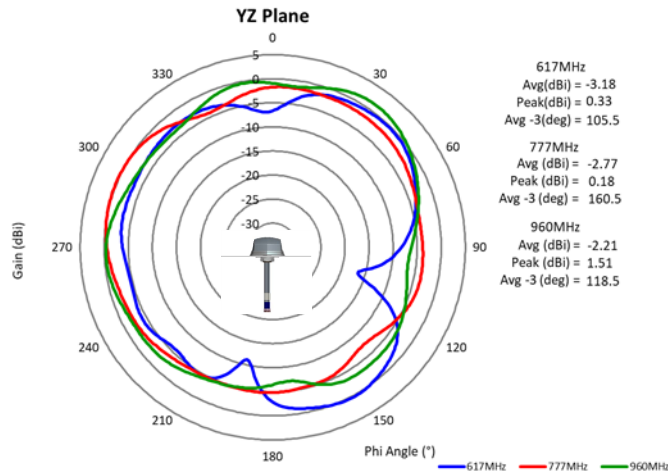

LTE1 YZ plane radiation pattern

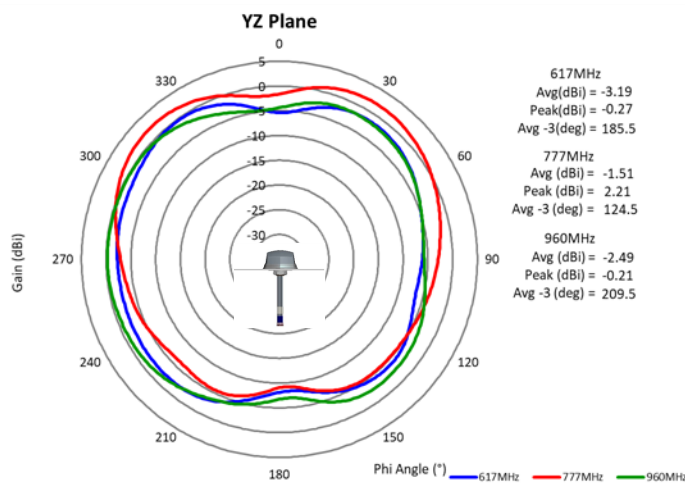

LTE2 YZ plane radiation pattern

Issue: 2111

In the effort to improve our products, we reserve the right to make changes judged to be necessary.

CONFIDENTIAL AND PROPRIETARY INFORMATION

This document contains confidential and proprietary information of Pulse Electronics, Inc. (Pulse) and is protected by copyright, trade secret and other state and federal laws. Its receipt or possession does not convey any rights to reproduce, disclose its contents, or to manufacture, use or sell anything it may describe. Reproduction, disclosure or use without specific written authorization of Pulse is strictly forbidden.

Description: 5G-FR1/WiFi/GNSS Low Profile Vehicular Multiband Antenna

Series: ARMADILLO

PART NUMBER: ARM5GXXXXDM

CHARTS

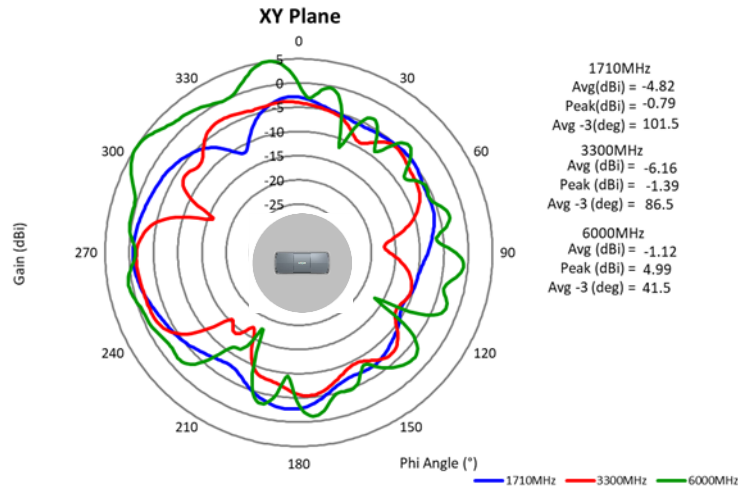

LTE1 XY plane radiation pattern

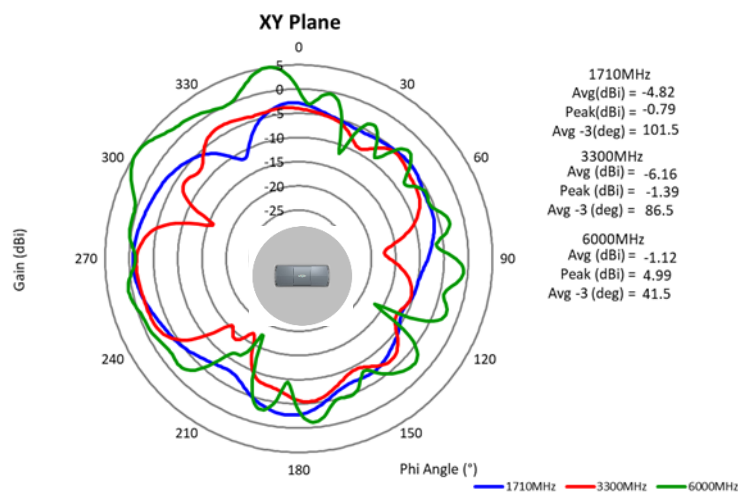

LTE2 XY plane radiation pattern

Issue: 2111

In the effort to improve our products, we reserve the right to make changes judged to be necessary.

CONFIDENTIAL AND PROPRIETARY INFORMATION

This document contains confidential and proprietary information of Pulse Electronics, Inc. (Pulse) and is protected by copyright, trade secret and other state and federal laws. Its receipt or possession does not convey any rights to reproduce, disclose its contents, or to manufacture, use or sell anything it may describe. Reproduction, disclosure or use without specific written authorization of Pulse is strictly forbidden.

Series: ARMADILLO

Description: 5G-FR1/WiFi/GNSS Low Profile Vehicular Multiband Antenna

PART NUMBER: ARM5GXXXXDM

CHARTS

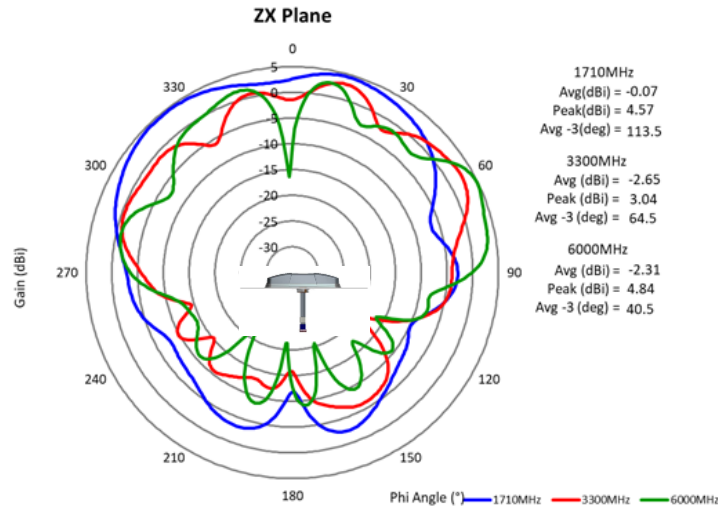

LTE1 ZX plane radiation pattern

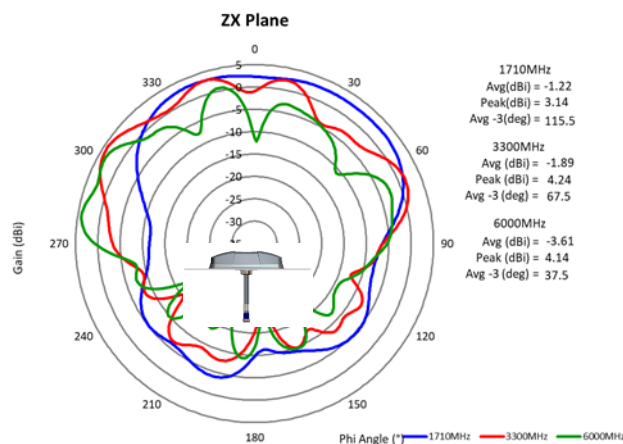

LTE2 ZX plane radiation pattern

Issue: 2111

In the effort to improve our products, we reserve the right to make changes judged to be necessary.

CONFIDENTIAL AND PROPRIETARY INFORMATION

This document contains confidential and proprietary information of Pulse Electronics, Inc. (Pulse) and is protected by copyright, trade secret and other state and federal laws. Its receipt or possession does not convey any rights to reproduce, disclose its contents, or to manufacture, use or sell anything it may describe. Reproduction, disclosure or use without specific written authorization of Pulse is strictly forbidden.

CHARTS

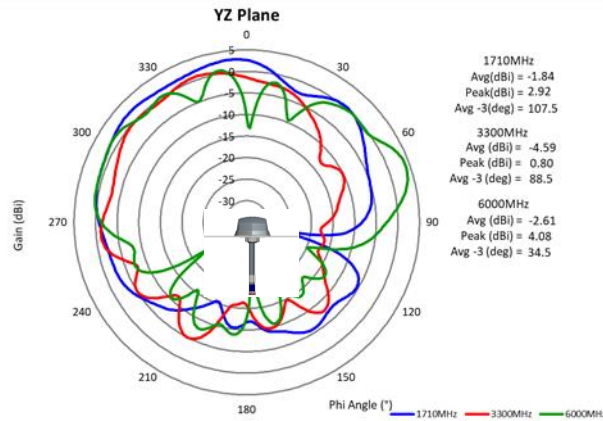

LTE1 YZ plane radiation pattern

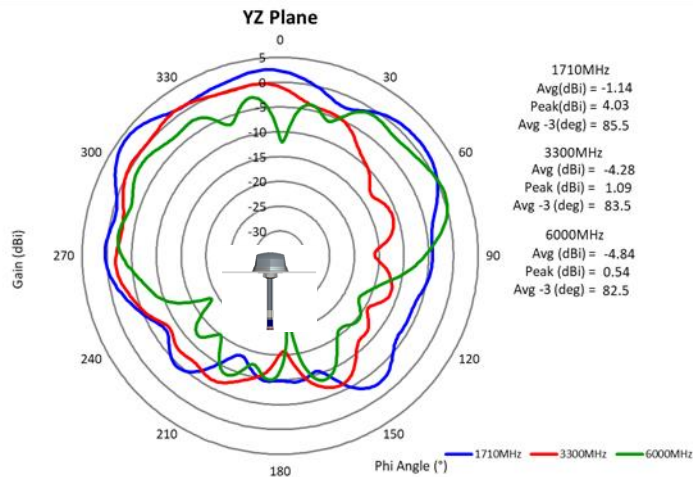

LTE2 YZ plane radiation pattern

Issue: 2111

In the effort to improve our products, we reserve the right to make changes judged to be necessary.

CONFIDENTIAL AND PROPRIETARY INFORMATION

This document contains confidential and proprietary information of Pulse Electronics, Inc. (Pulse) and is protected by copyright, trade secret and other state and federal laws. Its receipt or possession does not convey any rights to reproduce, disclose its contents, or to manufacture, use or sell anything it may describe. Reproduction, disclosure or use without specific written authorization of Pulse is strictly forbidden.

Description: 5G-FR1/WiFi/GNSS Low Profile Vehicular Multiband Antenna

Series: ARMADILLO

PART NUMBER: ARM5GXXXXDM

CHARTS

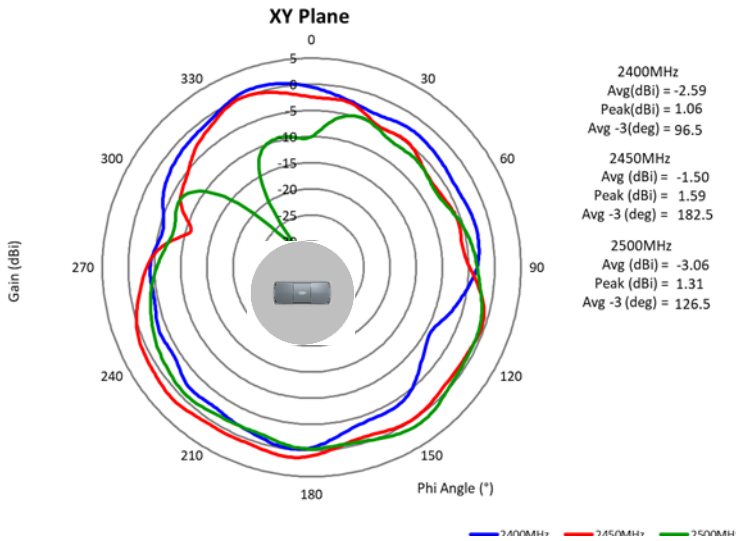

WiFi1 XY plane radiation pattern

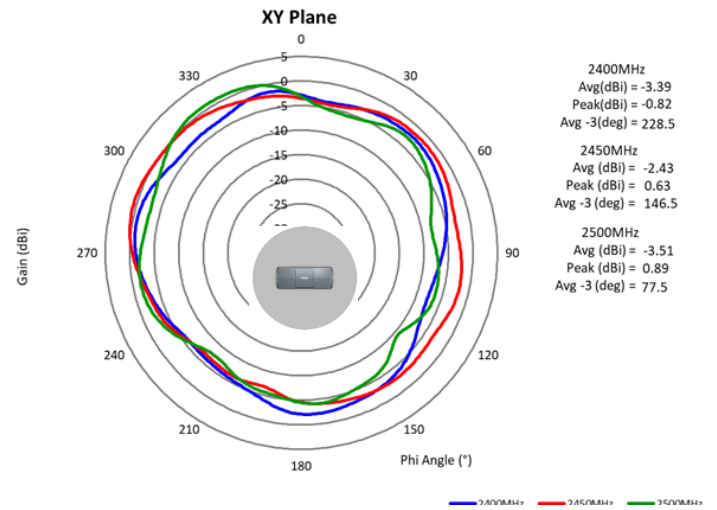

WiFi2 XY plane radiation pattern

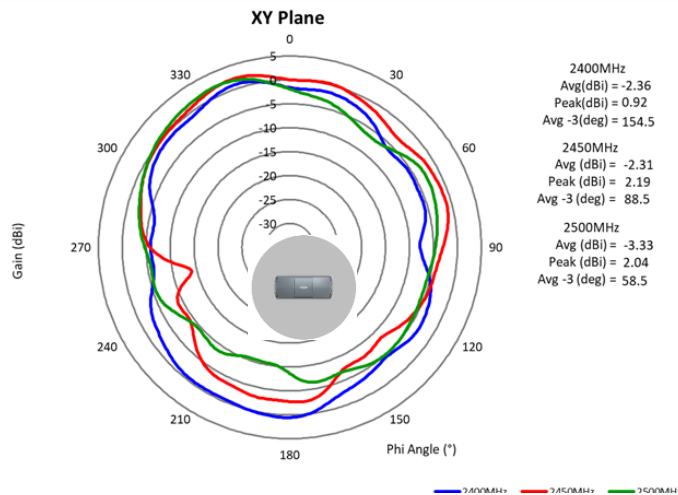

WiFi3 XY plane radiation pattern

Issue: 2111

In the effort to improve our products, we reserve the right to make changes judged to be necessary.

CONFIDENTIAL AND PROPRIETARY INFORMATION

This document contains confidential and proprietary information of Pulse Electronics, Inc. (Pulse) and is protected by copyright, trade secret and other state and federal laws. Its receipt or possession does not convey any rights to reproduce, disclose its contents, or to manufacture, use or sell anything it may describe. Reproduction, disclosure or use without specific written authorization of Pulse is strictly forbidden.

Description: 5G-FR1/WiFi/GNSS Low Profile Vehicular Multiband Antenna

Series: ARMADILLO

PART NUMBER: ARM5GXXXXDM

CHARTS

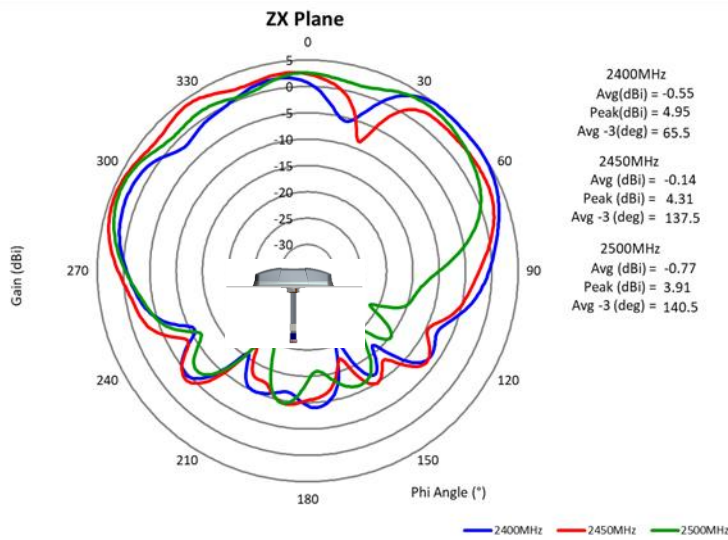

WiFi1 ZX plane radiation pattern

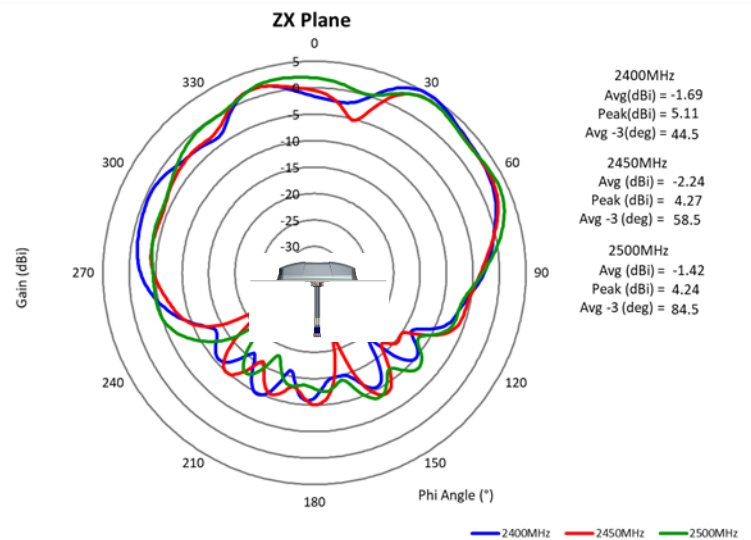

WiFi2 ZX plane radiation pattern

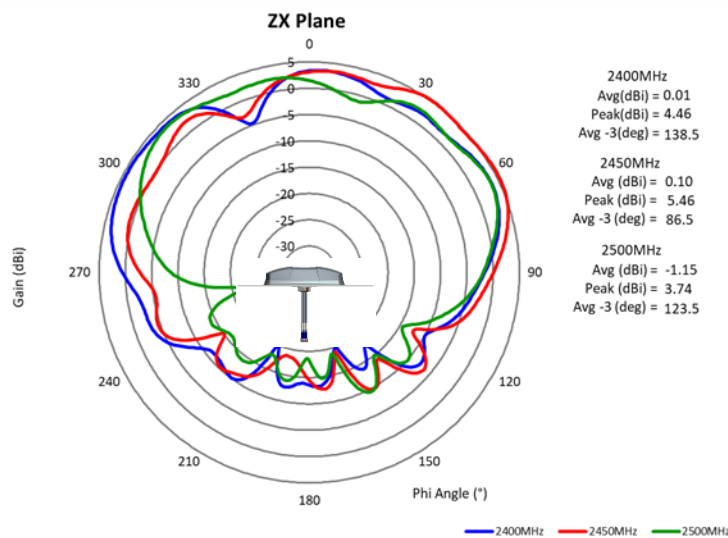

WiFi3 ZX plane radiation pattern

Issue: 2111

In the effort to improve our products, we reserve the right to make changes judged to be necessary.

CONFIDENTIAL AND PROPRIETARY INFORMATION

This document contains confidential and proprietary information of Pulse Electronics, Inc. (Pulse) and is protected by copyright, trade secret and other state and federal laws. Its receipt or possession does not convey any rights to reproduce, disclose its contents, or to manufacture, use or sell anything it may describe. Reproduction, disclosure or use without specific written authorization of Pulse is strictly forbidden.

Description: 5G-FR1/WiFi/GNSS Low Profile Vehicular Multiband Antenna

Series: ARMADILLO

PART NUMBER: ARM5GXXXXDM

CHARTS

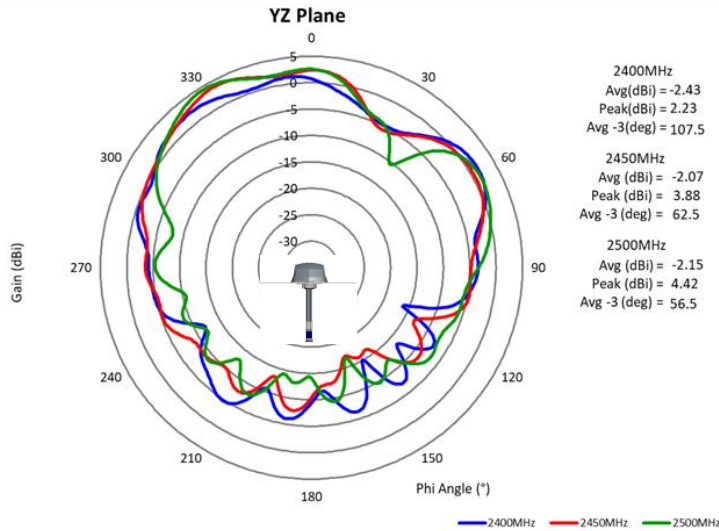

WiFi1 YZ plane radiation pattern

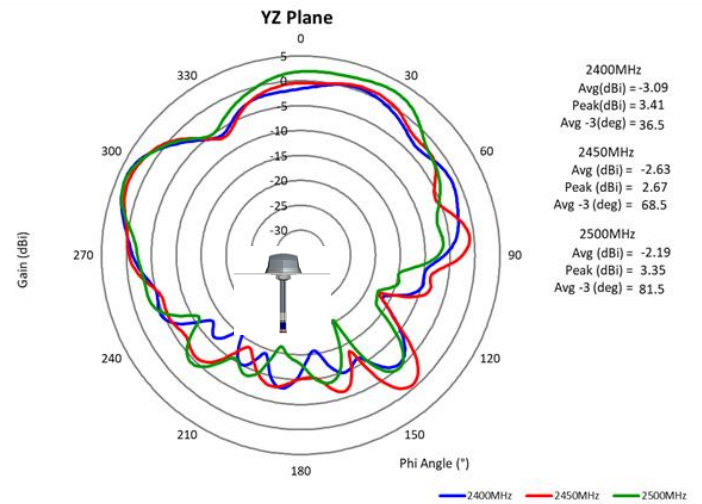

WiFi2 YZ plane radiation pattern

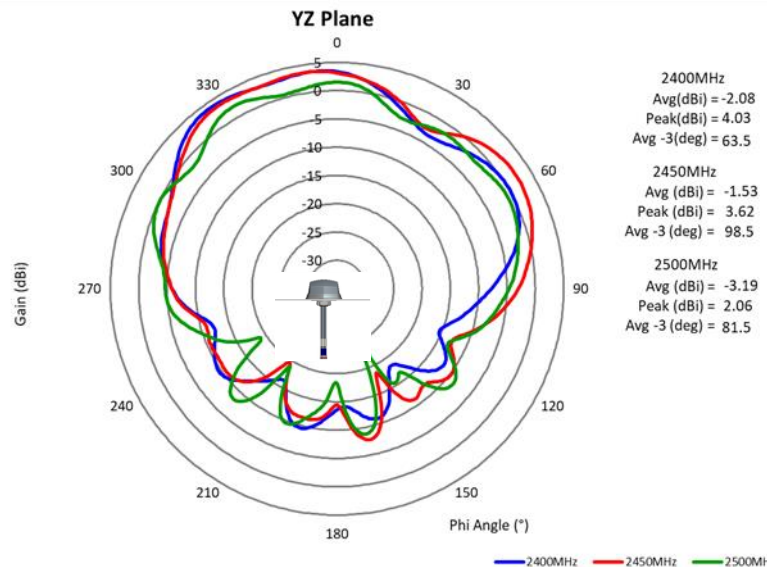

WiFi3 YZ plane radiation pattern

Issue: 2111

In the effort to improve our products, we reserve the right to make changes judged to be necessary.

CONFIDENTIAL AND PROPRIETARY INFORMATION

This document contains confidential and proprietary information of Pulse Electronics, Inc. (Pulse) and is protected by copyright, trade secret and other state and federal laws. Its receipt or possession does not convey any rights to reproduce, disclose its contents, or to manufacture, use or sell anything it may describe. Reproduction, disclosure or use without specific written authorization of Pulse is strictly forbidden.

Description: 5G-FR1/WiFi/GNSS Low Profile Vehicular Multiband Antenna

Series: ARMADILLO

PART NUMBER: ARM5GXXXXDM

CHARTS

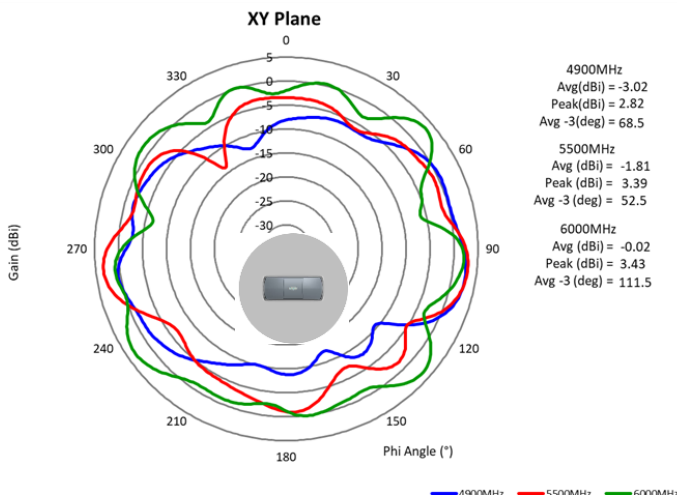

WiFi1 XY plane radiation pattern

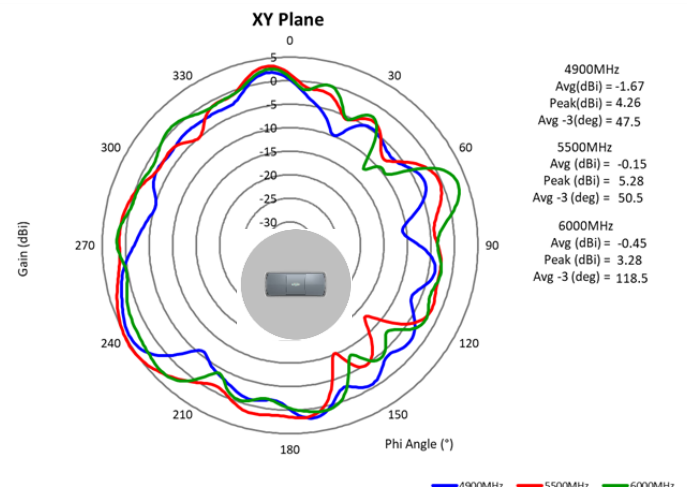

WiFi2 XY plane radiation pattern

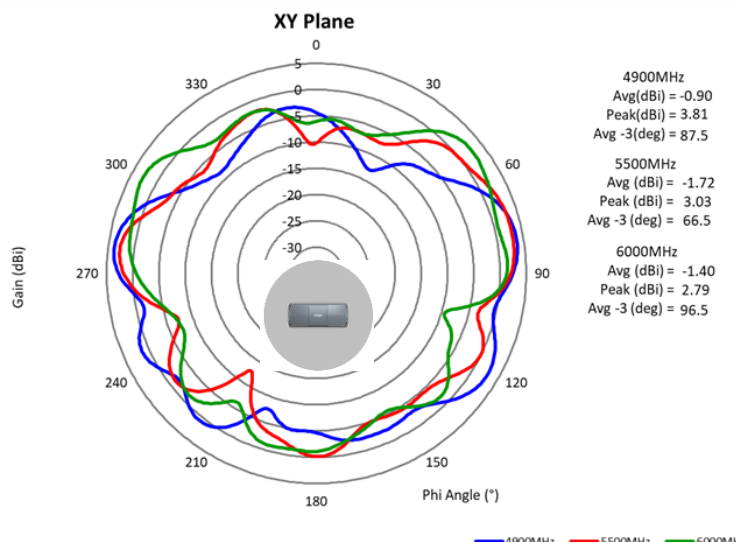

WiFi3 XY plane radiation pattern

Issue: 2111

In the effort to improve our products, we reserve the right to make changes judged to be necessary.

CONFIDENTIAL AND PROPRIETARY INFORMATION

This document contains confidential and proprietary information of Pulse Electronics, Inc. (Pulse) and is protected by copyright, trade secret and other state and federal laws. Its receipt or possession does not convey any rights to reproduce, disclose its contents, or to manufacture, use or sell anything it may describe. Reproduction, disclosure or use without specific written authorization of Pulse is strictly forbidden.

Description: 5G-FR1/WiFi/GNSS Low Profile Vehicular Multiband Antenna

Series: ARMADILLO

PART NUMBER: ARM5GXXXXDM

CHARTS

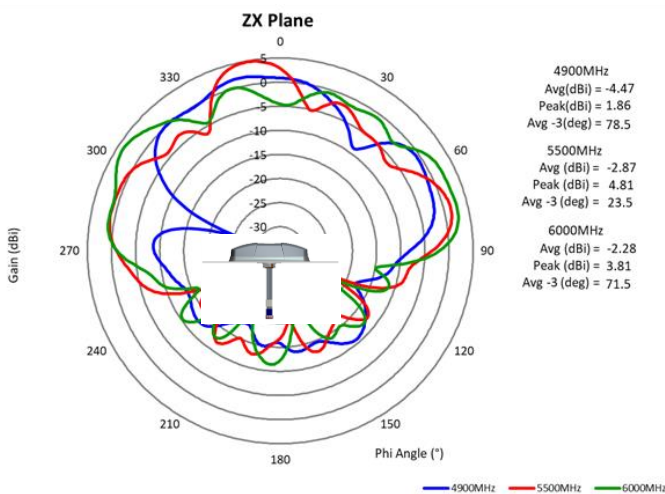

WiFi1 ZX plane radiation pattern

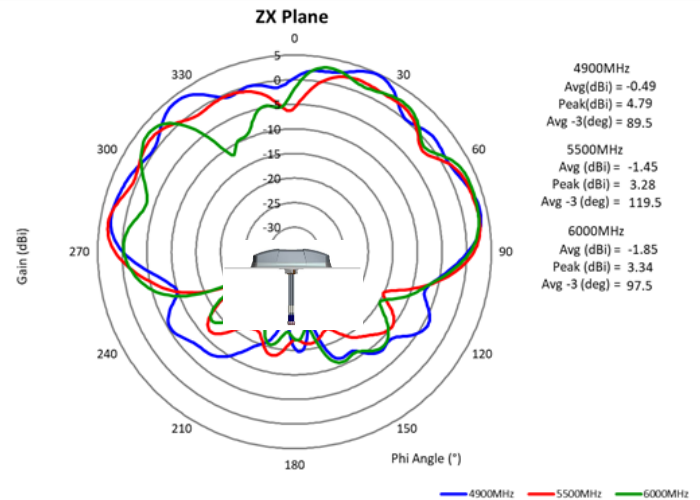

WiFi2 ZX plane radiation pattern

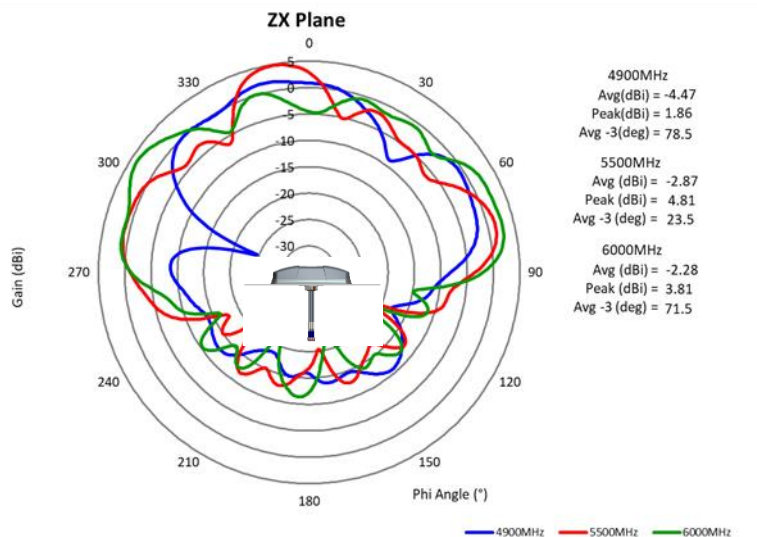

WiFi3 ZX plane radiation pattern

Issue: 2111

In the effort to improve our products, we reserve the right to make changes judged to be necessary.

CONFIDENTIAL AND PROPRIETARY INFORMATION

This document contains confidential and proprietary information of Pulse Electronics, Inc. (Pulse) and is protected by copyright, trade secret and other state and federal laws. Its receipt or possession does not convey any rights to reproduce, disclose its contents, or to manufacture, use or sell anything it may describe. Reproduction, disclosure or use without specific written authorization of Pulse is strictly forbidden.

Description: 5G-FR1/WiFi/GNSS Low Profile Vehicular Multiband Antenna

Series: ARMADILLO

PART NUMBER: ARM5GXXXXDM

CHARTS

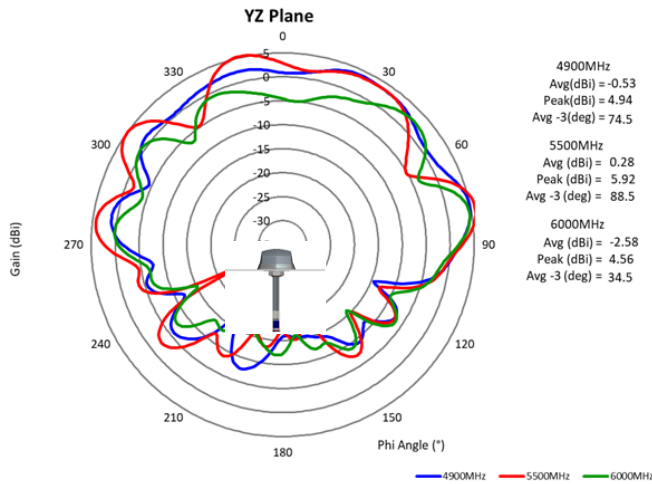

WiFi1 YZ plane radiation pattern

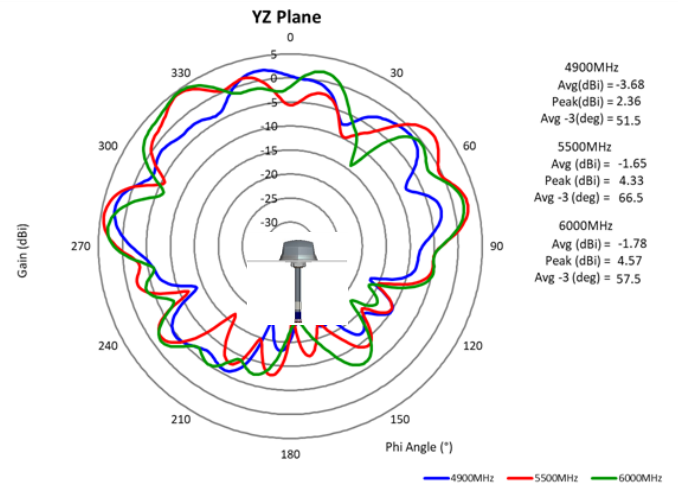

WiFi2 YZ plane radiation pattern

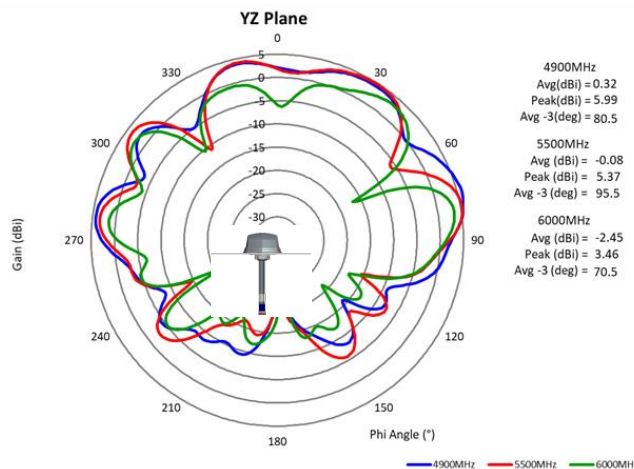

WiFi3 YZ plane radiation pattern

Issue: 2111

In the effort to improve our products, we reserve the right to make changes judged to be necessary.

CONFIDENTIAL AND PROPRIETARY INFORMATION

This document contains confidential and proprietary information of Pulse Electronics, Inc. (Pulse) and is protected by copyright, trade secret and other state and federal laws. Its receipt or possession does not convey any rights to reproduce, disclose its contents, or to manufacture, use or sell anything it may describe. Reproduction, disclosure or use without specific written authorization of Pulse is strictly forbidden.

Description: 5G-FR1/WiFi/GNSS Low Profile Vehicular Multiband Antenna

Series: ARMADILLO

PART NUMBER: ARM5GXXXXDM

CHARTS

LNA Gain and out-of-band rejection

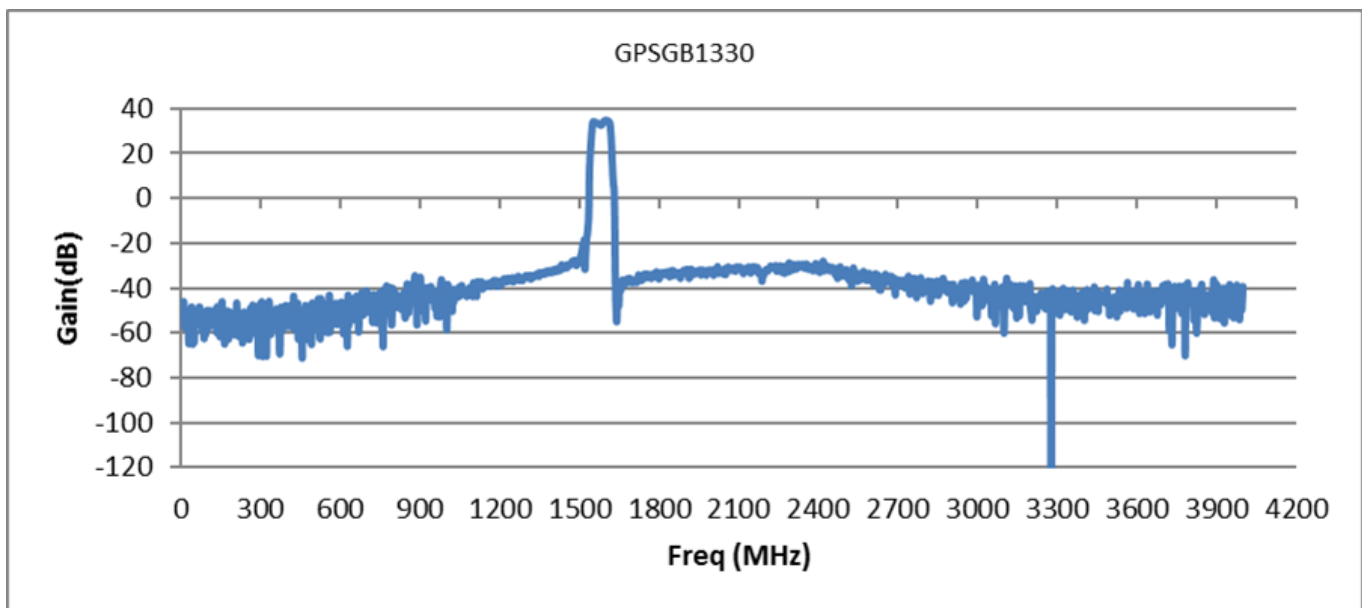

WiFi3 YZ plane radiation pattern

Issue: 2111

In the effort to improve our products, we reserve the right to make changes judged to be necessary.

CONFIDENTIAL AND PROPRIETARY INFORMATION

This document contains confidential and proprietary information of Pulse Electronics, Inc. (Pulse) and is protected by copyright, trade secret and other state and federal laws. Its receipt or possession does not convey any rights to reproduce, disclose its contents, or to manufacture, use or sell anything it may describe. Reproduction, disclosure or use without specific written authorization of Pulse is strictly forbidden.

Description: 5G-FR1/WiFi/GNSS Low Profile Vehicular Multiband Antenna

Series: ARMADILLO

PART NUMBER: ARM5GXXXXDM

CHARTS

Radiation Pattern (70mm x 70mm ground plane) GPS & Galileo

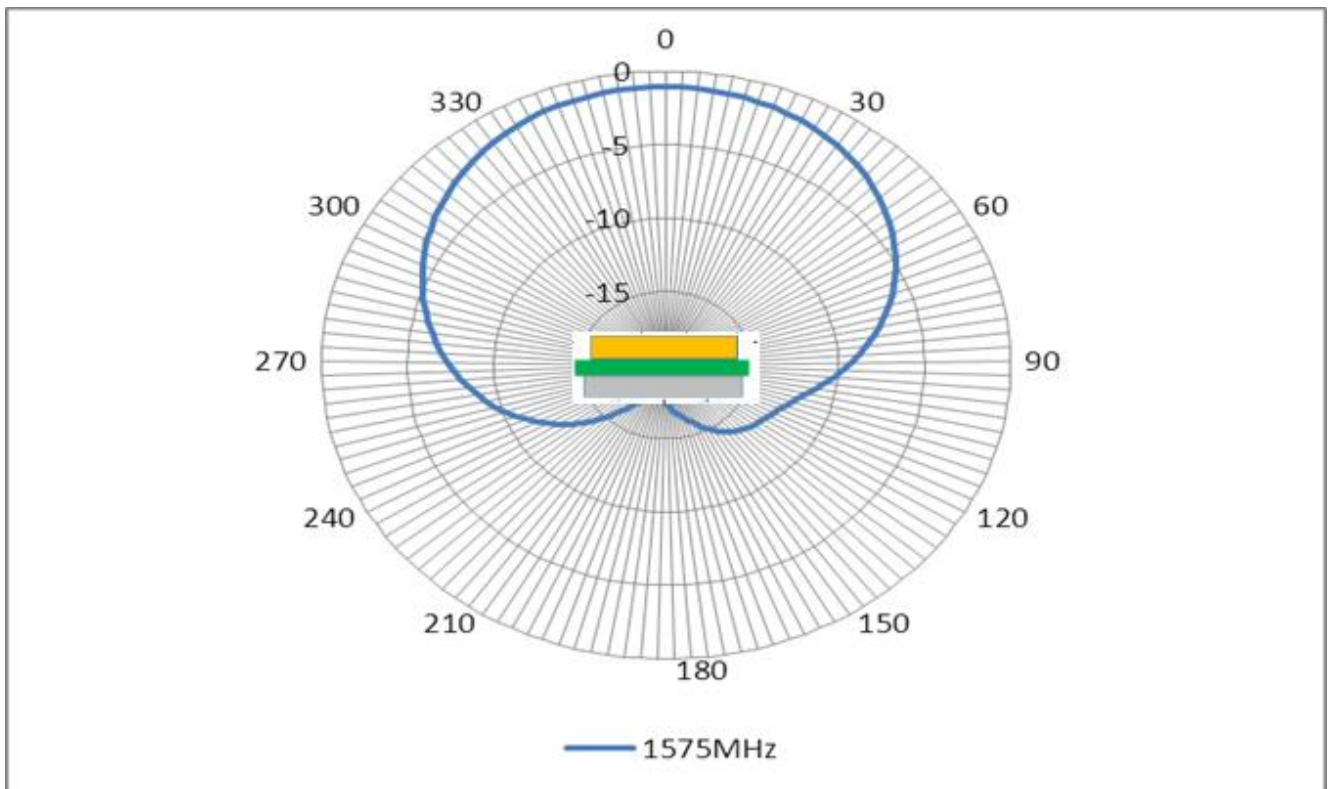

WiFi3 YZ plane radiation pattern

Issue: 2111

In the effort to improve our products, we reserve the right to make changes judged to be necessary.

CONFIDENTIAL AND PROPRIETARY INFORMATION

This document contains confidential and proprietary information of Pulse Electronics, Inc. (Pulse) and is protected by copyright, trade secret and other state and federal laws. Its receipt or possession does not convey any rights to reproduce, disclose its contents, or to manufacture, use or sell anything it may describe. Reproduction, disclosure or use without specific written authorization of Pulse is strictly forbidden.

Description: 5G-FR1/WiFi/GNSS Low Profile Vehicular Multiband Antenna

Series: ARMADILLO

PART NUMBER: ARM5GXXXXDM

CHARTS

Radiation Pattern (70mm x 70mm ground plane) GLONASS

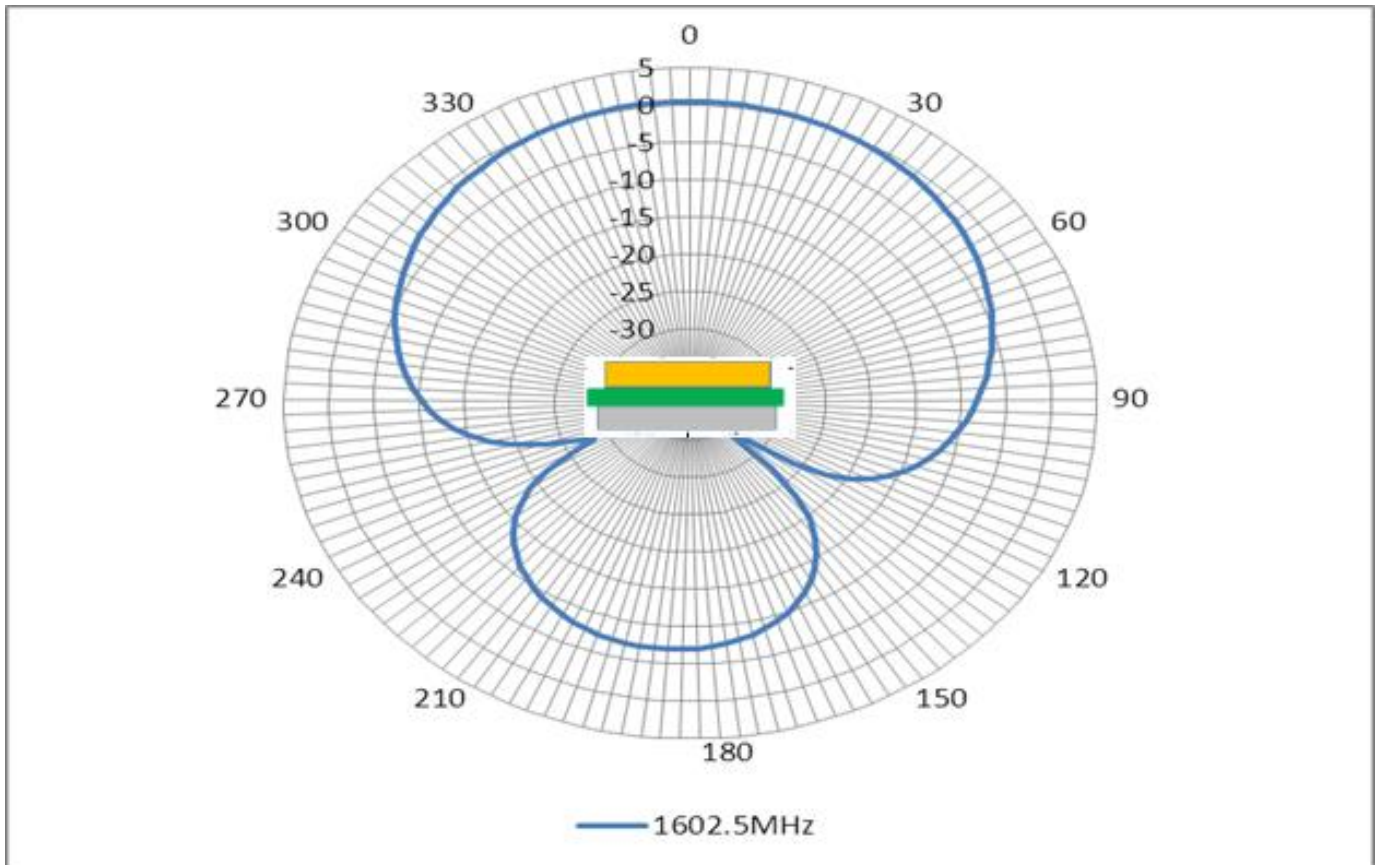

WiFi3 YZ plane radiation pattern

Issue: 2111

In the effort to improve our products, we reserve the right to make changes judged to be necessary.

CONFIDENTIAL AND PROPRIETARY INFORMATION

This document contains confidential and proprietary information of Pulse Electronics, Inc. (Pulse) and is protected by copyright, trade secret and other state and federal laws. Its receipt or possession does not convey any rights to reproduce, disclose its contents, or to manufacture, use or sell anything it may describe. Reproduction, disclosure or use without specific written authorization of Pulse is strictly forbidden.

Description: 5G-FR1/WiFi/GNSS Low Profile
Vehicular Multiband Antenna

Series: ARMADILLO

PART NUMBER: ARM5GXXXXDM

PACKAGING

Each antennas packed in Bubble Bag

6 bags of antennas (Total 6pcs) packed in a cardboard box

1 label on each box with quantity, part number, date code.