

BFSI Series



Features

- Shield construction
- Flat wire winding, achieve a low dc resistance
- Low loss, High efficiency, wide application frequency and application scope
- Lightweight design, save a space, suitable for high density SMT
- Heat dissipation

Applications

- Umpc/NBPC
- Desk Top/LCD monitor
- PDA/Lap Top
- Server systems/Computer lord plank
- Mobile Phone/ DV/HDD

Product Identification

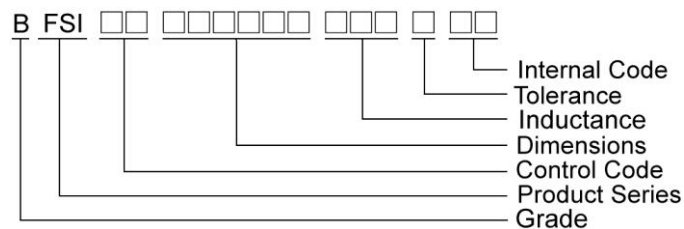

Shapes and Dimensions

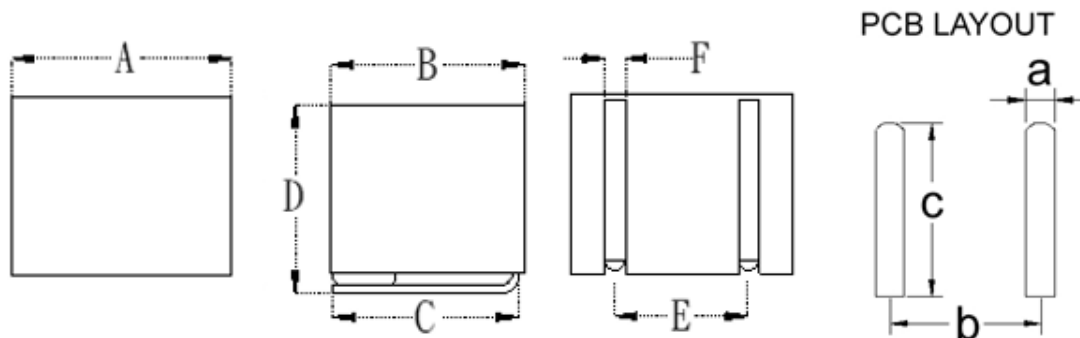

Dimensions in mm

TYPE	A	B	C	D	E	F	a	b	c
BFSI00090908	9.3Max	9.0Max	6.7±0.3	8.1±0.4	6.0±0.4	1.2±0.1	1.6	6	8
BFSI00121109	12±0.5	11±0.5	8.4±0.3	8.8Max	8.0±0.4	1.6±0.1	2.0	8	10

SMD Power Chokes – BFSI Series

Electrical Characteristics

Part Number	Inductance (μH)	Tolerance (±%)	Test Frequency (kHz)	RDC(mΩ) Max(Typ)	Isat (A)Typ.	Irms (A)Typ.
BFSI00090908R68M05	0.68	20	100/1V	2(1.3)	38	36
BFSI000909081R0M05	1.0	20	100/1V	2.5(1.7)	31	34
BFSI000909081R5M05	1.5	20	100/1V	3.5(2.5)	28	28
BFSI000909082R2M05	2.2	20	100/1V	3.8(2.9)	24	25
BFSI000909083R3M05	3.3	20	100/1V	6.5(5.6)	19	17.5
BFSI000909084R7M05	4.7	20	100/1V	8.5(7)	17.5	15
BFSI000909086R8M05	6.8	20	100/1V	13(12)	14	12
BFSI000909088R2M05	8.2	20	100/1V	15(13.3)	12	11
BFSI00090908100M05	10	20	100/1V	15.5(13.8)	11	10

Note: When ordering, please specify tolerance code. Tolerance: M=±20%

- Customized Specifications are welcome
- Isat for Inductance drop 30% from its value with current
- Irms for a 40°C temperature rise from 25°C ambient with current
- Apply glue around the product to fix the product body after loading the plate
- Measure Equipment :
 L : WK4237
 RDC : CHEN HWA502
 Isat & Irms : WK3260B/ 3265

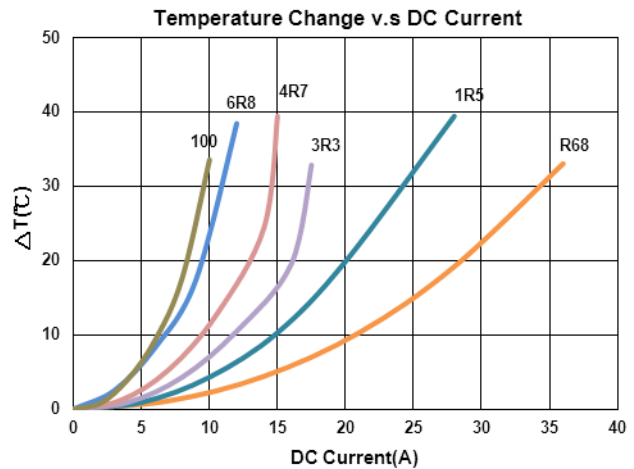
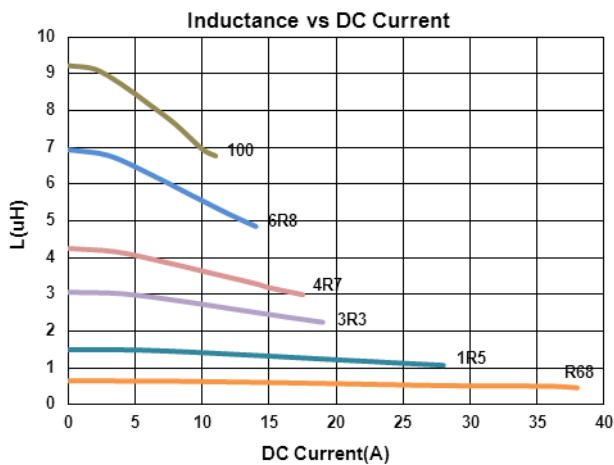

SMD Power Chokes – BFSI Series

Electrical Characteristics

Part Number	Inductance (μH)	Tolerance (±%)	Test Frequency (kHz)	RDC(mΩ) Max(Typ)	Isat (A)Typ.	Irms (A)Typ.
BFSI00121109R47M05	0.47	20	100/1V	1.5(1.1)	65	50
BFSI001211091R0M05	1.0	20	100/1V	2.0(1.5)	45	40
BFSI001211091R5M05	1.5	20	100/1V	2.5(2.0)	36	33
BFSI001211092R2M05	2.2	20	100/1V	2.8(2.4)	30	30
BFSI001211093R3M05	3.3	20	100/1V	3.8(3.3)	26	26
BFSI001211094R7M05	4.7	20	100/1V	6.2(5.7)	23	20
BFSI001211095R6M05	5.6	20	100/1V	7.0(6.4)	21	18
BFSI001211096R8M05	6.8	20	100/1V	7.8(6.8)	19	17
BFSI001211098R2M05	8.2	20	100/1V	9.0(8.2)	18	16
BFSI00121109100M05	10	20	100/1V	12(11.3)	17.5	13
BFSI00121109150M05	15	20	100/1V	15(14.3)	13.5	11

Note: When ordering, please specify tolerance code. Tolerance: M=±20%

- Customized Specifications are welcome
- Isat for Inductance drop 30% from its value with current
- Irms for a 40°C temperature rise from 25°C ambient with current
- Apply glue around the product to fix the product body after loading the plate
- Measure Equipment :
 L : WK4237
 RDC : CHEN HWA502
 Isat & Irms : WK3260B/ 3265

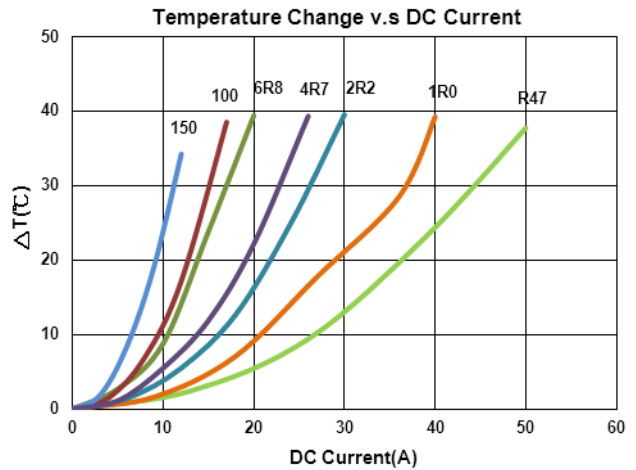
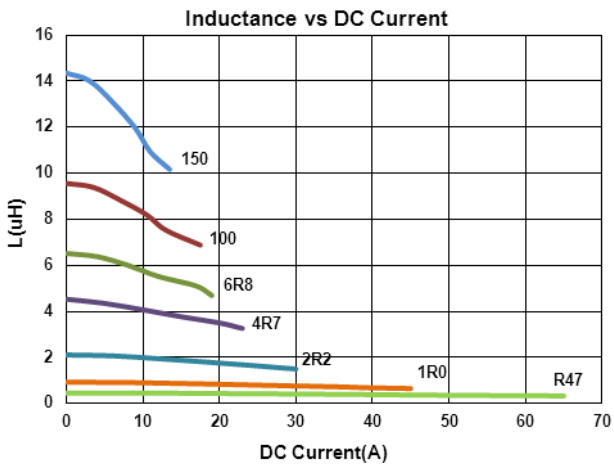

Please be sure to request approval specifications that provide further details of the products. Kindly note that the content of these specifications are subject to change or may be discontinued without prior notice. This product may not be designed/used in medical or high risk applications without Chilisin approval. Please contact our sales department before ordering.

SMD Power Chokes – BFSI Series

Packaging

Tape Dimensions

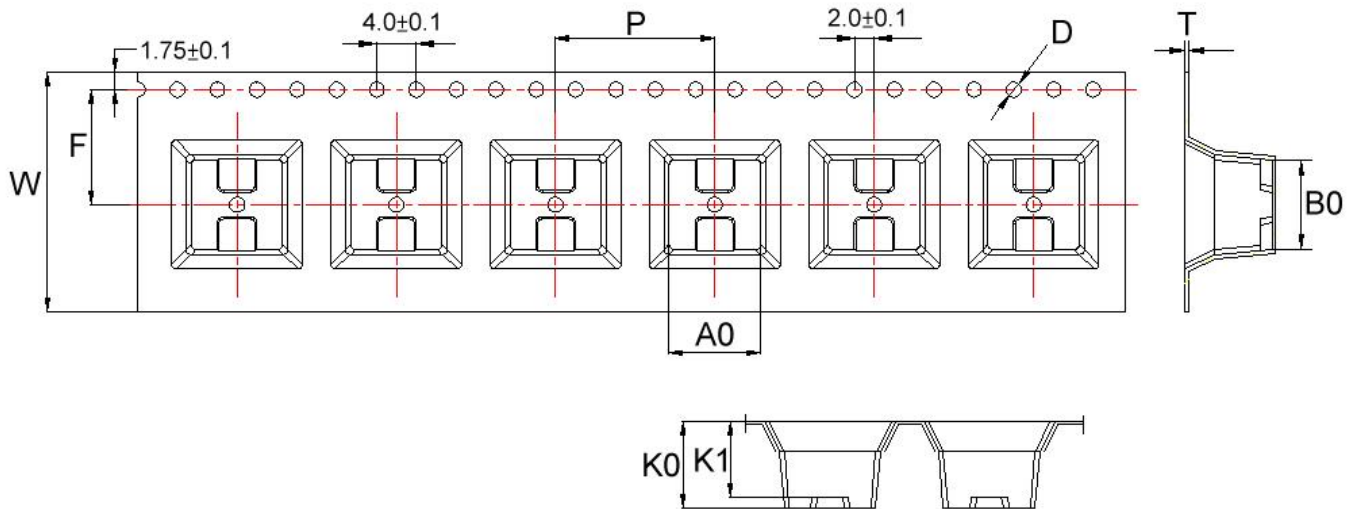

Reel Dimensions

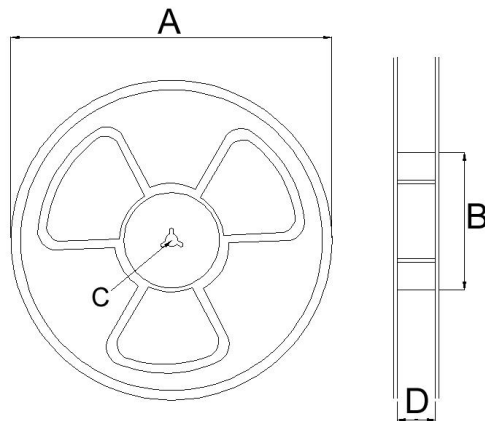

Dimensions in mm

TYPE	Tape Dimensions									Reel Dimensions				Quantity
	A0	B0	K0	K1	D	F	W	T	P	A	B	C	D	PCS / REEL
BFSI00090908	9.2	9	8.8	7.60	1.5	11.5	24	0.4	16	330	100	13	24.3	300
BFSI00121109	12.2	11	9.0	8.07	1.5	11.5	24	0.5	20	330	100	13	24.3	240