

BMMA Series



BMMA Series is designed for low profile type with low RDC and ultra large current. Its molded magnetic shielded type is suitable for high-density mounting and ultra low buzz noise. Soldering conditions can be easily confirmed when mounting onto the board. This series also provides customers with embossed carrier type packaging for automatic mounting machine.

Features

- RoHS, Halogen Free and REACH Compliance
- Low resistance and high current rating
- Magnetic core made by high performance magnetic powder

Applications

- Laptop and desktop applications
- High current power supplies
- PMIC
- DC/DC converters

Product Identification

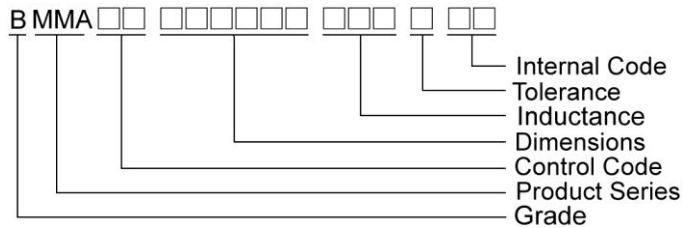

Shape and Dimensions

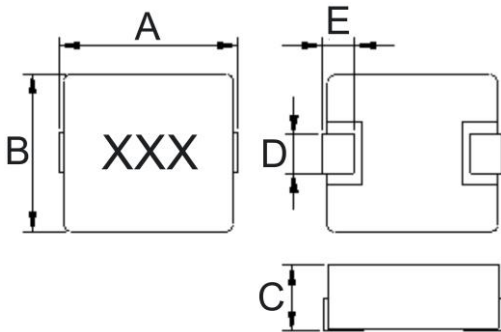

Dimensions in mm

TYPE	A	B	C	D	E
BMMA00040412-X2	4.45±0.25	4.06±0.25	1.2Max	2.0±0.3	0.76±0.3
BMMA00040412-V1	4.45±0.25	4.06±0.25	1.2Max	2.0±0.3	0.76±0.3
BMMA00040420-X2	4.45±0.25	4.06±0.25	2.0Max	2.0±0.3	0.76±0.3
BMMA00040420-V1	4.45±0.25	4.06±0.25	2.0Max	2.0±0.3	0.76±0.3
BMMA00040420-I8	4.45±0.25	4.06±0.25	2.0Max	2.0±0.3	0.76±0.3
BMMA00050512-V1	5.49±0.25	5.18±0.22	1.2Max	2.0±0.3	1.0±0.3
BMMA00050518-X2	5.49±0.25	5.18±0.22	1.8Max	2.0±0.3	1.0±0.3
BMMA00050520-X1	5.49±0.25	5.18±0.25	2.0Max	2.0±0.3	1.02±0.3
BMMA00050520-V1	5.49±0.25	5.18±0.22	2.0Max	2.0±0.3	1.0±0.3

Recommended Pattern

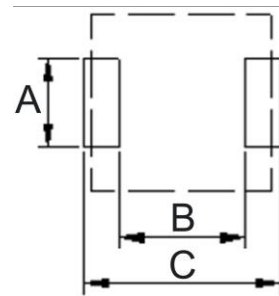

Dimensions in mm

TYPE	A	B	C
BMMA00040412-X2	2.5	2.2	5.2
BMMA00040412-V1	2.3	1.65	4.95
BMMA00040420-X2	2.5	2.2	5.2
BMMA00040420-V1	2.3	1.65	4.95
BMMA00040420-I8	2.3	1.65	4.95
BMMA00050512-V1	2.79	2.16	5.99
BMMA00050518-X2	2.5	2.2	5.99
BMMA00050520-X1	2.79	2.16	5.99
BMMA00050520-V1	2.79	2.16	5.99

Shape and Dimensions

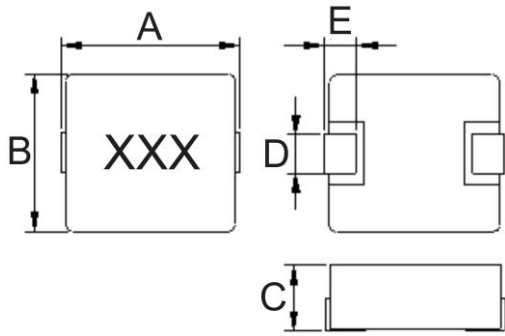

Dimensions in mm

TYPE	A	B	C	D	E
BMMA00050530-Xx	5.3Max	4.7±0.2	3.0Max	2.0±0.2	1.0±0.3
BMMA00050530-V1	5.49±0.25	5.18±0.22	3.0Max	2.0±0.3	1.0±0.3
BMMA00060618-X2	7.4Max	6.6±0.2	1.8Max	3.0±0.3	1.6±0.3
BMMA00060618-V1	6.86±0.38	6.47±0.25	1.8Max	3.18±0.3	1.3±0.3
BMMA00060624-X2	7.5Max	6.6±0.2	2.4Max	3.0±0.5	1.3±0.5
BMMA00060624-V1	6.86±0.38	6.47±0.25	2.4Max	3.18±0.3	1.3±0.3
BMMA00060630-Xx	6.95±0.35	6.6±0.2	3.0Max	3.0±0.3	1.6±0.3
BMMA00060630-V1	6.86±0.38	6.47±0.25	3.0Max	3.18±0.3	1.3±0.3
BMMA00060640	6.95±0.35	6.6±0.2	4.0Max	3.0±0.3	1.6±0.3
BMMA00060650-X1	6.95±0.35	6.6±0.2	5.0Max	3.0±0.3	1.6±0.3
BMMA00060650-X2	7.4Max	6.6±0.2	5.0Max	3.0±0.5	1.6±0.3
BMMA00060650-V1	6.86±0.38	6.47±0.25	5.0Max	3.18±0.3	1.3±0.3
BMMA00080830	8.3±0.3	8.1±0.3	3.0Max	3.0±0.3	1.5±0.3
BMMA00080840	8.3±0.3	8.1±0.3	4.0Max	3.0±0.3	1.5±0.3
BMMA00101015	11.5Max	10±0.3	1.5Max	3.0±0.5	2.0±0.5
BMMA00101030	11.5Max	10±0.3	3.0Max	3.0±0.5	2.0±0.5
BMMA00101040	11.5Max	10±0.3	4.0Max	3.0±0.5	2.0±0.5
BMMA00101040-I8	11.5Max	10±0.3	4.0Max	3.0±0.5	2.2±0.3
BMMA00101045	11.5Max	10±0.3	4.5Max	3.0±0.5	2.0±0.5
BMMA00101050	11.5Max	10±0.3	5.0Max	3.0±0.5	2.0±0.5
BMMA00131335	13.2±0.5	12.9Max	3.5Max	3.5±0.5	2.3±0.3
BMMA00131350-X1	13.2±0.5	12.9Max	5.0Max	3.5±0.5	2.3±0.3
BMMA00131350-X2	13.2±0.5	12.6±0.2	5.0Max	3.5±0.5	2.3±0.3
BMMA00131350-V1	13.2±0.5	12.9Max	5.0Max	3.5±0.5	2.3±0.3
BMMA00131364	13.2±0.5	12.9Max	6.4Max	3.5±0.5	2.3±0.3
BMMA00171770	17.6±0.5	17.2Max	7.0Max	11.8±0.3	2.5±0.5

Recommended Pattern

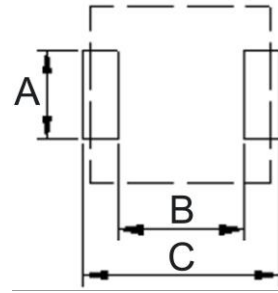

Dimensions in mm

TYPE	A	B	C
BMMA00050530-Xx	2.5	3.0	7.0
BMMA00050530-V1	2.79	2.16	5.99
BMMA00060618-X2	3.5	3.7	8.4
BMMA00060618-V1	3.43	3.71	7.37
BMMA00060624-X2	3.5	3.7	8.4
BMMA00060624-V1	3.43	3.71	7.37
BMMA00060630-Xx	3.5	3.7	8.4
BMMA00060630-V1	3.43	3.71	7.37
BMMA00060640	3.5	3.7	8.4
BMMA00060650-Xx	3.5	3.7	8.4
BMMA00060650-V1	3.43	3.71	7.37
BMMA00080830	3.5	4.2	9
BMMA00080840	3.5	4.2	9
BMMA00101015	4.1	5.4	13.6
BMMA00101030	4.1	5.4	13.6
BMMA00101040-Xx	4.1	5.4	13.6
BMMA00101040-V1	4	6	13
BMMA00101040-I8	4.1	5.4	13.6
BMMA00101045	4.1	5.4	13.6
BMMA00101050	4.1	5.4	13.6
BMMA00131335-X1	5	8	14.5
BMMA00131335-V1	4.95	7.87	13.76
BMMA00131350	5	8	14.5
BMMA00131350_V1	4.95	7.87	13.76
BMMA00131364	4.95	7.87	13.76
BMMA00171770	12.8	11.2	18.2

Molding Power Inductors – BMMA Series

Electrical Characteristics

Part Number	Inductance (uH)	Tolerance (±%)	Test Frequency (kHz)	RDC(mΩ) Max(Typ.)	Isat (A)Typ.	Irms (A)Typ.	Marking
BMMA00040412R47MX2	0.47	20	100	21(19)	6.8	6	R47

Note: When ordering, please specify tolerance code. Tolerance: M=±20%

- Operating temperature range—55°C ~ 125°C (Including self - temperature rise)
- Isat for Inductance drop 30% from its value without current
- I rms for a 40°C temperature rise from 25°C ambient with current
- Withstand voltage: 25V DC
- Measure Equipment :
 L : WK 3260B or WK 6500P, 100kHz 0.25V
 RDC : CHEN HWA 502 or CHEN HWA 46502B
 I rms : CHROMA 1810

Test Instruments : WK3260B Impedance / Material Analyzer

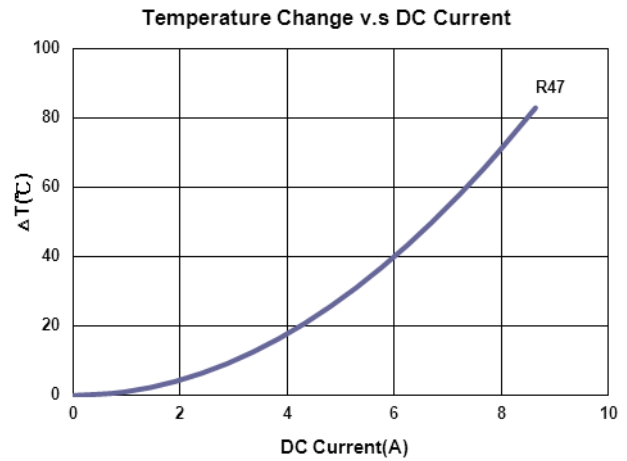
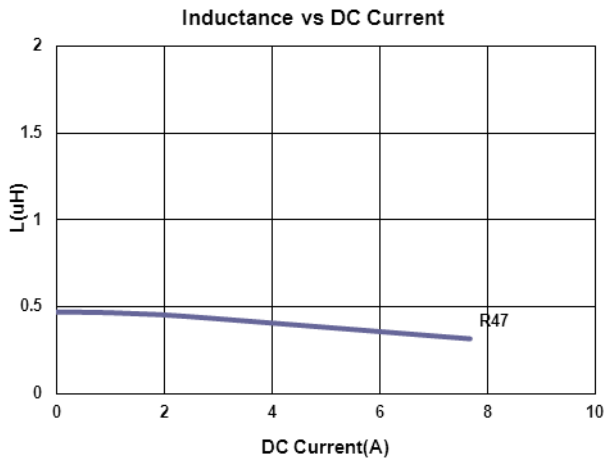

Molding Power Inductors – BMMA Series

Electrical Characteristics

Part Number	Inductance (uH)	Tolerance (±%)	Test Frequency (kHz)	RDC(mΩ) Max(Typ.)	Isat (A)Typ.	Irms (A)Typ.	Marking
BMMA0004041247NMV1	0.047	20	100	3.75(3.25)	32	13	47N
BMMA00040412R10MV1	0.10	20	100	6(5.5)	25	11.5	R10
BMMA00040412R22MV1	0.22	20	100	12(11)	20	8.5	R22
BMMA00040412R47MV1	0.47	20	100	22(20)	13	5	R47
BMMA00040412R68MV1	0.68	20	100	31.4(29.3)	9.3	4.9	R68
BMMA000404121R0MV1	1.0	20	100	52.5(50)	8.5	4	1R0

Note: When ordering, please specify tolerance code. Tolerance: M=±20%

- Operating temperature range –55°C ~ 125°C (Including self - temperature rise)
- Isat for Inductance drop 20% from its value without current
- I rms for a 40°C temperature rise from 25°C ambient with current
- Withstand voltage: 25V DC
- Measure Equipment :
 L : WK 3260B or WK 6500P, 100kHz 0.25V
 RDC : CHEN HWA 502 or CHEN HWA 46502B
 I rms : CHROMA 1810

Test Instruments : WK3260B Impedance / Material Analyzer

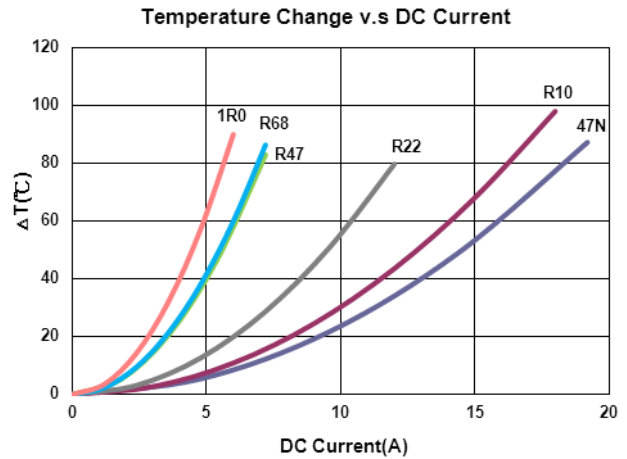
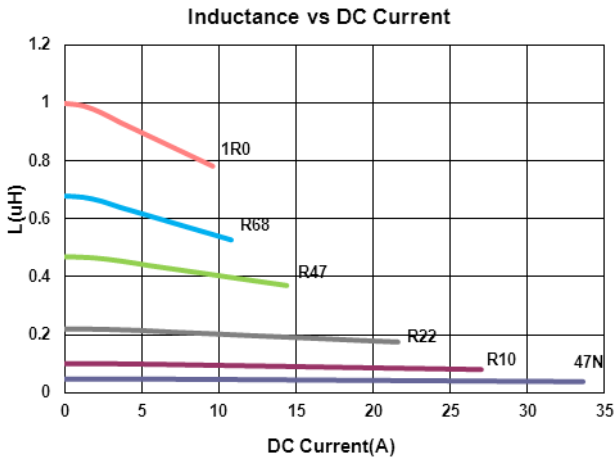

Molding Power Inductors – BMMA Series

Electrical Characteristics

Part Number	Inductance (uH)	Tolerance (±%)	Test Frequency (kHz)	RDC(mΩ) Max(Typ.)	Isat (A)Typ.	Irms (A)Typ.	Marking
BMMA00040420R10MX2	0.10	20	100	4(3.5)	22	12	R10
BMMA00040420R22MX2	0.22	20	100	6.6(6)	12.5	9	R22
BMMA00040420R47MX2	0.47	20	100	14(12.5)	9.5	7	R47
BMMA00040420R56MX2	0.56	20	100	16(14)	10	6.5	R56
BMMA00040420R68MX2	0.68	20	100	18(16)	9	6	R68
BMMA000404201R0MX2	1.0	20	100	27(24)	7	4.5	1R0
BMMA000404201R5MX2	1.5	20	100	43(35)	6	4	1R5
BMMA000404202R2MX2	2.2	20	100	58(52)	5	3	2R2
BMMA000404203R3MX2	3.3	20	100	87(74)	4	2.5	3R3
BMMA000404204R7MX2	4.7	20	100	105(92)	3	2.2	4R7

Note: When ordering, please specify tolerance code. Tolerance: M=±20%

- Operating temperature range –55°C ~ 125°C (Including self - temperature rise)
- Isat for Inductance drop 30% from its value without current
- I rms for a 40°C temperature rise from 25°C ambient with current
- Withstand voltage: 25V DC
- Measure Equipment :
 L : WK 3260B or WK 6500P, 100kHz 0.25V
 RDC : CHEN HWA 502 or CHEN HWA 46502B
 I rms : CHROMA 1810

Test Instruments : WK3260B Impedance / Material Analyzer

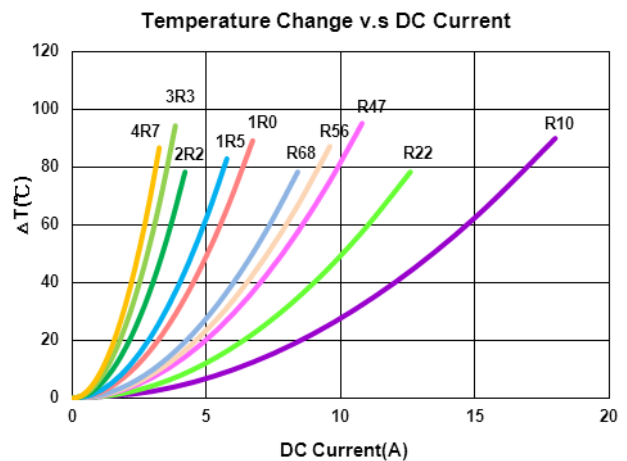
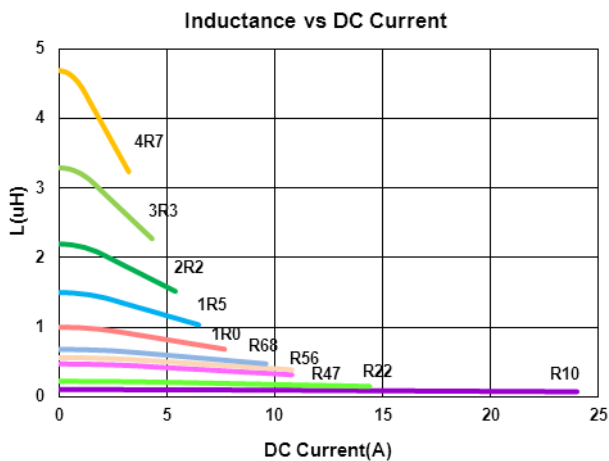

Please be sure to request approval specifications that provide further details of the products. Kindly note that the content of these specifications are subject to change or may be discontinued without prior notice. This product may not be designed/used in medical or high risk applications without Chilisin approval. Please contact our sales department before ordering.

Molding Power Inductors – BMMA Series

Electrical Characteristics

Part Number	Inductance (uH)	Tolerance (±%)	Test Frequency (kHz)	RDC(mΩ) Max(Typ.)	Isat (A)Typ.	Irms (A)Typ.	Marking
BMMA00040420R10MV1	0.10	20	100	5(4.5)	35	16	R10
BMMA00040420R22MV1	0.22	20	100	8(7.3)	24	13	R22
BMMA00040420R47MV1	0.47	20	100	18(16)	11.5	5.6	R47
BMMA000404201R0MV1	1.0	20	100	37(33)	8.5	3.75	1R0
BMMA000404202R2MV1	2.2	20	100	90(80)	6	2.85	2R2

Note: When ordering, please specify tolerance code. Tolerance: M=±20%

- Operating temperature range – 55°C ~ 125°C (Including self - temperature rise)
- Isat for Inductance drop 20% from its value without current
- I rms for a 40°C temperature rise from 25°C ambient with current
- Withstand voltage: 25V DC
- Measure Equipment :
 L : WK 3260B or WK 6500P, 100kHz 0.25V
 RDC : CHEN HWA 502 or CHEN HWA 46502B
 I rms : CHROMA 1810

Test Instruments : WK3260B Impedance / Material Analyzer

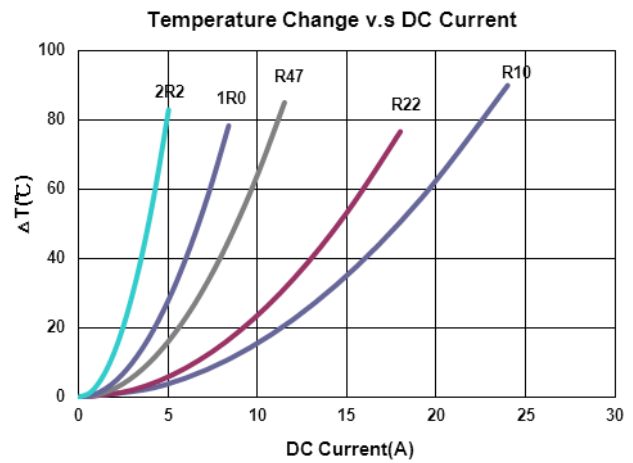
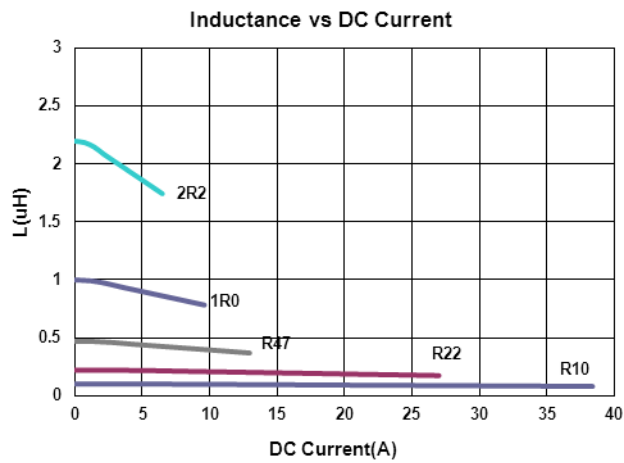

Molding Power Inductors – BMMA Series

Electrical Characteristics

Part Number	Inductance (uH)	Tolerance (±%)	Test Frequency (kHz)	RDC (mΩ)±10%	Isat (A)Typ.	Irms (A)Typ.	Marking
BMMA00040420R47MI8	0.47	20	100	12.7	12	8	R47

Note: When ordering, please specify tolerance code. Tolerance: M=±20%

- Operating temperature range—55°C ~ 125°C (Including self - temperature rise)
- Isat for Inductance drop 25% from its value without current
- I rms for a 40°C temperature rise from 25°C ambient with current
- Withstand voltage: 25V DC
- Measure Equipment :
 L : WK 3260B or WK 6500P, 100kHz 0.25V
 RDC : CHEN HWA 502 or CHEN HWA 46502B
 I rms : CHROMA 1810

Test Instruments : WK3260B Impedance / Material Analyzer

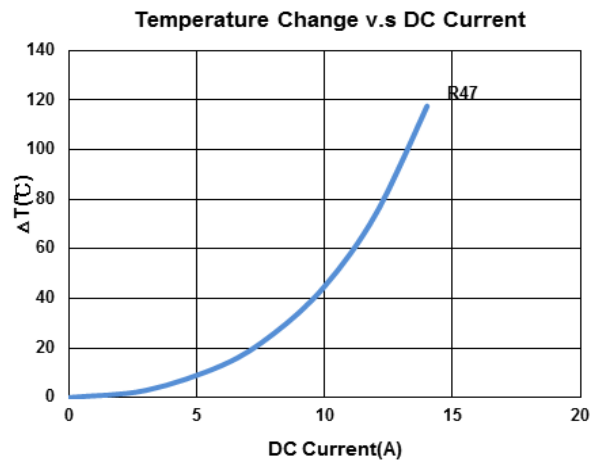
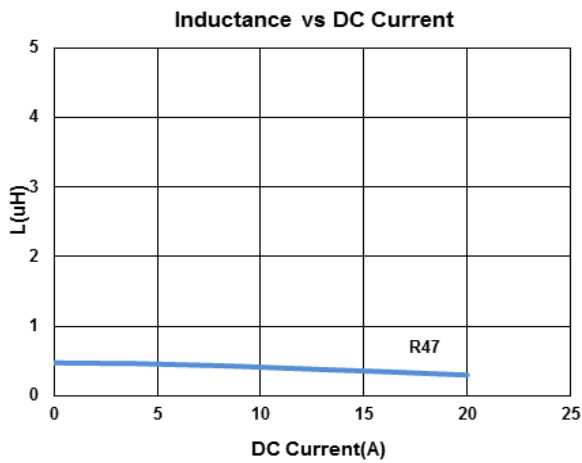

Molding Power Inductors – BMMA Series

Electrical Characteristics

Part Number	Inductance (uH)	Tolerance (±%)	Test Frequency (kHz)	RDC(mΩ) Max(Typ.)	Isat (A)Typ.	Irms (A)Typ.	Marking
BMMA000505121R0MV1	1.0	20	100	46.5(44.3)	10.2	4.4	1R0
BMMA000505122R2MV1	2.2	20	100	77.3(73.6)	6	3.4	2R2
BMMA000505123R3MV1	3.3	20	100	103(98.4)	5	2.8	3R3

Note: When ordering, please specify tolerance code. Tolerance: M=±20%

- Operating temperature range – 55°C ~ 125°C (Including self - temperature rise)
- Isat for Inductance drop 20% from its value without current
- I rms for a 40°C temperature rise from 25°C ambient with current
- Withstand voltage: 25V DC
- Measure Equipment :
 L : WK 3260B or WK 6500P, 100kHz 0.25V
 RDC : CHEN HWA 502 or CHEN HWA 46502B
 I rms : CHROMA 1810

Test Instruments : WK3260B Impedance / Material Analyzer

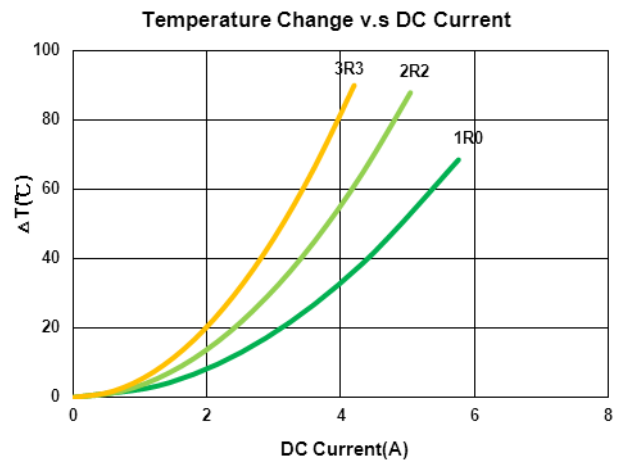
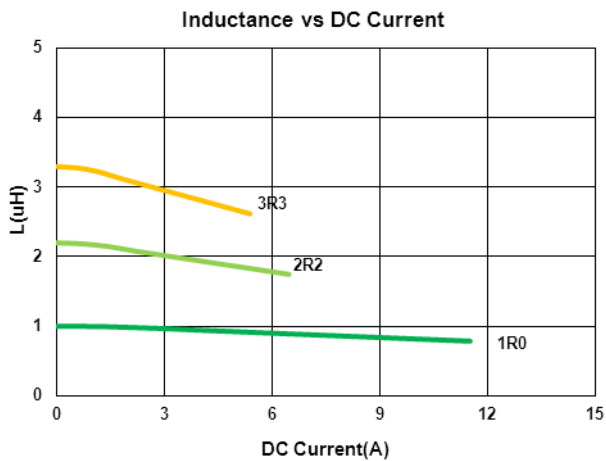

Molding Power Inductors – BMMA Series

Electrical Characteristics

Part Number	Inductance (uH)	Tolerance (±%)	Test Frequency (kHz)	RDC(mΩ) Max(Typ.)	Isat (A)Typ.	Irms (A)Typ.	Marking
BMMA000505181R0MX2	1.0	20	100	17(15)	9	8	1R0
BMMA000505184R7MX2	4.7	20	100	85(78)	4	3.5	4R7
BMMA000505186R8MX2	6.8	20	100	120(107)	3.4	2.8	6R8
BMMA00050518100MX2	10	20	100	155(140)	3	2.5	100

Note: When ordering, please specify tolerance code. Tolerance: M=±20%

- Operating temperature range – 55°C ~ 125°C (Including self - temperature rise)
- Isat for Inductance drop 30% from its value without current
- I rms for a 40°C temperature rise from 25°C ambient with current
- Withstand voltage: 25V DC
- Measure Equipment :
 L : WK 3260B or WK 6500P, 100kHz 0.25V
 RDC : CHEN HWA 502 or CHEN HWA 46502B
 I rms : CHROMA 1810

Test Instruments : WK3260B Impedance / Material Analyzer

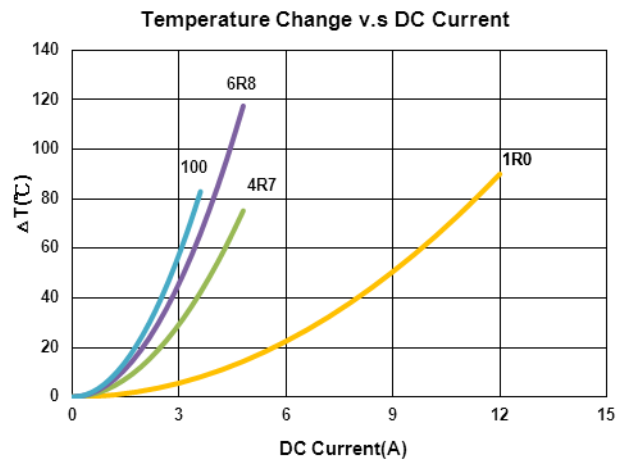
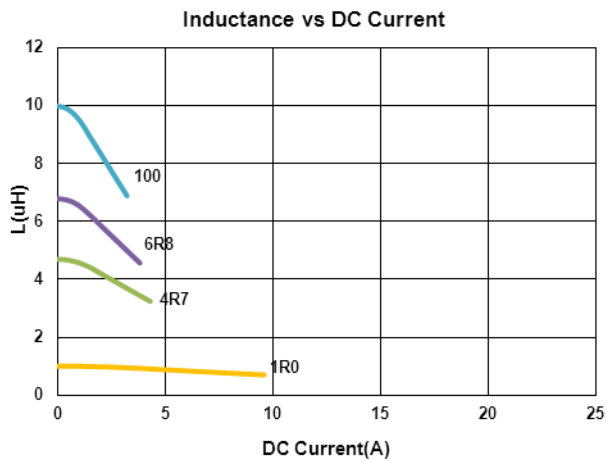

Electrical Characteristics

Part Number	Inductance (uH)	Tolerance (±%)	Test Frequency (kHz)	RDC(mΩ) Max(Typ.)	Isat (A)Typ.	Irms (A)Typ.	Marking
BMMA000505201R0MX1	1.0	20	100	20(18.9)	16	7	1R0

Note: When ordering, please specify tolerance code. Tolerance: M=±20%

- Operating temperature range—55°C ~ 125°C (Including self - temperature rise)
- Isat for Inductance drop 30% from its value without current
- I rms for a 40°C temperature rise from 25°C ambient with current
- Withstand voltage: 25V DC
- Measure Equipment :
 L : WK 3260B or WK 6500P, 100kHz 0.25V
 RDC : CHEN HWA 502 or CHEN HWA 46502B
 I rms : CHROMA 1810

Test Instruments : WK3260B Impedance / Material Analyzer

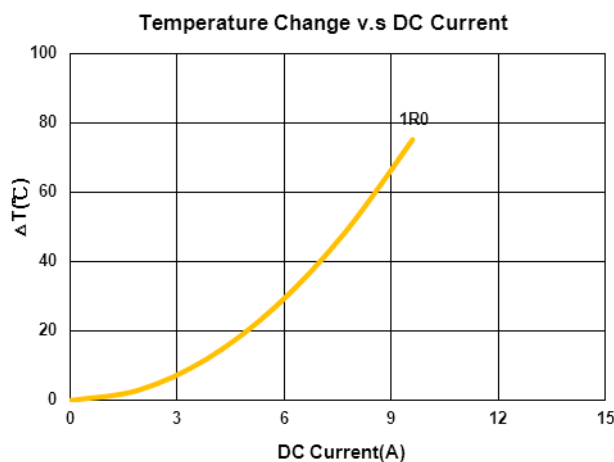
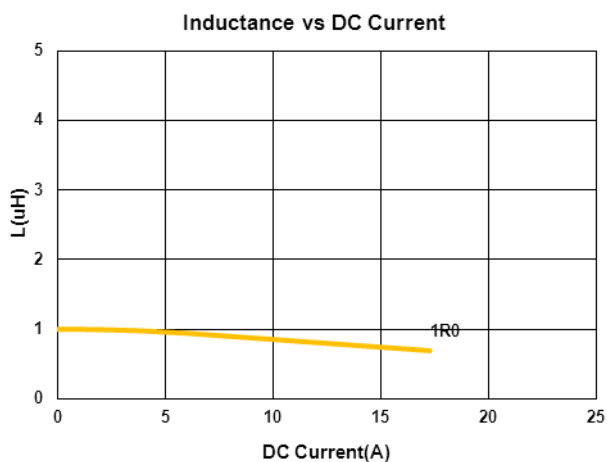

Molding Power Inductors – BMMA Series

Electrical Characteristics

Part Number	Inductance (uH)	Tolerance (±%)	Test Frequency (kHz)	RDC(mΩ) Max(Typ.)	Isat (A)Typ.	Irms (A)Typ.	Marking
BMMA00050520R10MV1	0.10	20	100	3.9(3.6)	45	17	R10
BMMA00050520R33MV1	0.33	20	100	8.2(7.6)	25	12	R33
BMMA00050520R47MV1	0.47	20	100	8.8(8.1)	21	11.5	R47
BMMA000505201R0MV1	1.0	20	100	20(18.9)	16	7	1R0
BMMA000505202R2MV1	2.2	20	100	50.1(45.6)	12.5	4.2	2R2
BMMA000505203R3MV1	3.3	20	100	85.5(79.2)	8.5	3.3	3R3
BMMA000505204R7MV1	4.7	20	100	116.6(108)	5	2.8	4R7
BMMA000505205R6MV1	5.6	20	100	122(113)	4.5	2.5	5R6
BMMA000505206R8MV1	6.8	20	100	150(139)	4.3	2.4	6R8
BMMA00050520100MV1	10	20	100	199(184)	4	2.3	100

Note: When ordering, please specify tolerance code. Tolerance: M=±20%

- Operating temperature range –55°C ~ 125°C (Including self - temperature rise)
- Isat for Inductance drop 20% from its value without current
- I rms for a 40°C temperature rise from 25°C ambient with current
- Withstand voltage: 25V DC
- Measure Equipment :
 L : WK 3260B or WK 6500P, 100kHz 0.25V
 RDC : CHEN HWA 502 or CHEN HWA 46502B
 I rms : CHROMA 1810

Test Instruments : WK3260B Impedance / Material Analyzer

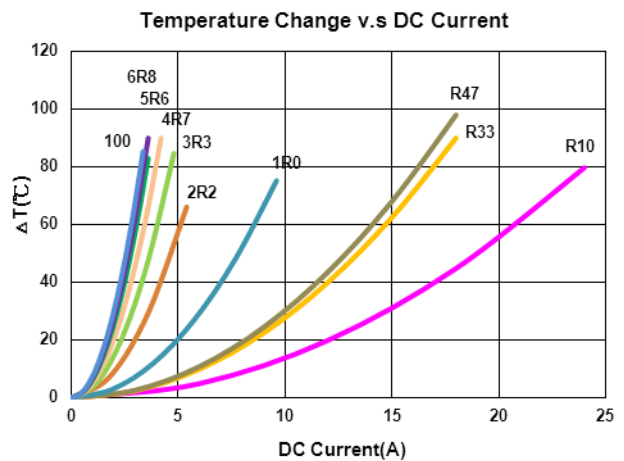
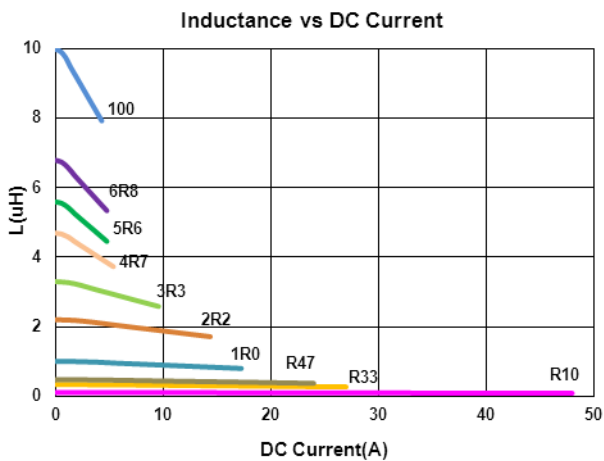

Molding Power Inductors – BMMA Series

Electrical Characteristics

Part Number	Inductance (uH)	Tolerance (±%)	Test Frequency (kHz)	RDC(mΩ) Max(Typ.)	Isat (A)Typ.	Irms (A)Typ.	Marking
BMMA00050530R68MX1	0.68	20	100	12(11)	14	8.5	R68
BMMA000505301R0MX1	1.0	20	100	14(13)	11	7	1R0
BMMA000505301R2MX1	1.2	20	100	16(15)	10.5	6.5	1R2
BMMA000505301R5MX1	1.5	20	100	25(20)	10	6	1R5
BMMA000505302R2MX1	2.2	20	100	35(29)	9	5.5	2R2
BMMA000505303R3MX1	3.3	20	100	38(32)	7	5	3R3

Note: When ordering, please specify tolerance code. Tolerance: M=±20%

- Operating temperature range—55°C ~ 125°C (Including self - temperature rise)
- Isat for Inductance drop 20% from its value without current
- I rms for a 40°C temperature rise from 25°C ambient with current
- Withstand voltage: 25V DC
- Measure Equipment :
 L : WK 3260B or WK 6500P, 100kHz 0.25V
 RDC : CHEN HWA 502 or CHEN HWA 46502B
 I rms : CHROMA 1810

Test Instruments : WK3260B Impedance / Material Analyzer

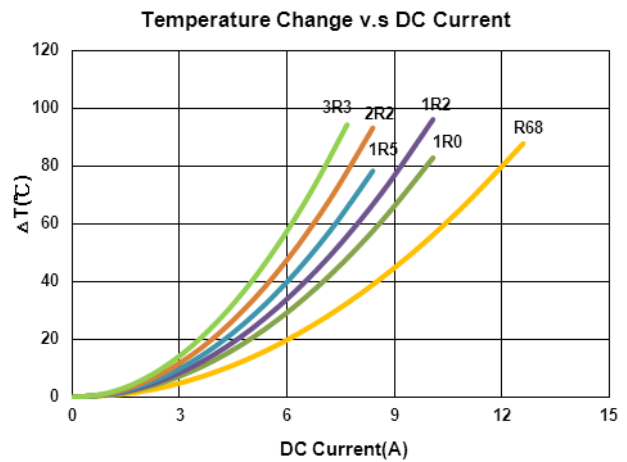
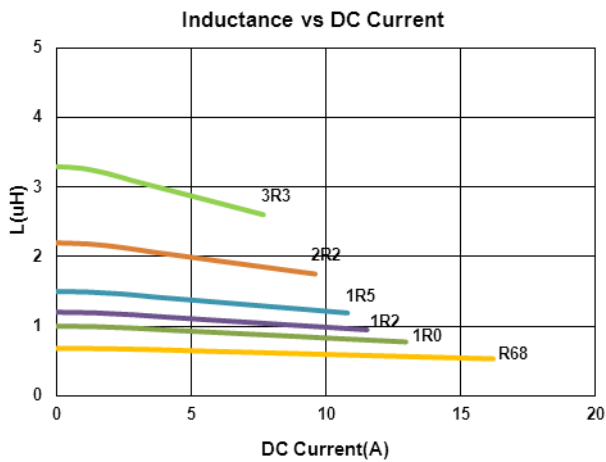

Molding Power Inductors – BMMA Series

Electrical Characteristics

Part Number	Inductance (uH)	Tolerance (±%)	Test Frequency (kHz)	RDC(mΩ) Max(Typ.)	Isat (A)Typ.	Irms (A)Typ.	Marking
BMMA00050530R22MX2	0.22	20	100	3.9(3.5)	14.5	21	R22
BMMA00050530R35MX2	0.35	20	100	5(4.5)	9	16.5	R35
BMMA00050530R47MX2	0.47	20	100	8.5(7.4)	12	13	R47
BMMA00050530R68MX2	0.68	20	100	12(11)	14	8.5	R68
BMMA000505301R0MX2	1.0	20	100	14(13)	11	7	1R0
BMMA000505301R2MX2	1.2	20	100	16(15)	11	6.5	1R2
BMMA000505301R5MX2	1.5	20	100	25(20)	10	6	1R5
BMMA000505302R2MX2	2.2	20	100	35(29)	9	5.5	2R2
BMMA000505303R3MX2	3.3	20	100	38(34)	7	5	3R3

Note: When ordering, please specify tolerance code. Tolerance: M=±20%

- Operating temperature range – 55°C ~ 125°C (Including self - temperature rise)
- Isat for Inductance drop 30% from its value without current
- I rms for a 40°C temperature rise from 25°C ambient with current
- Withstand voltage: 25V DC
- Measure Equipment :
 L : WK 3260B or WK 6500P, 100kHz 0.25V
 RDC : CHEN HWA 502 or CHEN HWA 46502B
 I rms : CHROMA 1810

Test Instruments : WK3260B Impedance / Material Analyzer

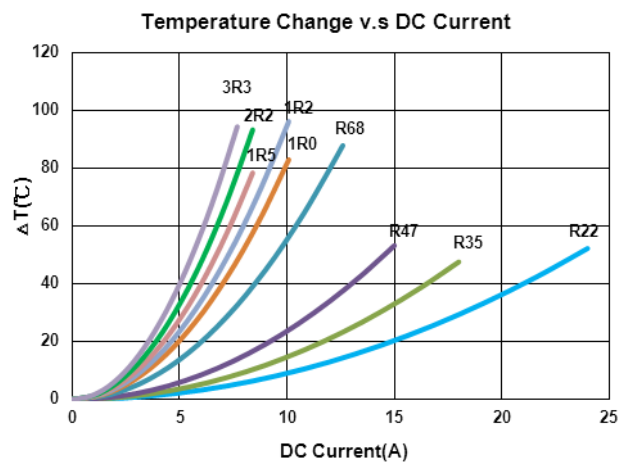
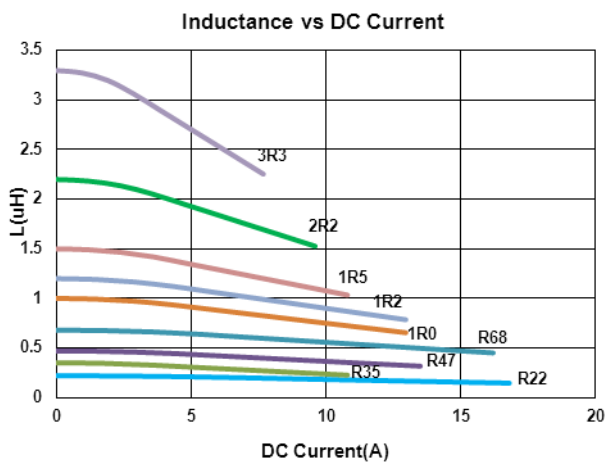

Please be sure to request approval specifications that provide further details of the products. Kindly note that the content of these specifications are subject to change or may be discontinued without prior notice. This product may not be designed/used in medical or high risk applications without Chilisin approval. Please contact our sales department before ordering.

Molding Power Inductors – BMMA Series

Electrical Characteristics

Part Number	Inductance (uH)	Tolerance (±%)	Test Frequency (kHz)	RDC(mΩ) Max(Typ.)	Isat (A)Typ.	Irms (A)Typ.	Marking
BMMA00050530R10MV1	0.10	20	100	3.16(3)	27	23	R10
BMMA00050530R22MV1	0.22	20	100	4.52(4.3)	21	15.5	R22
BMMA00050530R33MV1	0.33	20	100	5.56(5.3)	19	13.7	R33
BMMA00050530R47MV1	0.47	20	100	7.04(6.7)	16	12.2	R47
BMMA00050530R68MV1	0.68	20	100	8.96(8.53)	13.5	10.2	R68
BMMA00050530R82MV1	0.82	20	100	11.9(11.3)	13	9.3	R82
BMMA000505301R0MV1	1.0	20	100	13.7(13.1)	12	9.2	1R0
BMMA000505301R5MV1	1.5	20	100	20.7(19.7)	11	7.2	1R5
BMMA000505302R2MV1	2.2	20	100	29.2(27.8)	10	5.8	2R2
BMMA000505303R3MV1	3.3	20	100	54.7(52.1)	8.5	5	3R3
BMMA000505304R7MV1	4.7	20	100	77.5(73.8)	8.2	3.5	4R7
BMMA000505305R6MV1	5.6	20	100	108(103)	4.1	3	5R6
BMMA00050530100MV1	10	20	100	158(152)	4	2.5	100
BMMA00050530150MV1	15	20	100	265(252)	2.5	1.9	150

Note: When ordering, please specify tolerance code. Tolerance: M=±20%

- Operating temperature range – 55°C ~ 125°C (Including self - temperature rise)
- Isat for Inductance drop 20% from its value without current
- I rms for a 40°C temperature rise from 25°C ambient with current
- Withstand voltage: 25V DC
- Measure Equipment :
 L : WK 3260B or WK 6500P, 100kHz 0.25V
 RDC : CHEN HWA 502 or CHEN HWA 46502B
 I rms : CHROMA 1810

Test Instruments : WK3260B Impedance / Material Analyzer

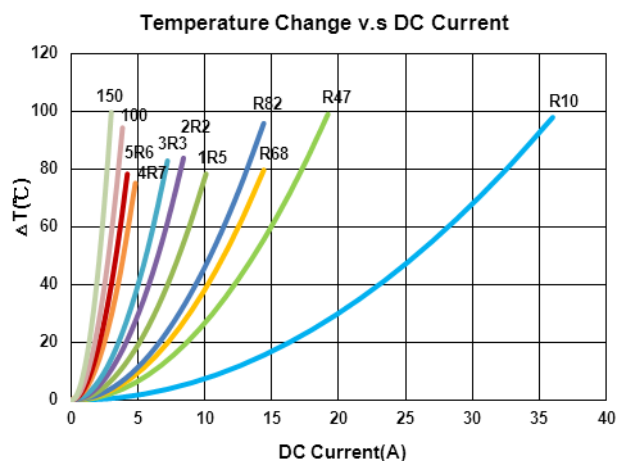
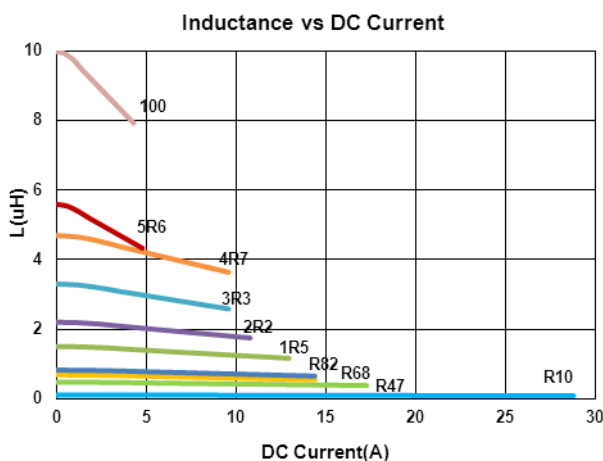

Please be sure to request approval specifications that provide further details of the products. Kindly note that the content of these specifications are subject to change or may be discontinued without prior notice. This product may not be designed/used in medical or high risk applications without Chilisin approval. Please contact our sales department before ordering.

Molding Power Inductors – BMMA Series

Electrical Characteristics

Part Number	Inductance (uH)	Tolerance (±%)	Test Frequency (kHz)	RDC(mΩ) Max(Typ.)	Isat (A)Typ.	Irms (A)Typ.	Marking
BMMA00060618R10MX2	0.10	20	100	2.5(2)	45	18	R10
BMMA00060618R22MX2	0.22	20	100	5.2(4.5)	29	14	R22
BMMA00060618R33MX2	0.33	20	100	6.8(5.2)	22	12	R33
BMMA00060618R47MX2	0.47	20	100	8.4(7.3)	18	11	R47
BMMA00060618R68MX2	0.68	20	100	12.7(10.8)	17	9	R68
BMMA000606181R0MX2	1.0	20	100	17(14.5)	14	7	1R0
BMMA000606181R5MX2	1.5	20	100	26(20)	12	6.5	1R5
BMMA000606182R0MX2	2.0	20	100	32(28)	11	6	2R0
BMMA000606182R2MX2	2.2	20	100	35(31)	13	6	2R2
BMMA000606183R3MX2	3.3	20	100	60(56)	10	3.5	3R3
BMMA000606186R8MX2	6.8	20	100	110(101)	3.5	2.8	6R8

Note: When ordering, please specify tolerance code. Tolerance: M=±20%

- Operating temperature range –55°C ~ 125°C (Including self - temperature rise)
- Isat for Inductance drop 30% from its value without current
- Irms for a 40°C temperature rise from 25°C ambient with current
- Withstand voltage: 25V DC
- Measure Equipment :
 L : WK 3260B or WK 6500P, 100kHz 0.25V
 RDC : CHEN HWA 502 or CHEN HWA 46502B
 Irms : CHROMA 1810

Test Instruments : WK3260B Impedance / Material Analyzer

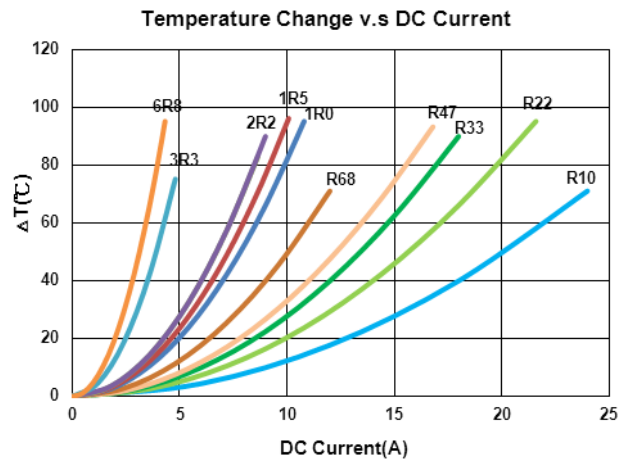
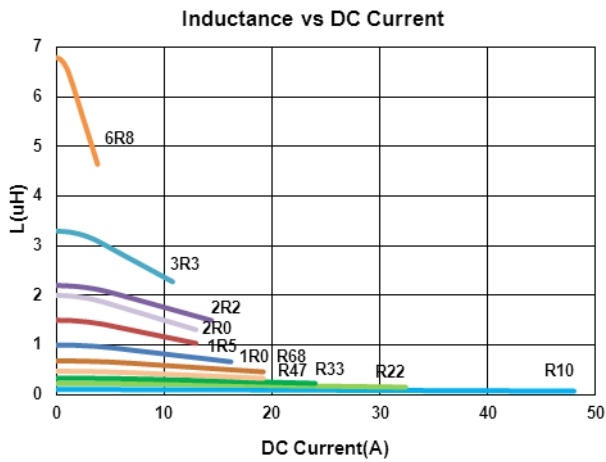

Molding Power Inductors – BMMA Series

Electrical Characteristics

Part Number	Inductance (uH)	Tolerance (±%)	Test Frequency (kHz)	RDC(mΩ) Max(Typ.)	Isat (A)Typ.	Irms (A)Typ.	Marking
BMMA00060618R10MV1	0.10	20	100	3.5(3)	40	18	R10
BMMA00060618R15MV1	0.15	20	100	5.2(4.7)	38	15	R15
BMMA00060618R22MV1	0.22	20	100	5.7(5.3)	26	14	R22
BMMA00060618R33MV1	0.33	20	100	7(6.6)	18	12	R33
BMMA00060618R47MV1	0.47	20	100	9.3(8.4)	18	11	R47
BMMA00060618R68MV1	0.68	20	100	13.9(12.7)	17	9	R68
BMMA00060618R82MV1	0.82	20	100	15.9(13.8)	17	8	R82
BMMA000606181R0MV1	1.0	20	100	18.3(17.5)	14	7	1R0
BMMA000606181R5MV1	1.5	20	100	34(32.6)	11.5	4	1R5
BMMA000606182R2MV1	2.2	20	100	46(40.3)	13	3.75	2R2
BMMA000606182R5MV1	2.5	20	100	52.4(49.9)	10.4	3.5	2R5
BMMA000606183R3MV1	3.3	20	100	60.1(56.2)	10	3.25	3R3
BMMA000606184R7MV1	4.7	20	100	78(76.6)	8	3	4R7

Note: When ordering, please specify tolerance code. Tolerance: M=±20%

- Operating temperature range – 55°C ~ 125°C (Including self - temperature rise)
- Isat for Inductance drop 20% from its value without current
- Iirms for a 40°C temperature rise from 25°C ambient with current
- Withstand voltage: 25V DC
- Measure Equipment :
 L : WK 3260B or WK 6500P, 100kHz 0.25V
 RDC : CHEN HWA 502 or CHEN HWA 46502B
 Iirms : CHROMA 1810

Test Instruments : WK3260B Impedance / Material Analyzer

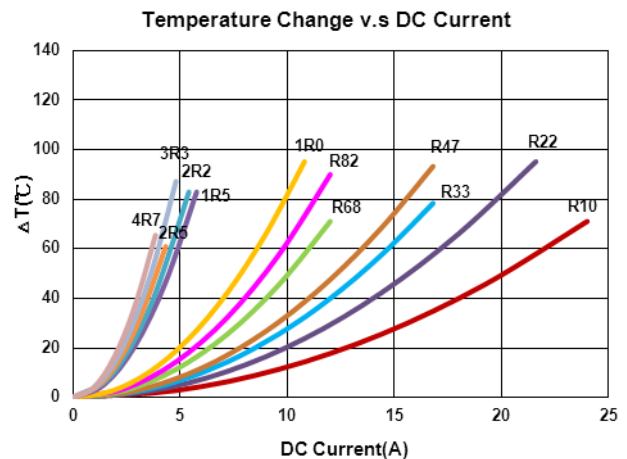
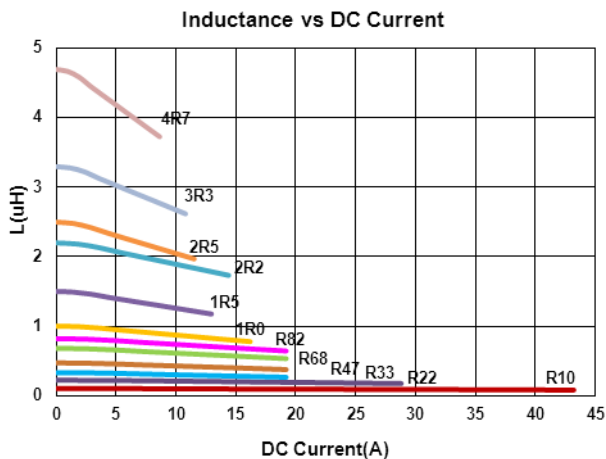

Please be sure to request approval specifications that provide further details of the products. Kindly note that the content of these specifications are subject to change or may be discontinued without prior notice. This product may not be designed/used in medical or high risk applications without Chilisin approval. Please contact our sales department before ordering.

Molding Power Inductors – BMMA Series

Electrical Characteristics

Part Number	Inductance (uH)	Tolerance (±%)	Test Frequency (kHz)	RDC(mΩ) Max(Typ.)	Isat (A)Typ.	Irms (A)Typ.	Marking
BMMA00060624R10MX2	0.10	20	100	1.7(1.5)	70	30	R10
BMMA00060624R20MX2	0.20	20	100	2.8(2.2)	50	25	R20
BMMA00060624R33MX2	0.33	20	100	4.1(3.5)	24.5	18	R33
BMMA00060624R47MX2	0.47	20	100	5.1(4.5)	22	15	R47
BMMA000606241R0MX2	1.0	20	100	13.5(11.2)	16	9	1R0
BMMA000606241R5MX2	1.5	20	100	20(17)	15	9	1R5
BMMA000606242R2MX2	2.2	20	100	28(23)	14	7	2R2
BMMA000606243R3MX2	3.3	20	100	39(31)	13	5.5	3R3
BMMA000606244R7MX2	4.7	20	100	50(41)	10	5	4R7
BMMA000606246R8MX2	6.8	20	100	70(57)	6	4	6R8

Note: When ordering, please specify tolerance code. Tolerance: M=±20%

- Operating temperature range –55°C ~ 125°C (Including self - temperature rise)
- Isat for Inductance drop 30% from its value without current
- I rms for a 40°C temperature rise from 25°C ambient with current
- Withstand voltage: 25V DC
- Measure Equipment :
 - L : WK 3260B or WK 6500P, 100kHz 0.25V
 - RDC : CHEN HWA 502 or CHEN HWA 46502B
 - I rms : CHROMA 1810

Test Instruments : WK3260B Impedance / Material Analyzer

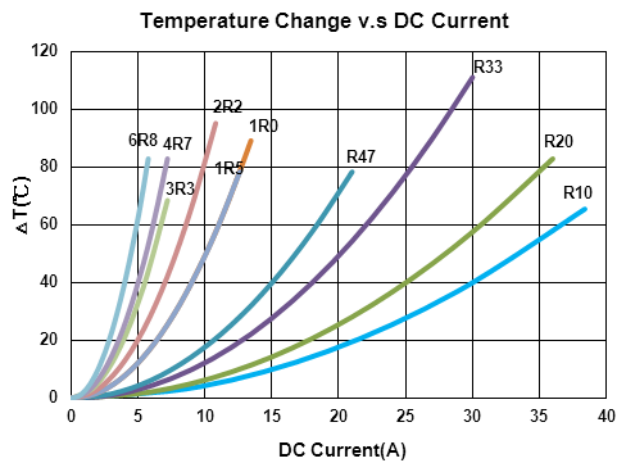
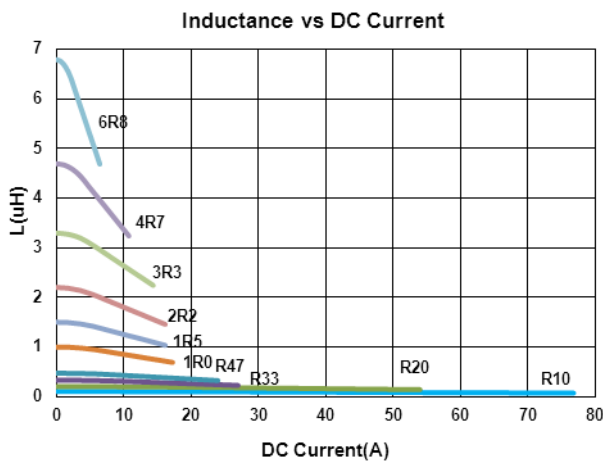

Please be sure to request approval specifications that provide further details of the products. Kindly note that the content of these specifications are subject to change or may be discontinued without prior notice. This product may not be designed/used in medical or high risk applications without Chilisin approval. Please contact our sales department before ordering.

Molding Power Inductors – BMMA Series

Electrical Characteristics

Part Number	Inductance (uH)	Tolerance (±%)	Test Frequency (kHz)	RDC(mΩ) Max(Typ.)	Isat (A)Typ.	Irms (A)Typ.	Marking
BMMA00060624R10MV1	0.10	20	100	1.7(1.5)	50	30	R10
BMMA00060624R22MV1	0.22	20	100	3.2(2.9)	34	21	R22
BMMA00060624R33MV1	0.33	20	100	4.1(3.7)	22	18	R33
BMMA00060624R47MV1	0.47	20	100	6.5(6)	21	13.5	R47
BMMA00060624R68MV1	0.68	20	100	9.4(8.7)	18	11	R68
BMMA00060624R82MV1	0.82	20	100	11.8(10.6)	17	10	R82
BMMA000606241R0MV1	1.0	20	100	14.2(13.1)	16	9	1R0
BMMA000606241R5MV1	1.5	20	100	21.2(18.5)	15	7.5	1R5
BMMA000606242R2MV1	2.2	20	100	34(28)	14	6.5	2R2
BMMA000606243R3MV1	3.3	20	100	51.6(36.5)	13	5	3R3
BMMA000606244R7MV1	4.7	20	100	63(45.2)	10	4.5	4R7
BMMA000606246R8MV1	6.8	20	100	95(72.5)	9	3.5	6R8
BMMA000606248R2MV1	8.2	20	100	106(84.2)	8	3	8R2
BMMA00060624100MV1	10	20	100	105(102)	7	3	100

Note: When ordering, please specify tolerance code. Tolerance: M=±20%

- Operating temperature range – 55°C ~ 125°C (Including self - temperature rise)
- Isat for Inductance drop 20% from its value without current
- I rms for a 40°C temperature rise from 25°C ambient with current
- Withstand voltage: 25V DC
- Measure Equipment :
 L : WK 3260B or WK 6500P, 100kHz 0.25V
 RDC : CHEN HWA 502 or CHEN HWA 46502B
 I rms : CHROMA 1810

Test Instruments : WK3260B Impedance / Material Analyzer

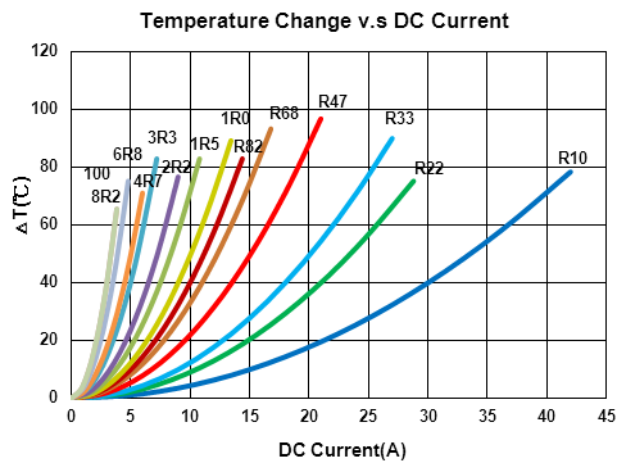
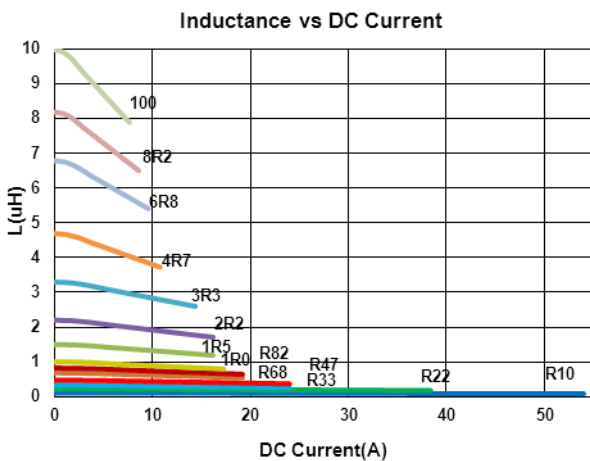

Please be sure to request approval specifications that provide further details of the products. Kindly note that the content of these specifications are subject to change or may be discontinued without prior notice. This product may not be designed/used in medical or high risk applications without Chilisin approval. Please contact our sales department before ordering.

Molding Power Inductors – BMMA Series

Electrical Characteristics

Part Number	Inductance (uH)	Tolerance (±%)	Test Frequency (kHz)	RDC(mΩ) Max(Typ.)	Isat (A)Typ.	Irms (A)Typ.	Marking
BMMA00060630R10MX1	0.10	20	100	1.7(1.5)	60	32.5	R10
BMMA00060630R22MX1	0.22	20	100	2.8(2.5)	40	23	R22
BMMA00060630R33MX1	0.33	20	100	3.9(3.5)	30	20	R33
BMMA00060630R47MX1	0.47	20	100	4.2(4)	26	17.5	R47
BMMA00060630R56MX1	0.56	20	100	5(4.7)	25.5	16.5	R56
BMMA00060630R68MX1	0.68	20	100	5.5(5)	25	15.5	R68
BMMA000606301R0MX1	1.0	20	100	10(9)	22	11	1R0
BMMA000606301R2MX1	1.2	20	100	12(10)	20	10	1R2
BMMA000606301R5MX1	1.5	20	100	15(14)	18	9	1R5
BMMA000606302R2MX1	2.2	20	100	20(18)	14	8	2R2
BMMA000606303R3MX1	3.3	20	100	30(28)	13.5	6	3R3
BMMA000606304R7MX1	4.7	20	100	40(37)	10	5.5	4R7
BMMA000606306R8MX1	6.8	20	100	60(54)	8	4.5	6R8

Note: When ordering, please specify tolerance code. Tolerance: M=±20%

- Operating temperature range – 55°C ~ 125°C (Including self - temperature rise)
- Isat for Inductance drop 20% from its value without current
- I rms for a 40°C temperature rise from 25°C ambient with current
- Withstand voltage: 25V DC.
- Measure Equipment :
 L : WK 3260B or WK 6500P, 100kHz 0.25V
 RDC : CHEN HWA 502 or CHEN HWA 46502B
 I rms : CHROMA 1810

Test Instruments : WK3260B Impedance / Material Analyzer

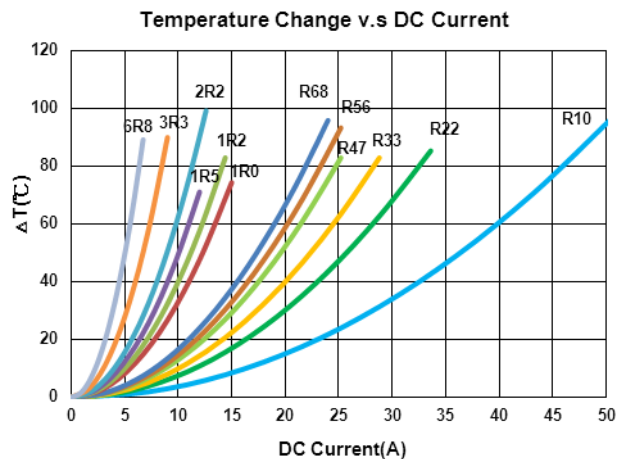
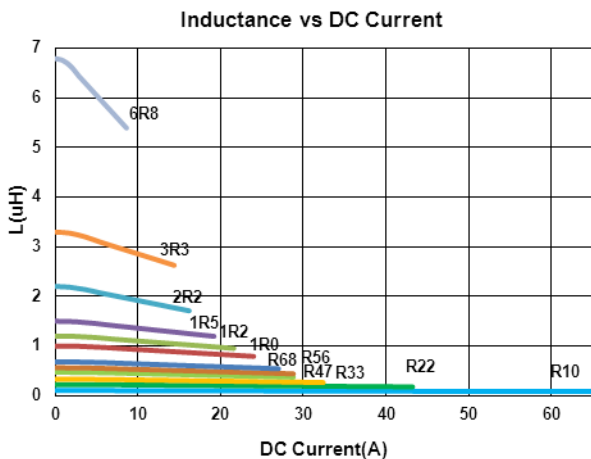

Please be sure to request approval specifications that provide further details of the products. Kindly note that the content of these specifications are subject to change or may be discontinued without prior notice. This product may not be designed/used in medical or high risk applications without Chilisin approval. Please contact our sales department before ordering.

Molding Power Inductors – BMMA Series

Electrical Characteristics

Part Number	Inductance (uH)	Tolerance (±%)	Test Frequency (kHz)	RDC(mΩ) Max(Typ.)	Isat (A)Typ.	Irms (A)Typ.	Marking
BMMA00060630R10MX2	0.10	20	100	1.7(1.5)	60	32.5	R10
BMMA00060630R15MX2	0.15	20	100	2.5(1.9)	45	30	R15
BMMA00060630R20MX2	0.20	20	100	3(2.4)	41	24	R20
BMMA00060630R22MX2	0.22	20	100	2.8(2.5)	40	23	R22
BMMA00060630R33MX2	0.33	20	100	3.5(3)	25	21	R33
BMMA00060630R36MX2	0.36	20	100	3.9(3.3)	26	20	R36
BMMA00060630R47MX2	0.47	20	100	4.1(3.5)	20	18	R47
BMMA00060630R56MX2	0.56	20	100	4.5(3.9)	18	16.5	R56
BMMA00060630R68MX2	0.68	20	100	5(4.5)	17	16	R68
BMMA00060630R82MX2	0.82	20	100	7.5(7)	16	14	R82
BMMA00060630R1R5MX2	1.5	20	100	12.1(10.6)	14	10	1R5
BMMA00060630R3R3MX2	3.3	20	100	28(25)	10	6.5	3R3
BMMA00060630R4R7MX2	4.7	20	100	35(32.5)	6.5	5.5	4R7
BMMA00060630R5R6MX2	5.6	20	100	42(39)	6	5.5	5R6
BMMA00060630R6R8MX2	6.8	20	100	60(54)	8	4.5	6R8
BMMA00060630R8R2MX2	8.2	20	100	60(54)	6	4.5	8R2
BMMA00060630R100MX2	10	20	100	68(62)	5.5	4	100

Note: When ordering, please specify tolerance code. Tolerance: M=±20%

- Operating temperature range – 55°C ~ 125°C (Including self - temperature rise)
- Isat for Inductance drop 30% from its value without current
- I rms for a 40°C temperature rise from 25°C ambient with current
- Withstand voltage: 25V DC
- Measure Equipment :
 L : WK 3260B or WK 6500P, 100kHz 0.25V
 RDC : CHEN HWA 502 or CHEN HWA 46502B
 I rms : CHROMA 1810

Test Instruments : WK3260B Impedance / Material Analyzer

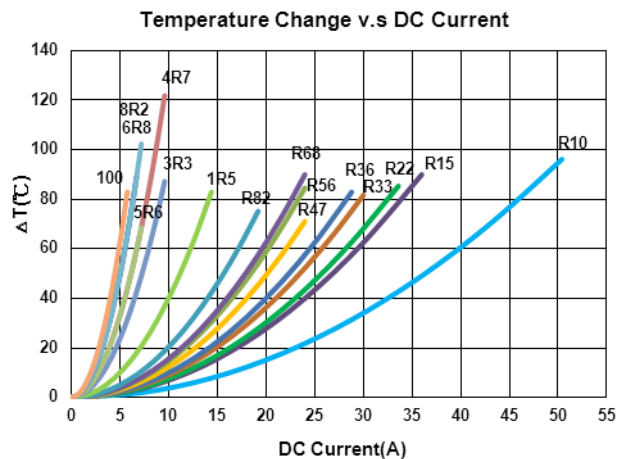
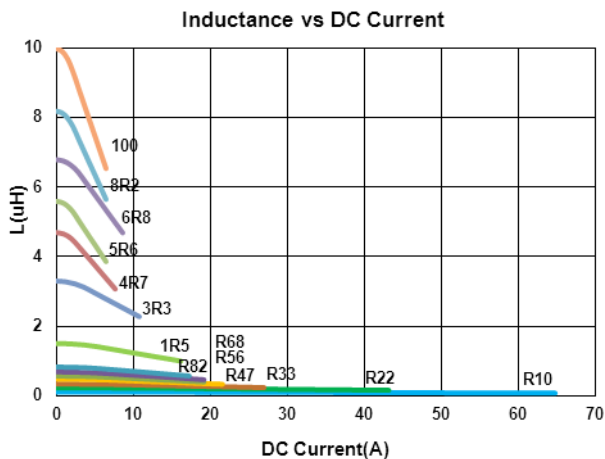

Please be sure to request approval specifications that provide further details of the products. Kindly note that the content of these specifications are subject to change or may be discontinued without prior notice. This product may not be designed/used in medical or high risk applications without Chilisin approval. Please contact our sales department before ordering.

Molding Power Inductors – BMMA Series

Electrical Characteristics

Part Number	Inductance (uH)	Tolerance (±%)	Test Frequency (kHz)	RDC(mΩ) Max(Typ.)	Isat (A)Typ.	Irms (A)Typ.	Marking
BMMA00060630R10MV1	0.10	20	100	1.7(1.5)	60	32.5	R10
BMMA00060630R15MV1	0.15	20	100	2.5(1.9)	52	26	R15
BMMA00060630R20MV1	0.20	20	100	3(2.4)	41	24	R20
BMMA00060630R22MV1	0.22	20	100	2.8(2.5)	40	23	R22
BMMA00060630R33MV1	0.33	20	100	3.9(3.5)	30	20	R33
BMMA00060630R47MV1	0.47	20	100	4.2(4)	26	17.5	R47
BMMA00060630R68MV1	0.68	20	100	5.5(5)	25	15.5	R68
BMMA00060630R82MV1	0.82	20	100	8(6.7)	24	13	R82
BMMA000606301R0MV1	1.0	20	100	10(9)	22	11	1R0
BMMA000606301R5MV1	1.5	20	100	15(14)	18	9	1R5
BMMA000606302R2MV1	2.2	20	100	20(18)	14	8	2R2
BMMA000606303R3MV1	3.3	20	100	30(28)	13.5	6	3R3
BMMA000606304R7MV1	4.7	20	100	40(37)	10	5.5	4R7
BMMA000606306R8MV1	6.8	20	100	60(54)	8	4.5	6R8
BMMA000606308R2MV1	8.2	20	100	68(64)	7.5	4	8R2
BMMA00060630100MV1	10	20	100	105(102)	7	3	100

Note: When ordering, please specify tolerance code. Tolerance: M=±20%

- Operating temperature range – 55°C ~ 125°C (Including self - temperature rise)
- Isat for Inductance drop 20% from its value without current
- Irms for a 40°C temperature rise from 25°C ambient with current
- Withstand voltage: 25V DC.
- Measure Equipment :
 L : WK 3260B or WK 6500P, 100kHz 0.25V
 RDC : CHEN HWA 502 or CHEN HWA 46502B
 Irms : CHROMA 1810

Test Instruments : WK3260B Impedance / Material Analyzer

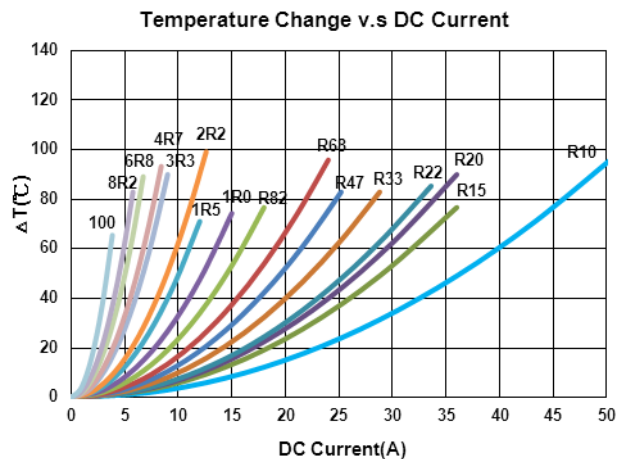
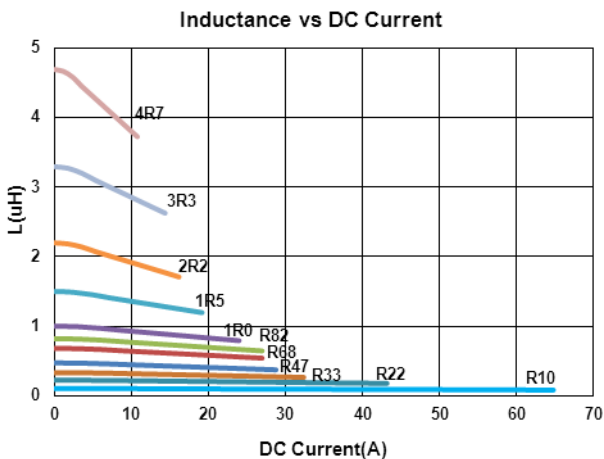

Please be sure to request approval specifications that provide further details of the products. Kindly note that the content of these specifications are subject to change or may be discontinued without prior notice. This product may not be designed/used in medical or high risk applications without Chilisin approval. Please contact our sales department before ordering.

Molding Power Inductors – BMMA Series

Electrical Characteristics

Part Number	Inductance (uH)	Tolerance (±%)	Test Frequency (kHz)	RDC(mΩ) Max(Typ.)	Isat (A)Typ.	Irms(A) (A)Typ.	Marking
BMMA00060640R36MX1	0.36	20	100	2.3(1.8)	32	23	R36

Note: When ordering, please specify tolerance code. Tolerance: M=±20%

- Operating temperature range—55°C ~ 125°C (Including self - temperature rise)
- Isat for Inductance drop 20% from its value without current
- I rms for a 40°C temperature rise from 25°C ambient with current
- Withstand voltage: 25V DC
- Measure Equipment :
 L : WK 3260B or WK 6500P, 100kHz 0.25V
 RDC : CHEN HWA 502 or CHEN HWA 46502B
 I rms : CHROMA 1810

Test Instruments : WK3260B Impedance / Material Analyzer

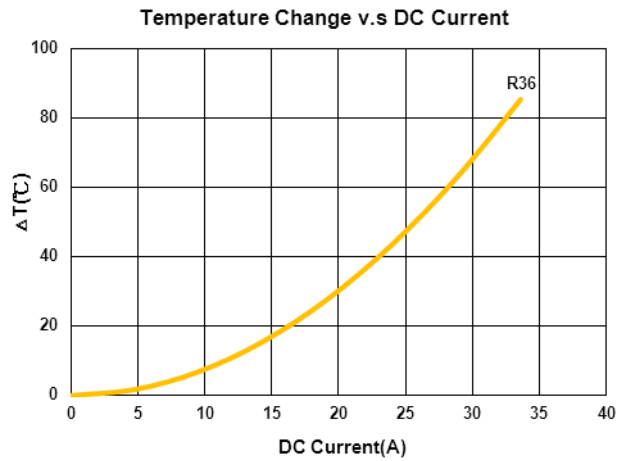
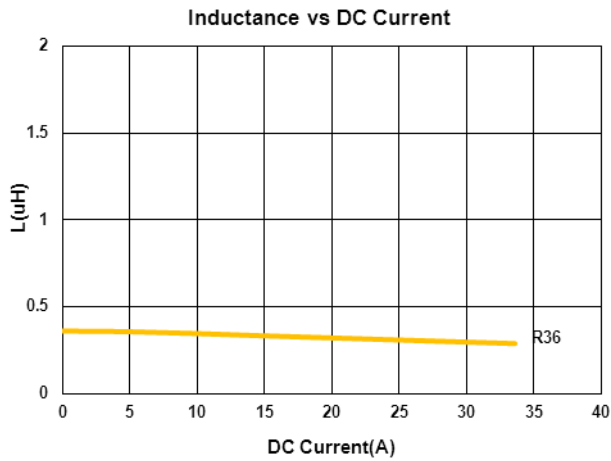

Molding Power Inductors – BMMA Series

Electrical Characteristics

Part Number	Inductance (uH)	Tolerance (±%)	Test Frequency (kHz)	RDC(mΩ) Max(Typ.)	Isat (A)Typ.	Irms(A) (A)Typ.	Marking
BMMA000606403R3MX2	3.3	20	100	23(21)	13	7	3R3

Note: When ordering, please specify tolerance code. Tolerance: M=±20%

- Operating temperature range—55°C ~ 125°C (Including self - temperature rise)
- Isat for Inductance drop 30% from its value without current
- Irms for a 40°C temperature rise from 25°C ambient with current
- Withstand voltage: 25V DC
- Measure Equipment :
 L : WK 3260B or WK 6500P, 100kHz 0.25V
 RDC : CHEN HWA 502 or CHEN HWA 46502B
 Irms : CHROMA 1810

Test Instruments : WK3260B Impedance / Material Analyzer

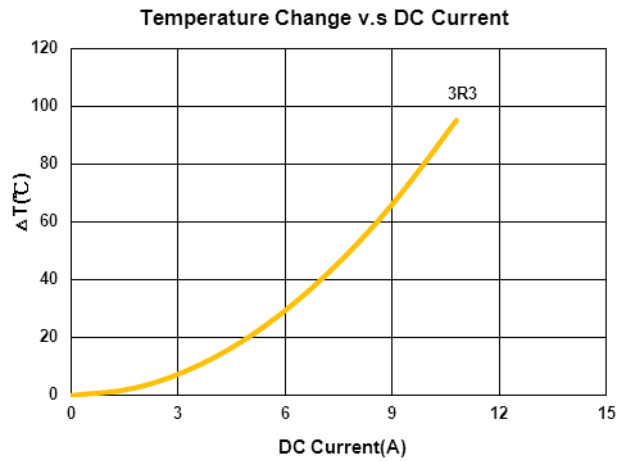
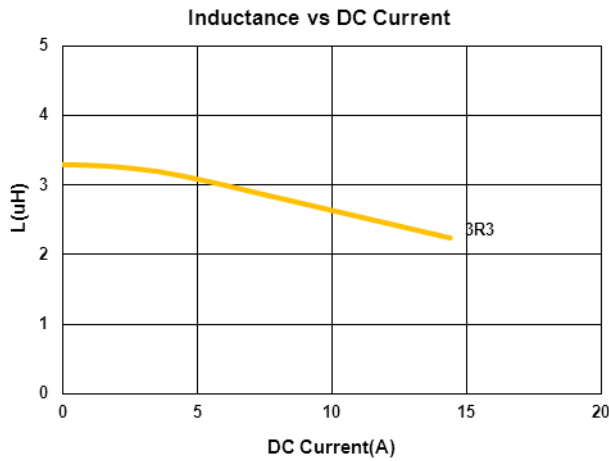

Molding Power Inductors – BMMA Series

Electrical Characteristics

Part Number	Inductance (uH)	Tolerance (±%)	Test Frequency (kHz)	RDC(mΩ) Max(Typ.)	Isat (A)Typ.	Irms(A) (A)Typ.	Marking
BMMA00060650R22MX1	0.22	20	100	1.4(1.2)	50	30	R22
BMMA00060650R47MX1	0.47	20	100	3.9(3.5)	30	20	R47

Note: When ordering, please specify tolerance code. Tolerance: M=±20%

- Operating temperature range –55°C ~ 125°C (Including self - temperature rise)
- Isat for Inductance drop 20% from its value without current
- I rms for a 40°C temperature rise from 25°C ambient with current
- Withstand voltage: 25V DC
- Measure Equipment :
 - L : WK 3260B or WK 6500P, 100kHz 0.25V
 - RDC : CHEN HWA 502 or CHEN HWA 46502B
 - I rms : CHROMA 1810

Test Instruments : WK3260B Impedance / Material Analyzer

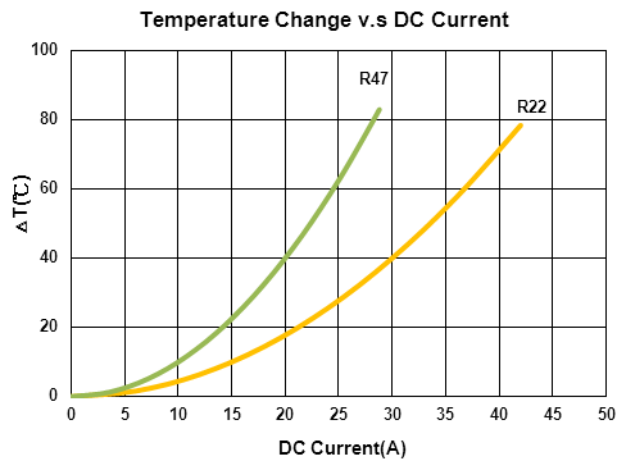
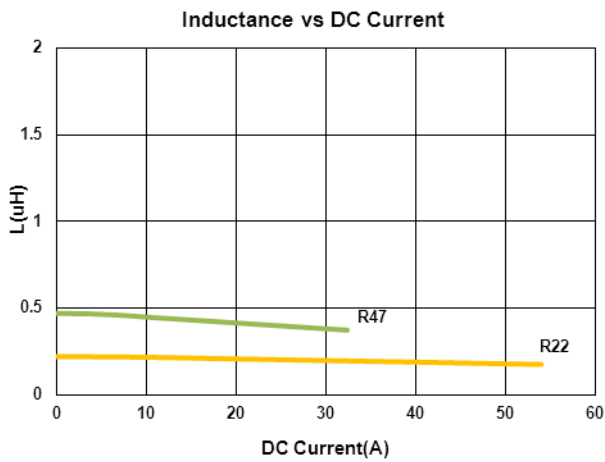

Please be sure to request approval specifications that provide further details of the products. Kindly note that the content of these specifications are subject to change or may be discontinued without prior notice. This product may not be designed/used in medical or high risk applications without Chilisin approval. Please contact our sales department before ordering.

Molding Power Inductors – BMMA Series

Electrical Characteristics

Part Number	Inductance (uH)	Tolerance (±%)	Test Frequency (kHz)	RDC(mΩ) Max(Typ.)	Isat (A)Typ.	Irms (A)Typ.	Marking
BMMA00060650R36MX2	0.36	20	100	3.1(2.7)	25	21	R36
BMMA00060650R68MX2	0.68	20	100	4.2(3.9)	16	18	R68
BMMA000606501R0MX2	1.0	20	100	6.5(5.6)	15	13	1R0
BMMA000606501R5MX2	1.5	20	100	7.5(6.7)	12	11	1R5
BMMA000606502R2MX2	2.2	20	100	12.5(11.2)	12	8	2R2

Note: When ordering, please specify tolerance code. Tolerance: M=±20%

- Operating temperature range – 55°C ~ 125°C (Including self - temperature rise)
- Isat for Inductance drop 30% from its value without current
- I rms for a 40°C temperature rise from 25°C ambient with current
- Withstand voltage: 25V DC.
- Measure Equipment :
 L : WK 3260B or WK 6500P, 100kHz 0.25V
 RDC : CHEN HWA 502 or CHEN HWA 46502B
 I rms : CHROMA 1810

Test Instruments : WK3260B Impedance / Material Analyzer

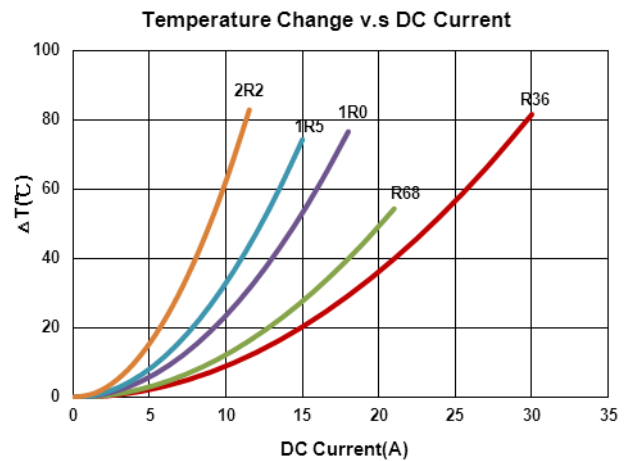
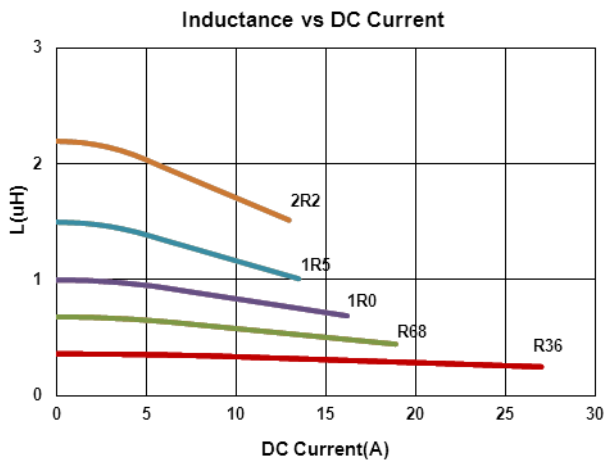

Please be sure to request approval specifications that provide further details of the products. Kindly note that the content of these specifications are subject to change or may be discontinued without prior notice. This product may not be designed/used in medical or high risk applications without Chilisin approval. Please contact our sales department before ordering.

Molding Power Inductors – BMMA Series

Electrical Characteristics

Part Number	Inductance (uH)	Tolerance (±%)	Test Frequency (kHz)	RDC(mΩ) Max(Typ.)	Isat (A)Typ.	Irms (A)Typ.	Marking
BMMA00060650R56MV1	0.56	20	100	3.6(3.4)	12	20	R56
BMMA00060650R68MV1	0.68	20	100	4.5(4.2)	11.5	18	R68
BMMA00060650R82MV1	0.82	20	100	4.9(4.6)	13	16.5	R82
BMMA000606501R0MV1	1.0	20	100	6.5(5.6)	15	13	1R0
BMMA000606501R5MV1	1.5	20	100	9(8.6)	12	12	1R5
BMMA000606502R2MV1	2.2	20	100	13.6(13)	10	10	2R2
BMMA000606503R3MV1	3.3	20	100	20.9(19.9)	8	8	3R3
BMMA000606504R7MV1	4.7	20	100	30.3(28.9)	7	6.5	4R7
BMMA000606505R6MV1	5.6	20	100	34.4(32.7)	7	6	5R6
BMMA000606506R8MV1	6.8	20	100	44.6(42.5)	5.5	5.5	6R8
BMMA000606508R2MV1	8.2	20	100	45.6(43.5)	5.5	5.5	8R2
BMMA00060650100MV1	10	20	100	71.3(67.9)	4.5	4.5	100

Note: When ordering, please specify tolerance code. Tolerance: M=±20%

- Operating temperature range – 55°C ~ 125°C (Including self - temperature rise)
- Isat for Inductance drop 20% from its value without current
- I rms for a 40°C temperature rise from 25°C ambient with current
- Withstand voltage: 25V DC.
- Measure Equipment :
 - L : WK 3260B or WK 6500P, 100kHz 0.25V
 - RDC : CHEN HWA 502 or CHEN HWA 46502B
 - I rms : CHROMA 1810

Test Instruments : WK3260B Impedance / Material Analyzer

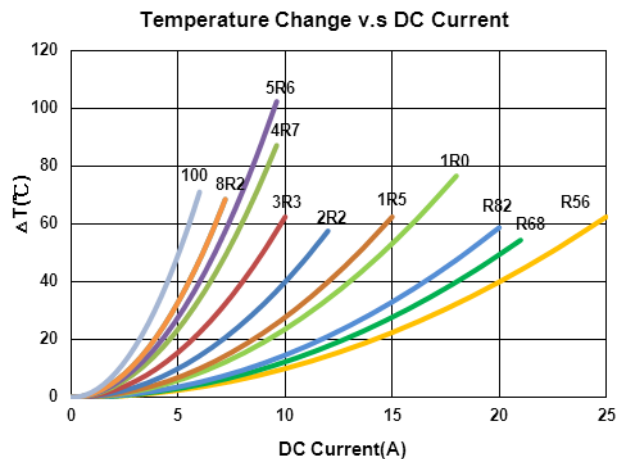
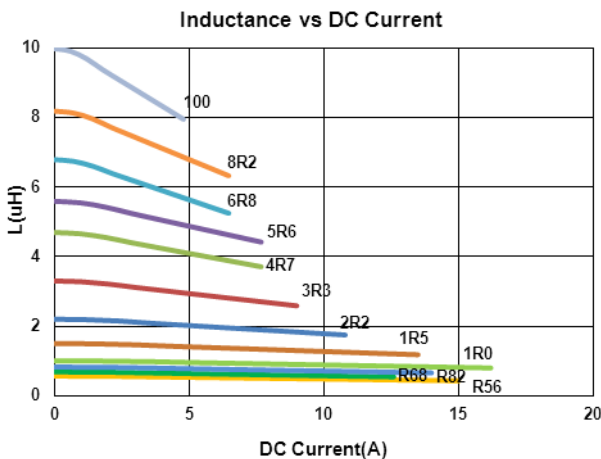

Please be sure to request approval specifications that provide further details of the products. Kindly note that the content of these specifications are subject to change or may be discontinued without prior notice. This product may not be designed/used in medical or high risk applications without Chilisin approval. Please contact our sales department before ordering.

Molding Power Inductors – BMMA Series

Electrical Characteristics

Part Number	Inductance (uH)	Tolerance (±%)	Test Frequency (kHz)	RDC(mΩ) Max(Typ.)	Isat (A)Typ.	Irms (A)Typ.	Marking
BMMA00080830R22MV1	0.22	20	100	1.61(1.5)	43	32	R22
BMMA00080830R47MV1	0.47	20	100	3.33(3.11)	35	21.5	R47
BMMA000808301R0MV1	1.0	20	100	8.35(7.8)	29	13.7	1R0
BMMA000808301R5MV1	1.5	20	100	13.3(12.4)	24	11	1R5
BMMA000808304R7MV1	4.7	20	100	34.2(32)	10.5	6.6	4R7

Note: When ordering, please specify tolerance code. Tolerance: M=±20%

- Operating temperature range – 55°C ~ 125°C (Including self - temperature rise)
- Isat for Inductance drop 20% from its value without current
- I rms for a 40°C temperature rise from 25°C ambient with current
- Withstand voltage: 25V DC
- Measure Equipment :
 L : WK 3260B or WK 6500P, 100kHz 0.25V
 RDC : CHEN HWA 502 or CHEN HWA 46502B
 I rms : CHROMA 1810

Test Instruments : WK3260B Impedance / Material Analyzer

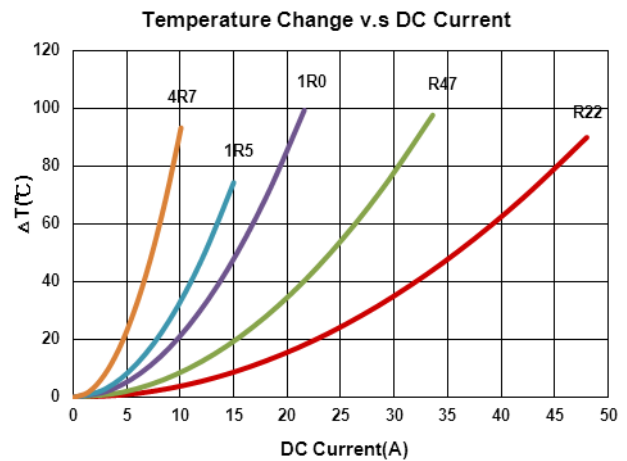
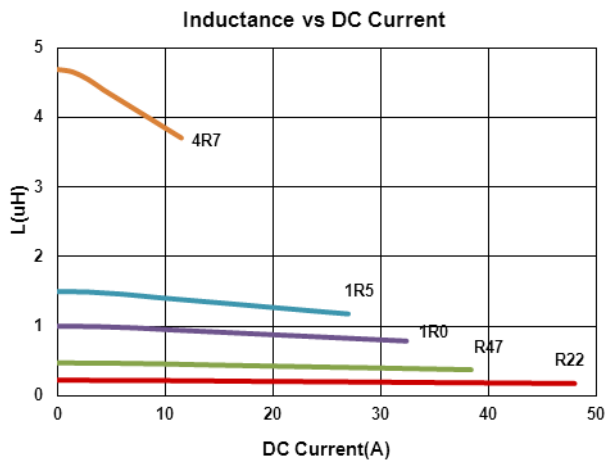

Electrical Characteristics

Part Number	Inductance (uH)	Tolerance (±%)	Test Frequency (kHz)	RDC(mΩ) Max(Typ.)	Isat (A)Typ.	Irms (A)Typ.	Marking
BMMA00080840R22MV1	0.22	20	100	1.68(1.57)	34	30.7	R22
BMMA00080840R47MV1	0.47	20	100	2.62(2.45)	31.5	25	R47
BMMA00080840R68MV1	0.68	20	100	3.67(3.43)	24.5	21	R68
BMMA000808401R0MV1	1.0	20	100	5.78(5.4)	24	18	1R0
BMMA000808402R2MV1	2.2	20	100	13.7(12.8)	23	10.5	2R2
BMMA000808404R7MV1	4.7	20	100	32(29.9)	15	7.25	4R7

Note: When ordering, please specify tolerance code. Tolerance: M=±20%

- Operating temperature range—55°C ~ 125°C (Including self - temperature rise)
- Isat for Inductance drop 20% from its value without current
- Irms for a 40°C temperature rise from 25°C ambient with current
- Withstand voltage: 25V DC
- Measure Equipment :
 L : WK 3260B or WK 6500P, 100kHz 0.25V
 RDC : CHEN HWA 502 or CHEN HWA 46502B
 Irms : CHROMA 1810

Test Instruments : WK3260B Impedance / Material Analyzer

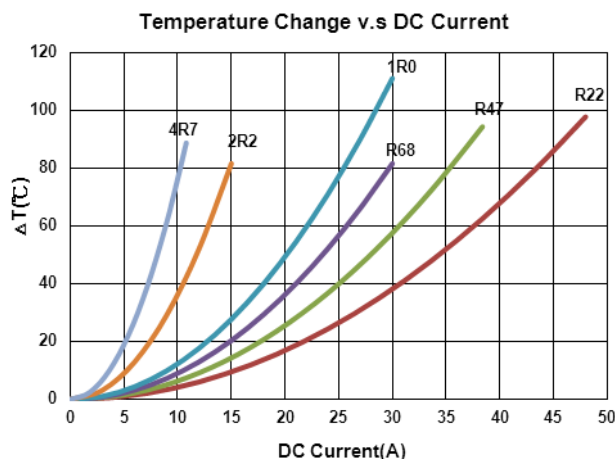
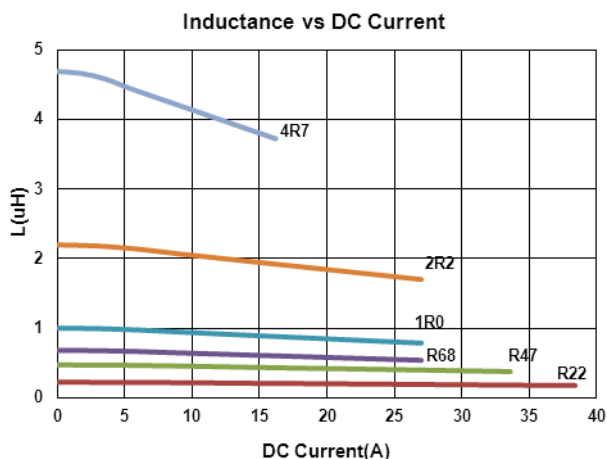

Molding Power Inductors – BMMA Series

Electrical Characteristics

Part Number	Inductance (uH)	Tolerance (±%)	Test Frequency (kHz)	RDC(mΩ) Max(Typ.)	Isat(A) Max(Typ.)	Irms(A) Max(Typ.)	Marking
BMMA001010151R5MX1	1.5	20	100	26(22)	8.5(10)	7(7.8)	1R5
BMMA001010152R2MX1	2.2	20	100	34(28.5)	7(8)	5(6)	2R2

Note: When ordering, please specify tolerance code. Tolerance: M=±20%

- Operating temperature range –55°C ~ 125°C (Including self - temperature rise)
- Isat for Inductance drop 30% from its value without current
- I rms for a 40°C temperature rise from 25°C ambient with current
- Withstand voltage: 25V DC
- Measure Equipment :
 L : WK 3260B or WK 6500P, 100kHz 0.25V
 RDC : CHEN HWA 502 or CHEN HWA 46502B
 I rms : CHROMA 1810

Test Instruments : WK3260B Impedance / Material Analyzer

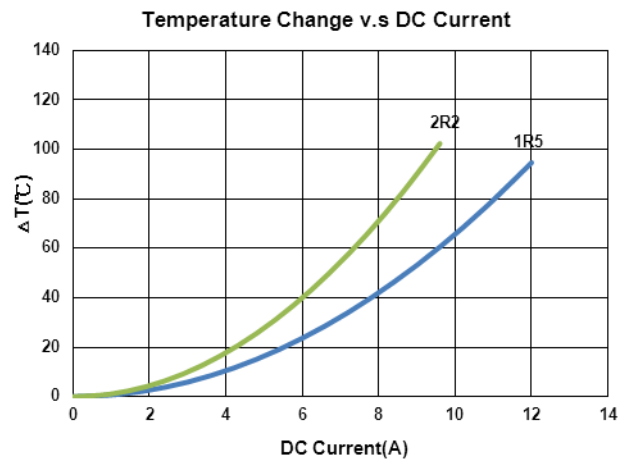
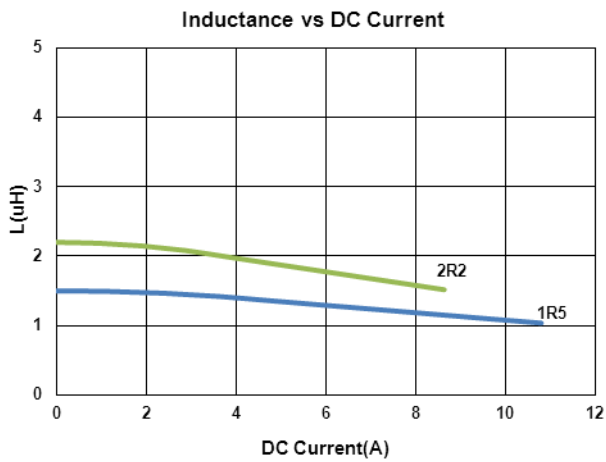

Molding Power Inductors – BMMA Series

Electrical Characteristics

Part Number	Inductance (uH)	Tolerance (±%)	Test Frequency (kHz)	RDC(mΩ) Max(Typ.)	Isat (A)Typ.	Irms (A)Typ.	Marking
BMMA00101030R22MX2	0.22	20	100	1.2(1.07)	50	30	R22
BMMA00101030R36MX2	0.36	20	100	1.15(1.05)	30	26	R36
BMMA00101030R47MX2	0.47	20	100	2.5(2.1)	26	20	R47
BMMA00101030R68MX2	0.68	20	100	3.4(2.9)	23	21	R68
BMMA001010301R0MX2	1.0	20	100	6(5.3)	18	13	1R0
BMMA001010302R2MX2	2.2	20	100	9(8)	16	13	2R2
BMMA001010303R3MX2	3.3	20	100	16(14.5)	14	9	3R3
BMMA001010304R7MX2	4.7	20	100	22.5(20.5)	13	7	4R7
BMMA00101030100MX2	10	20	100	55(50)	7.5	5	100

Note: When ordering, please specify tolerance code. Tolerance: M=±20%

- Operating temperature range – 55°C ~ 125°C (Including self - temperature rise)
- Isat for Inductance drop 30% from its value without current
- I rms for a 40°C temperature rise from 25°C ambient with current
- Withstand voltage: 25V DC
- Measure Equipment :
 L : WK 3260B or WK 6500P, 100kHz 0.25V
 RDC : CHEN HWA 502 or CHEN HWA 46502B
 I rms : CHROMA 1810

Test Instruments : WK3260B Impedance / Material Analyzer

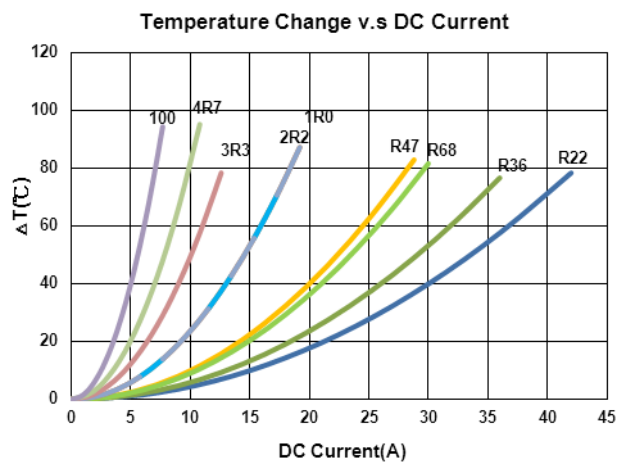
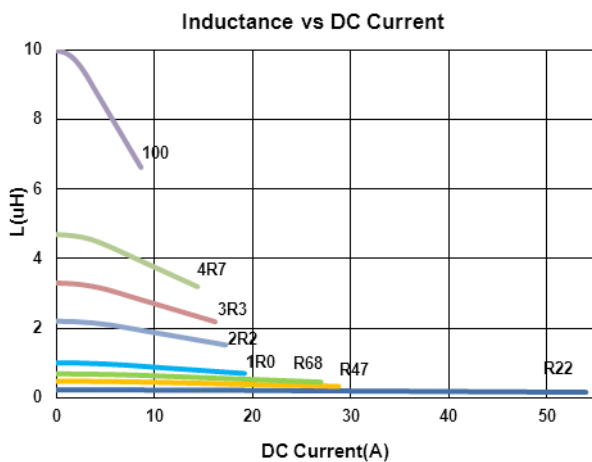

Molding Power Inductors – BMMA Series

Electrical Characteristics

Part Number	Inductance (uH)	Tolerance (±%)	Test Frequency (kHz)	RDC (mΩ)±10%	Isat (A)Typ.	Irms (A)Typ.	Marking
BMMA001010402R2MI8	2.2	20	100	5.5	20	15	2R2

Note: When ordering, please specify tolerance code. Tolerance: M=±20%

- Operating temperature range—55°C ~ 125°C (Including self - temperature rise)
- Isat for Inductance drop 25% from its value without current
- Irms for a 40°C temperature rise from 25°C ambient with current
- Withstand voltage: 25V DC
- Measure Equipment :
 L : WK 3260B or WK 6500P, 100kHz 0.25V
 RDC : CHEN HWA 502 or CHEN HWA 46502B
 Irms : CHROMA 1810

Test Instruments : WK3260B Impedance / Material Analyzer

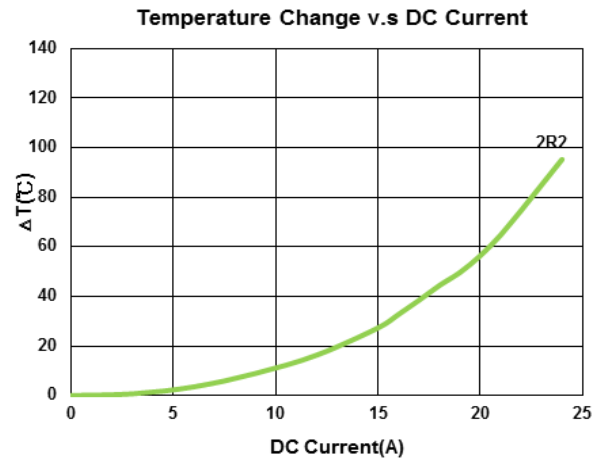
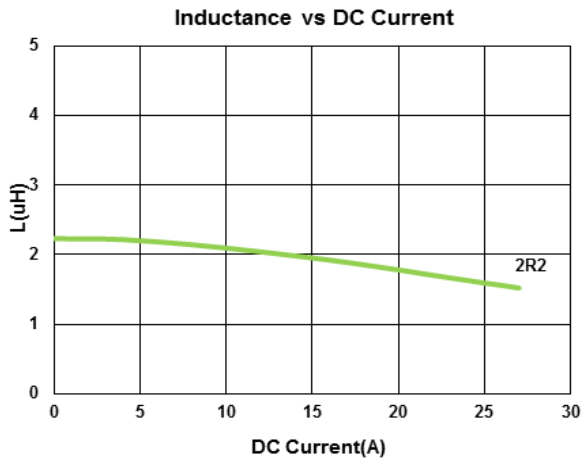

Molding Power Inductors – BMMA Series

Electrical Characteristics

Part Number	Inductance (uH)	Tolerance (±%)	Test Frequency (kHz)	RDC(mΩ) Max(Typ.)	Isat (A)Typ.	Irms (A)Typ.	Marking
BMMA00101040R15MX1	0.15	20	100	0.65(0.5)	75	40	R15
BMMA00101040R36MX1	0.36	20	100	1.2(1.05)	60	30	R36
BMMA00101040R41MX1	0.41	20	100	1.3(1.1)	60	30	R41
BMMA00101040R47MX1	0.47	20	100	1.8(1.6)	40	26	R47
BMMA00101040R56MX1	0.56	20	100	1.8(1.6)	40	25	R56
BMMA00101040R68MX1	0.68	20	100	2.7(2.4)	39	22	R68
BMMA00101040R88MX1	0.88	20	100	3(2.7)	38	20	R88
BMMA001010401R0MX1	1.0	20	100	3.3(2.9)	36	18	1R0
BMMA001010401R5MX1	1.5	20	100	4.2(3.8)	33	16	1R5
BMMA001010402R2MX1	2.2	20	100	7(6.6)	27	12	2R2
BMMA001010404R7MX1	4.7	20	100	16.5(15)	17	9.5	4R7
BMMA00101040100MX1	10	20	100	30(27.5)	6	6	100

Note: When ordering, please specify tolerance code. Tolerance: M=±20%

- Operating temperature range – 55°C ~ 125°C (Including self - temperature rise)
- Isat for Inductance drop 20% from its value without current
- I rms for a 40°C temperature rise from 25°C ambient with current
- Withstand voltage: 25V DC
- Measure Equipment :
 L : WK 3260B or WK 6500P, 100kHz 0.25V
 RDC : CHEN HWA 502 or CHEN HWA 46502B
 I rms : CHROMA 1810

Test Instruments : WK3260B Impedance / Material Analyzer

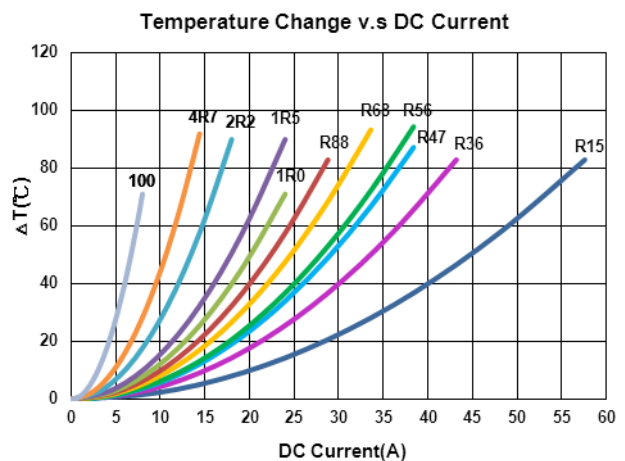
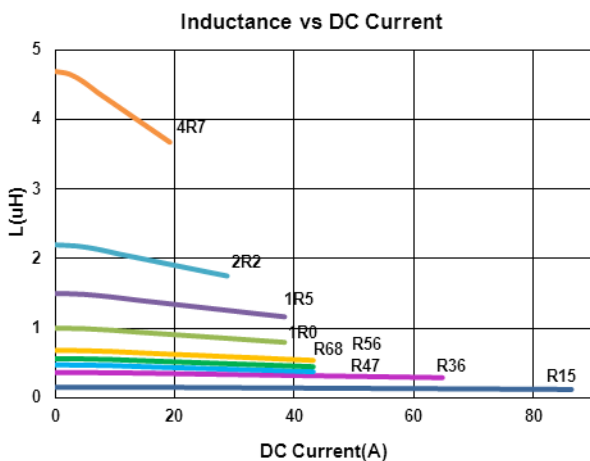

Please be sure to request approval specifications that provide further details of the products. Kindly note that the content of these specifications are subject to change or may be discontinued without prior notice. This product may not be designed/used in medical or high risk applications without Chilisin approval. Please contact our sales department before ordering.

Molding Power Inductors – BMMA Series

Electrical Characteristics

Part Number	Inductance (uH)	Tolerance (±%)	Test Frequency (kHz)	RDC(mΩ) Max(Typ.)	Isat (A)Typ.	Irms (A)Typ.	Marking
BMMA00101040R22MX2	0.22	20	100	1(0.9)	60	35	R22
BMMA00101040R36MX2	0.36	20	100	1.2(1.05)	60	30	R36
BMMA00101040R56MX2	0.56	20	100	1.8(1.6)	33	25	R56
BMMA001010401R0MX2	1.0	20	100	3.3(3)	28	18	1R0
BMMA001010401R5MX2	1.5	20	100	4.2(3.8)	32	16	1R5
BMMA001010401R8MX2	1.8	20	100	5(4.5)	15	15	1R8
BMMA001010403R3MX2	3.3	20	100	11.8(10.8)	16	10	3R3
BMMA001010405R6MX2	5.6	20	100	23(20)	14	8	5R6
BMMA001010406R8MX2	6.8	20	100	25(22.5)	9	6.5	6R8
BMMA00101040100MX2	10	20	100	30(27)	8.5	7.5	100

Note: When ordering, please specify tolerance code. Tolerance: M=±20%

- Operating temperature range –55°C ~ 125°C (Including self - temperature rise)
- Isat for Inductance drop 30% from its value without current
- I rms for a 40°C temperature rise from 25°C ambient with current
- Withstand voltage: 25V DC
- Measure Equipment :
 - L : WK 3260B or WK 6500P, 100kHz 0.25V
 - RDC : CHEN HWA 502 or CHEN HWA 46502B
 - I rms : CHROMA 1810

Test Instruments : WK3260B Impedance / Material Analyzer

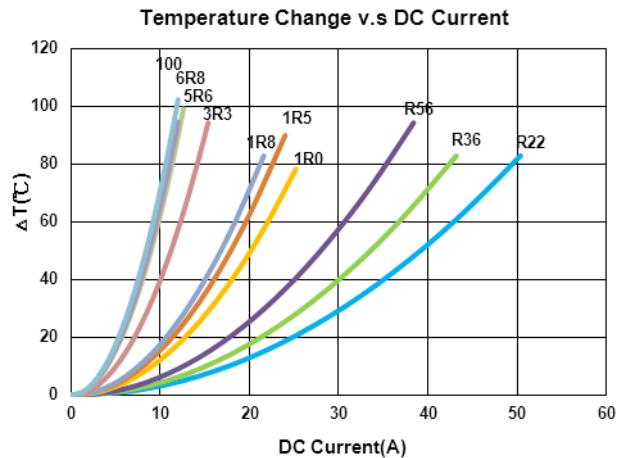
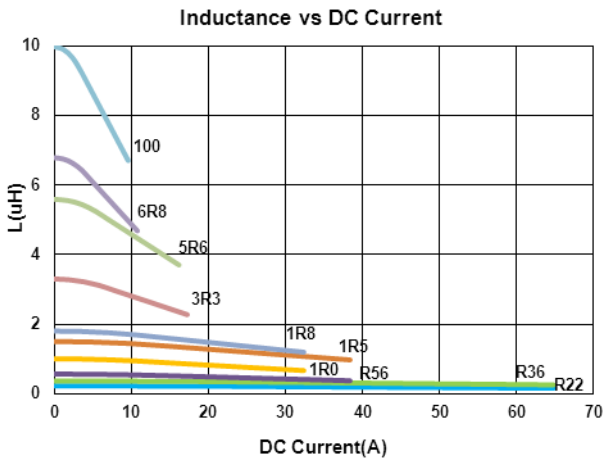

Please be sure to request approval specifications that provide further details of the products. Kindly note that the content of these specifications are subject to change or may be discontinued without prior notice. This product may not be designed/used in medical or high risk applications without Chilisin approval. Please contact our sales department before ordering.

Molding Power Inductors – BMMA Series

Electrical Characteristics

Part Number	Inductance (uH)	Tolerance (±%)	Test Frequency (kHz)	RDC(mΩ) Max(Typ.)	Isat (A)Typ.	Irms (A)Typ.	Marking
BMMA00101040R19MV1	0.19	20	100	0.95(0.87)	90	40	R19
BMMA00101040R36MV1	0.36	20	100	1.4(1.3)	60	31.5	R36
BMMA00101040R56MV1	0.56	20	100	1.8(1.7)	49	27.5	R56
BMMA001010401R0MV1	1.0	20	100	4.1(3.7)	36	17.5	1R0
BMMA001010401R5MV1	1.5	20	100	5.8(5.3)	27.5	15	1R5
BMMA001010402R2MV1	2.2	20	100	9(8.2)	25.6	12	2R2
BMMA001010403R3MV1	3.3	20	100	11.8(10.8)	18.6	10	3R3
BMMA001010404R7MV1	4.7	20	100	16.5(15)	17	9.5	4R7
BMMA001010405R6MV1	5.6	20	100	19.3(17.6)	16	8.5	5R6
BMMA001010406R8MV1	6.8	20	100	23.3(21.2)	13.5	8	6R8
BMMA00101040100MV1	10	20	100	36.5(33.2)	12	6.8	100

Note: When ordering, please specify tolerance code. Tolerance: M=±20%

- Operating temperature range –55°C ~ 125°C (Including self - temperature rise)
- Isat for Inductance drop 20% from its value without current
- Irms for a 40°C temperature rise from 25°C ambient with current
- Withstand voltage: 25V DC
- Measure Equipment :
 L : WK 3260B or WK 6500P, 100kHz 0.25V
 RDC : CHEN HWA 502 or CHEN HWA 46502B
 Irms : CHROMA 1810

Test Instruments : WK3260B Impedance / Material Analyzer

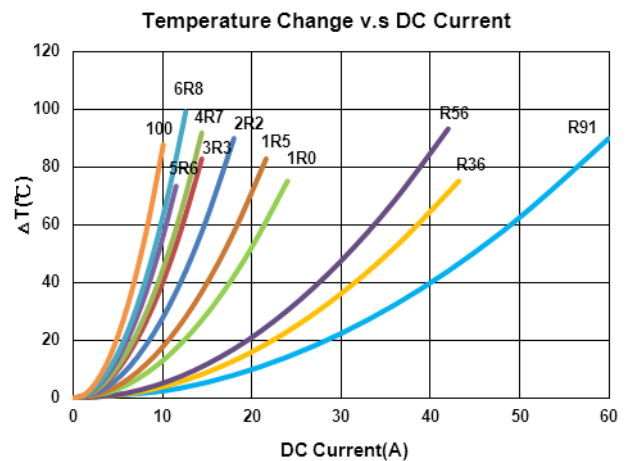
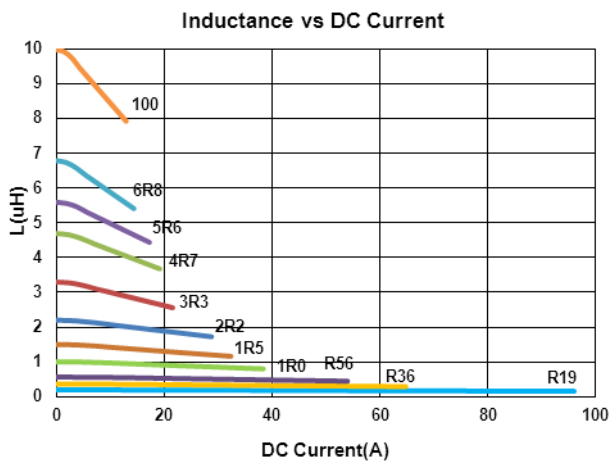

Molding Power Inductors – BMMA Series

Electrical Characteristics

Part Number	Inductance (uH)	Tolerance (±%)	Test Frequency (kHz)	RDC(mΩ) Max(Typ.)	Isat (A)Typ.	Irms (A)Typ.	Marking
BMMA001010452R2MX1	2.2	20	100	7(5.8)	16	14	2R2

Note: When ordering, please specify tolerance code. Tolerance: M=±20%

- Operating temperature range –55°C ~ 125°C (Including self - temperature rise)
- Isat for Inductance drop 20% from its value without current
- Irms for a 40°C temperature rise from 25°C ambient with current
- Withstand voltage: 25V DC
- Measure Equipment :
 L : WK 3260B or WK 6500P, 100kHz 0.25V
 RDC : CHEN HWA 502 or CHEN HWA 46502B
 Irms : CHROMA 1810

Test Instruments : WK3260B Impedance / Material Analyzer

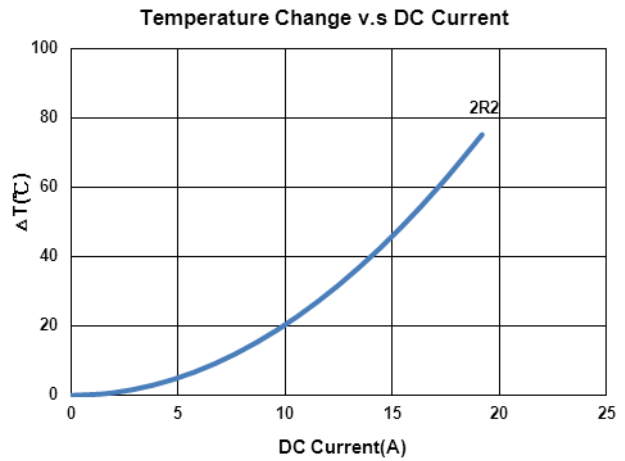
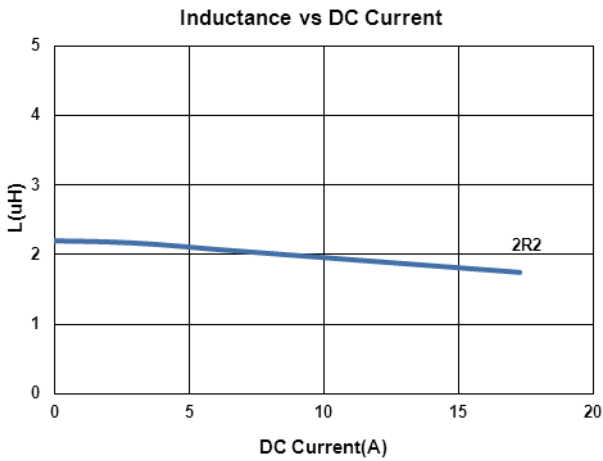

Molding Power Inductors – BMMA Series

Electrical Characteristics

Part Number	Inductance (uH)	Tolerance (±%)	Test Frequency (kHz)	RDC(mΩ) Max(Typ.)	Isat (A)Typ.	Irms (A)Typ.	Marking
BMMA001010452R2MX2	2.2	20	100	7(5.8)	16	14	2R2
BMMA001010453R3MX2	3.3	20	100	13.2(11)	14.5	11	3R3
BMMA001010454R7MX2	4.7	20	100	15(13.2)	13	10	4R7
BMMA001010456R8MX2	6.8	20	100	24(21.5)	9.5	7.5	6R8

Note: When ordering, please specify tolerance code. Tolerance: M=±20%

- Operating temperature range – 55°C ~ 125°C (Including self - temperature rise)
- Isat for Inductance drop 30% from its value without current
- I rms for a 40°C temperature rise from 25°C ambient with current
- Withstand voltage: 25V DC
- Measure Equipment :
 L : WK 3260B or WK 6500P, 100kHz 0.25V
 RDC : CHEN HWA 502 or CHEN HWA 46502B
 I rms : CHROMA 1810

Test Instruments : WK3260B Impedance / Material Analyzer

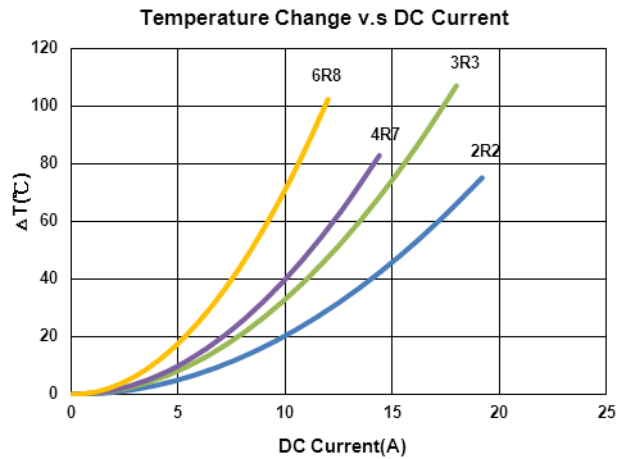
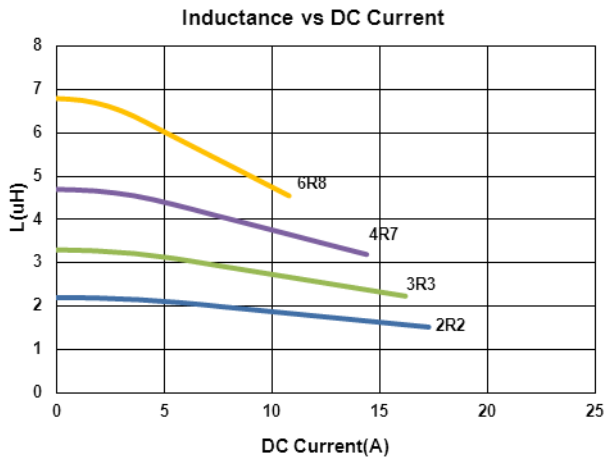

Molding Power Inductors – BMMA Series

Electrical Characteristics

Part Number	Inductance (uH)	Tolerance (±%)	Test Frequency (kHz)	RDC(mΩ) Max(Typ.)	Isat (A)Typ.	Irms (A)Typ.	Marking
BMMA00101050R47MX2	0.47	20	100	1.1(0.95)	50	36	R47

Note: When ordering, please specify tolerance code. Tolerance: M=±20%

- Operating temperature range—55°C ~ 125°C (Including self - temperature rise)
- Isat for Inductance drop 30% from its value without current
- I rms for a 40°C temperature rise from 25°C ambient with current
- Withstand voltage: 25V DC
- Measure Equipment :
 L : WK 3260B or WK 6500P, 100kHz 0.25V
 RDC : CHEN HWA 502 or CHEN HWA 46502B
 I rms : CHROMA 1810

Test Instruments : WK3260B Impedance / Material Analyzer

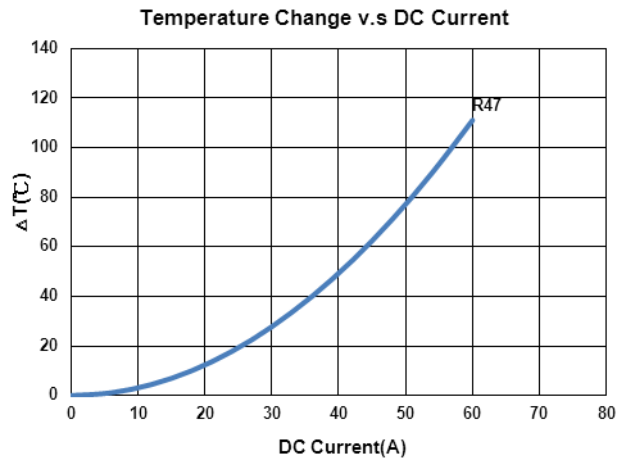
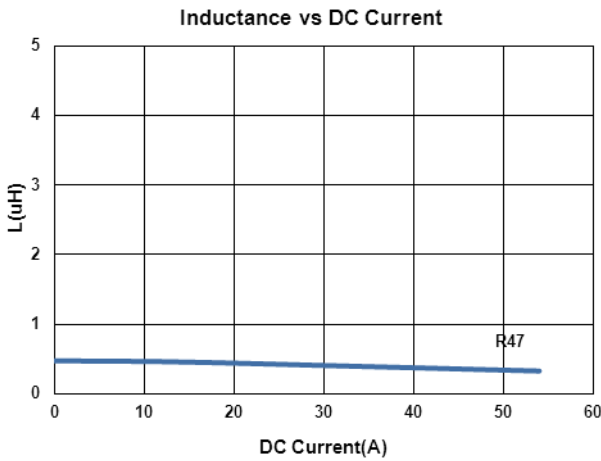

Please be sure to request approval specifications that provide further details of the products. Kindly note that the content of these specifications are subject to change or may be discontinued without prior notice. This product may not be designed/used in medical or high risk applications without Chilisin approval. Please contact our sales department before ordering.

Molding Power Inductors – BMMA Series

Electrical Characteristics

Part Number	Inductance (uH)	Tolerance (±%)	Test Frequency (kHz)	RDC(mΩ) Max(Typ.)	Isat (A)Typ.	Irms (A)Typ.	Marking
BMMA00131335R22MX1	0.22	20	100	1.3(1.1)	65	38.5	R22
BMMA00131335R33MX1	0.33	20	100	1.5(1.3)	62	36.5	R33
BMMA00131335R47MX1	0.47	20	100	2(1.6)	55	32	R47
BMMA00131335R56MX1	0.56	20	100	2.2(1.8)	51	29	R56
BMMA00131335R68MX1	0.68	20	100	2.5(2.3)	49	28	R68
BMMA001313351R0MX1	1.0	20	100	3.5(3.3)	40	24	1R0
BMMA001313351R5MX1	1.5	20	100	5.5(5.1)	35	19	1R5
BMMA001313352R2MX1	2.2	20	100	8(7.2)	29	16	2R2
BMMA001313353R3MX1	3.3	20	100	12(11)	27	12	3R3
BMMA001313354R7MX1	4.7	20	100	18(16)	22	9	4R7

Note: When ordering, please specify tolerance code. Tolerance: M=±20%

- Operating temperature range –55°C ~ 125°C (Including self - temperature rise)
- Isat for Inductance drop 20% from its value without current
- I rms for a 40°C temperature rise from 25°C ambient with current
- Withstand voltage: 25V DC
- Measure Equipment :
 - L : WK 3260B or WK 6500P, 100kHz 0.25V
 - RDC : CHEN HWA 502 or CHEN HWA 46502B
 - I rms : CHROMA 1810

Test Instruments : WK3260B Impedance / Material Analyzer

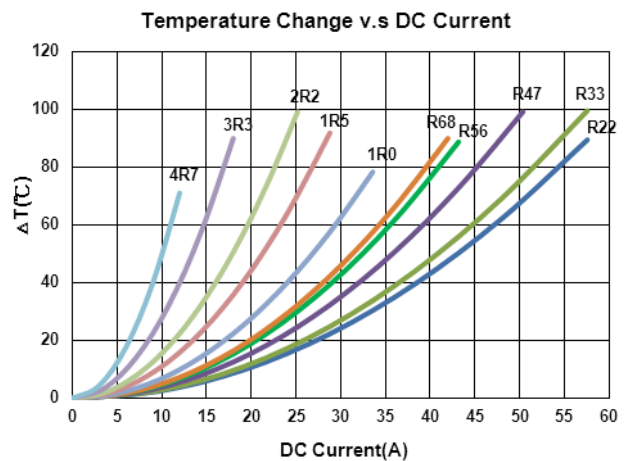
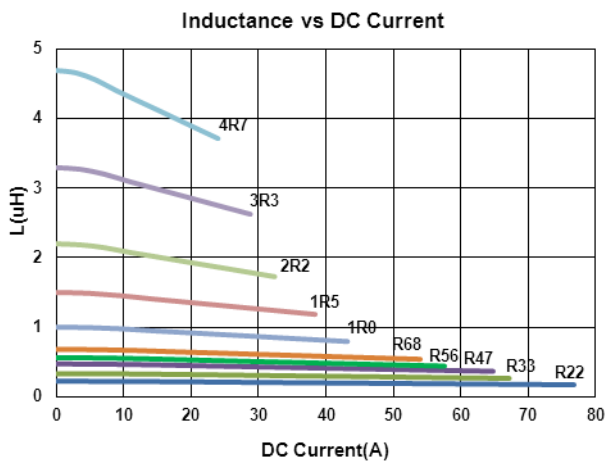

Molding Power Inductors – BMMA Series

Electrical Characteristics

Part Number	Inductance (uH)	Tolerance (±%)	Test Frequency (kHz)	RDC(mΩ) Max(Typ.)	Isat (A)Typ.	Irms (A)Typ.	Marking
BMMA00131335R15MV1	0.15	20	100	1.2(1)	75	41	R15
BMMA00131335R22MV1	0.22	20	100	1.3(1.1)	65	38.5	R22
BMMA00131335R33MV1	0.33	20	100	1.5(1.3)	62	36.5	R33
BMMA00131335R47MV1	0.47	20	100	2(1.6)	55	32	R47
BMMA00131335R60MV1	0.60	20	100	2.2(1.8)	51	29	R60
BMMA00131335R68MV1	0.68	20	100	2.5(2.3)	49	28	R68
BMMA00131335R82MV1	0.82	20	100	3(2.6)	44	25	R82
BMMA001313351R0MV1	1.0	20	100	3.5(3.3)	40	24	1R0
BMMA001313351R5MV1	1.5	20	100	5.5(5.1)	35	19	1R5
BMMA001313351R8MV1	1.8	20	100	7(6.5)	30	16.5	1R8
BMMA001313352R2MV1	2.2	20	100	8(7.2)	29	16	2R2
BMMA001313353R3MV1	3.3	20	100	12(11)	27	12	3R3
BMMA001313354R7MV1	4.7	20	100	15(14.3)	24	10	4R7
BMMA001313355R6MV1	5.6	20	100	19(18.3)	19	9.5	5R6
BMMA001313356R8MV1	6.8	20	100	22(19.8)	18	9	6R8
BMMA001313358R2MV1	8.2	20	100	28(24.8)	16	8.5	8R2
BMMA00131335100MV1	10	20	100	34(30.4)	14	7	100

Note: When ordering, please specify tolerance code. Tolerance: M=±20%

- Operating temperature range – 55°C ~ 125°C (Including self - temperature rise)
- Isat for Inductance drop 20% from its value without current
- I rms for a 40°C temperature rise from 25°C ambient with current
- Withstand voltage: 25V DC
- Measure Equipment :
 L : WK 3260B or WK 6500P, 100kHz 0.25V
 RDC : CHEN HWA 502 or CHEN HWA 46502B
 I rms : CHROMA 1810

Test Instruments : WK3260B Impedance / Material Analyzer

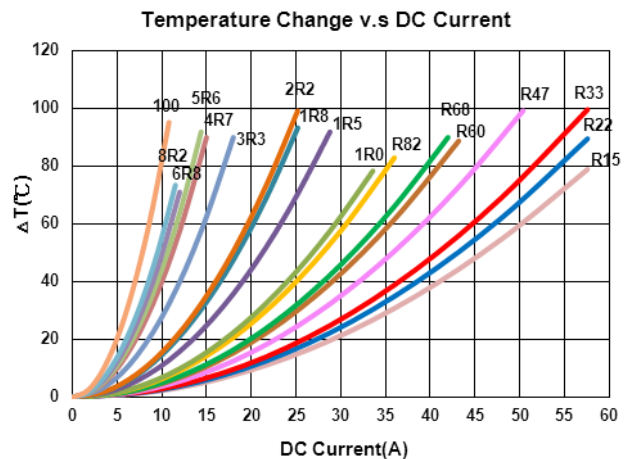
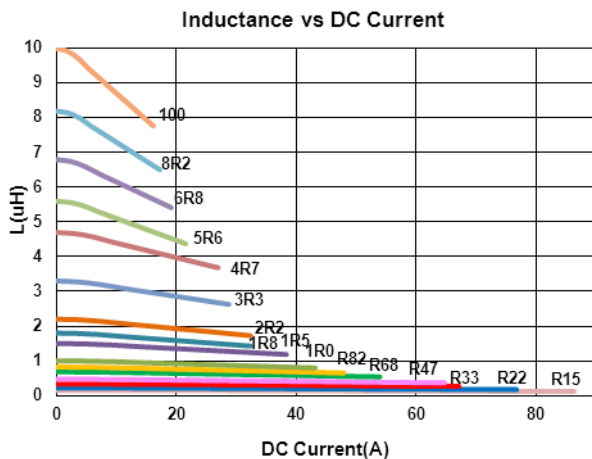

Please be sure to request approval specifications that provide further details of the products. Kindly note that the content of these specifications are subject to change or may be discontinued without prior notice. This product may not be designed/used in medical or high risk applications without Chilisin approval. Please contact our sales department before ordering.

Molding Power Inductors – BMMA Series

Electrical Characteristics

Part Number	Inductance (uH)	Tolerance (±%)	Test Frequency (kHz)	RDC(mΩ) Max(Typ.)	Isat (A)Typ.	Irms (A)Typ.	Marking
BMMA00131350R15MX1	0.15	20	100	0.7(0.55)	110	45	R15
BMMA00131350R36MX1	0.36	20	100	1.1(0.77)	75	41	R36
BMMA00131350R47MX1	0.47	20	100	1.3(1.1)	65	38	R47
BMMA00131350R50MX1	0.50	20	100	1.5(1.2)	55	36	R50
BMMA00131350R56MX1	0.56	20	100	1.5(1.2)	55	36	R56
BMMA00131350R68MX1	0.68	20	100	1.7(1.5)	54	34	R68
BMMA00131350R82MX1	0.82	20	100	2.1(1.8)	53	31	R82
BMMA00131350R1R0MX1	1.0	20	100	2.5(2.1)	50	29	1R0
BMMA00131350R1R5MX1	1.5	20	100	4.1(3.4)	48	23	1R5
BMMA00131350R2R2MX1	2.2	20	100	5.5(4.6)	32	20	2R2
BMMA00131350R3R3MX1	3.3	20	100	9.2(7.7)	32	15	3R3
BMMA00131350R4R7MX1	4.7	20	100	15(12.8)	27	12	4R7
BMMA00131350R6R8MX1	6.8	20	100	18.5(15.4)	21	11	6R8

Note: When ordering, please specify tolerance code. Tolerance: M=±20%

- Operating temperature range – 55°C ~ 125°C (Including self - temperature rise)
- Isat for Inductance drop 20% from its value without current
- Iirms for a 40°C temperature rise from 25°C ambient with current
- Withstand voltage: 25V DC
- Measure Equipment :
 L : WK 3260B or WK 6500P, 100kHz 0.25V
 RDC : CHEN HWA 502 or CHEN HWA 46502B
 Iirms : CHROMA 1810

Test Instruments : WK3260B Impedance / Material Analyzer

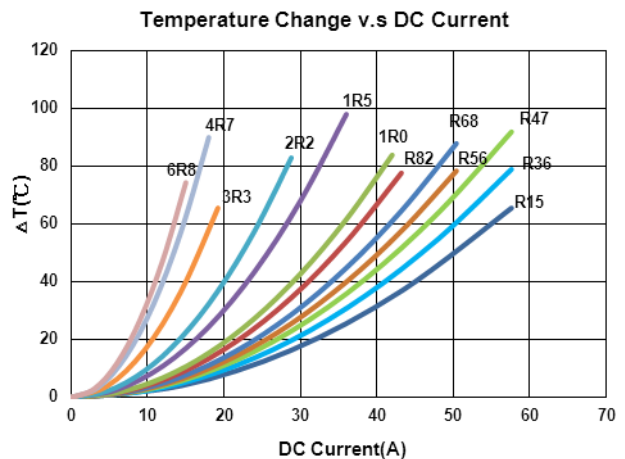
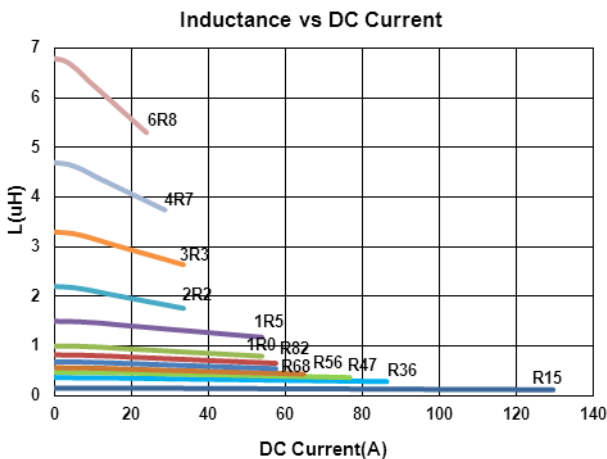

Molding Power Inductors – BMMA Series

Electrical Characteristics

Part Number	Inductance (uH)	Tolerance (±%)	Test Frequency (kHz)	RDC(mΩ) Max(Typ.)	Isat (A)Typ.	Irms (A)Typ.	Marking
BMMA00131350R82MX2	0.82	20	100	1.67(1.45)	39	30	R82
BMMA001313501R0MX2	1.0	20	100	2.2(1.9)	35	26	1R0
BMMA001313501R5MX2	1.5	20	100	3.2(2.8)	33	23	1R5
BMMA001313502R2MX2	2.2	20	100	5(4)	24	15	2R2
BMMA001313503R3MX2	3.3	20	100	7(5.9)	22	14	3R3
BMMA00131350100MX2	10	20	100	22(19)	12	9	100

Note: When ordering, please specify tolerance code. Tolerance: M=±20%

- Operating temperature range –55°C ~ 125°C (Including self - temperature rise)
- Isat for Inductance drop 30% from its value without current
- Irms for a 40°C temperature rise from 25°C ambient with current
- Withstand voltage: 25V DC
- Measure Equipment :
 L : WK 3260B or WK 6500P, 100kHz 0.25V
 RDC : CHEN HWA 502 or CHEN HWA 46502B
 Irms : CHROMA 1810

Test Instruments : WK3260B Impedance / Material Analyzer

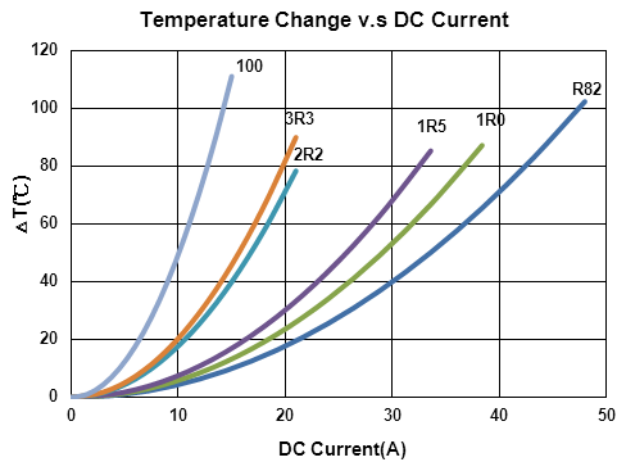
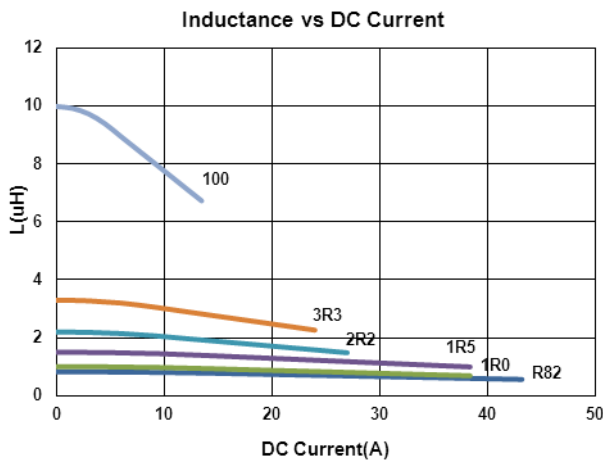

Please be sure to request approval specifications that provide further details of the products. Kindly note that the content of these specifications are subject to change or may be discontinued without prior notice. This product may not be designed/used in medical or high risk applications without Chilisin approval. Please contact our sales department before ordering.

Molding Power Inductors – BMMA Series

Electrical Characteristics

Part Number	Inductance (uH)	Tolerance (±%)	Test Frequency (kHz)	RDC(mΩ) Max(Typ.)	Isat (A)Typ.	Irms (A)Typ.	Marking
BMMA00131350R10MV1	0.10	20	100	0.6(0.53)	118	55	R10
BMMA00131350R22MV1	0.22	20	100	0.8(0.64)	110	51	R22
BMMA00131350R33MV1	0.33	20	100	1.1(0.85)	80	42	R33
BMMA00131350R47MV1	0.47	20	100	1.3(1.1)	65	38	R47
BMMA00131350R56MV1	0.56	20	100	1.5(1.3)	55	36	R56
BMMA00131350R68MV1	0.68	20	100	1.7(1.5)	54	34	R68
BMMA00131350R82MV1	0.82	20	100	2.3(2.0)	53	31	R82
BMMA00131350R1R0MV1	1.0	20	100	2.5(2.1)	50	29	1R0
BMMA00131350R1R5MV1	1.5	20	100	4.1(3.4)	48	23	1R5
BMMA00131350R1R8MV1	1.8	20	100	4.9(4.2)	40	19	1R8
BMMA00131350R2R2MV1	2.2	20	100	5.5(4.6)	32	20	2R2
BMMA00131350R3R3MV1	3.3	20	100	9.2(7.7)	32	15	3R3
BMMA00131350R4R7MV1	4.7	20	100	15(12.8)	27	12	4R7
BMMA00131350R5R6MV1	5.6	20	100	16.5(14)	22	11.5	5R6
BMMA00131350R6R8MV1	6.8	20	100	18.5(15.4)	21	11	6R8
BMMA00131350R7R8MV1	7.8	20	100	20.5(17.2)	18	10	7R8
BMMA00131350R8R2MV1	8.2	20	100	22.5(18.9)	18	9.5	8R2
BMMA00131350R100MV1	10	20	100	25.5(21.4)	16	9	100

Note: When ordering, please specify tolerance code. Tolerance: M=±20%

- Operating temperature range – 55°C ~ 125°C (Including self - temperature rise)
- Isat for Inductance drop 30% from its value without current
- I rms for a 40°C temperature rise from 25°C ambient with current
- Withstand voltage: 25V DC
- Measure Equipment :
 L : WK 3260B or WK 6500P, 100kHz 0.25V
 RDC : CHEN HWA 502 or CHEN HWA 46502B
 I rms : CHROMA 1810

Test Instruments : WK3260B Impedance / Material Analyzer

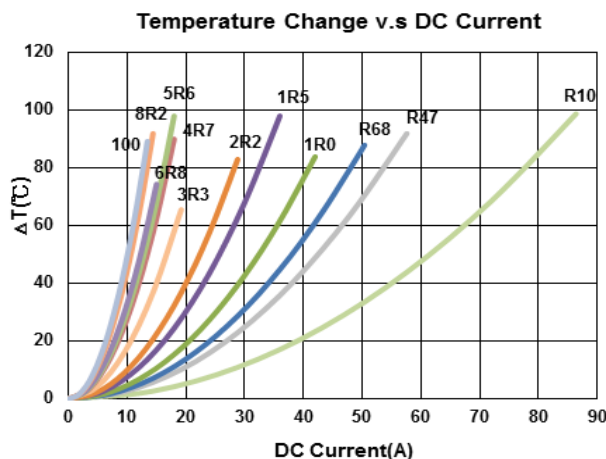
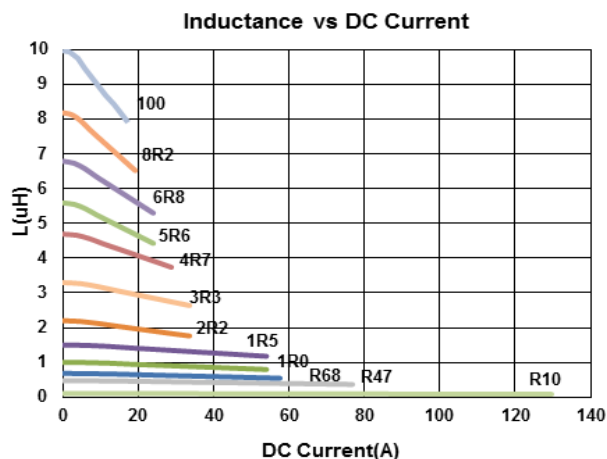

Please be sure to request approval specifications that provide further details of the products. Kindly note that the content of these specifications are subject to change or may be discontinued without prior notice. This product may not be designed/used in medical or high risk applications without Chilisin approval. Please contact our sales department before ordering.

Molding Power Inductors – BMMA Series

Electrical Characteristics

Part Number	Inductance (uH)	Tolerance (±%)	Test Frequency (kHz)	RDC(mΩ) Max(Typ.)	Isat (A)Typ.	Irms (A)Typ.	Marking
BMMA00131364R22MV1	0.22	20	100	0.7(0.63)	112	53	R22
BMMA00131364R33MV1	0.33	20	100	0.9(0.83)	65	46	R33
BMMA00131364R47MV1	0.47	20	100	1.2(1)	63	41	R47
BMMA00131364R56MV1	0.56	20	100	1.4(1.2)	62	37	R56
BMMA00131364R68MV1	0.68	20	100	1.6(1.4)	60	35	R68
BMMA00131364R82MV1	0.82	20	100	1.9(1.6)	50	33	R82
BMMA001313641R0MV1	1.0	20	100	2(1.7)	49	32	1R0
BMMA001313641R5MV1	1.5	20	100	3(2.5)	45	27	1R5
BMMA001313641R8MV1	1.8	20	100	3.2(2.8)	41	24	1R8
BMMA001313642R2MV1	2.2	20	100	4.2(3.5)	40	22	2R2
BMMA001313643R3MV1	3.3	20	100	6.8(5.7)	35	18	3R3
BMMA001313644R7MV1	4.7	20	100	11.2(9.3)	30	13.5	4R7
BMMA001313645R6MV1	5.6	20	100	10(9.3)	32	13.5	5R6
BMMA001313646R8MV1	6.8	20	100	14(13.1)	16.5	11.5	6R8
BMMA001313648R2MV1	8.2	20	100	15.5(14.5)	16	10.5	8R2
BMMA00131364100MV1	10	20	100	17.2(16.4)	15.5	10	100

Note: When ordering, please specify tolerance code. Tolerance: M=±20%

- Operating temperature range –55°C ~ 125°C (Including self - temperature rise)
- Isat for Inductance drop 20% from its value without current
- I rms for a 40°C temperature rise from 25°C ambient with current
- Withstand voltage: 25V DC
- Measure Equipment :
 L : WK 3260B or WK 6500P, 100kHz 0.25V
 RDC : CHEN HWA 502 or CHEN HWA 46502B
 I rms : CHROMA 1810

Test Instruments : WK3260B Impedance / Material Analyzer

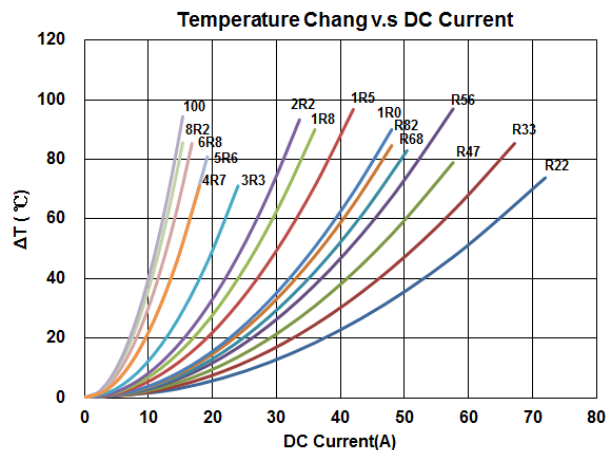
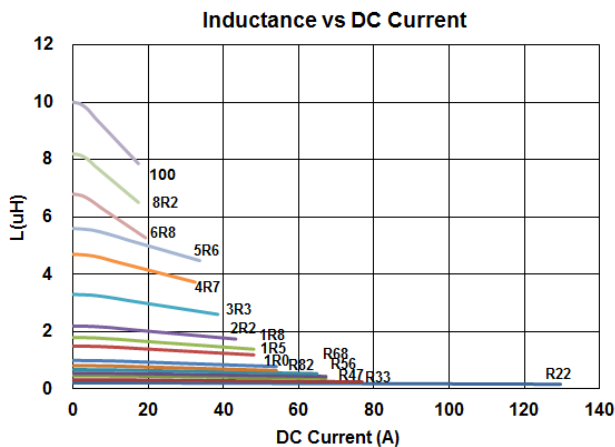

Please be sure to request approval specifications that provide further details of the products. Kindly note that the content of these specifications are subject to change or may be discontinued without prior notice. This product may not be designed/used in medical or high risk applications without Chilisin approval. Please contact our sales department before ordering.

Molding Power Inductors – BMMA Series

Electrical Characteristics

Part Number	Inductance (uH)	Tolerance (±%)	Test Frequency (kHz)	RDC(mΩ) Max(Typ.)	Isat (A)Typ.	Irms (A)Typ.	Marking
BMMA001717701R0MV1	1.0	20	100	1.38(1.28)	73	48	1R0
BMMA001717702R2MV1	2.2	20	100	2.53(2.4)	62	35	2R2
BMMA001717703R3MV1	3.3	20	100	3.88(3.68)	54	28	3R3
BMMA001717704R7MV1	4.7	20	100	5.11(4.84)	41	25	4R7
BMMA001717706R8MV1	6.8	20	100	8.83(8.37)	32	19	6R8

Note: When ordering, please specify tolerance code. Tolerance: M=±20%

- Operating temperature range –55°C ~ 125°C (Including self - temperature rise)
- Isat for Inductance drop 20% from its value without current
- I rms for a 40°C temperature rise from 25°C ambient with current
- Withstand voltage: 25V DC
- Measure Equipment :
 L : WK 3260B or WK 6500P, 100kHz 0.25V
 RDC : CHEN HWA 502 or CHEN HWA 46502B
 I rms : CHROMA 1810

Test Instruments : WK3260B Impedance / Material Analyzer

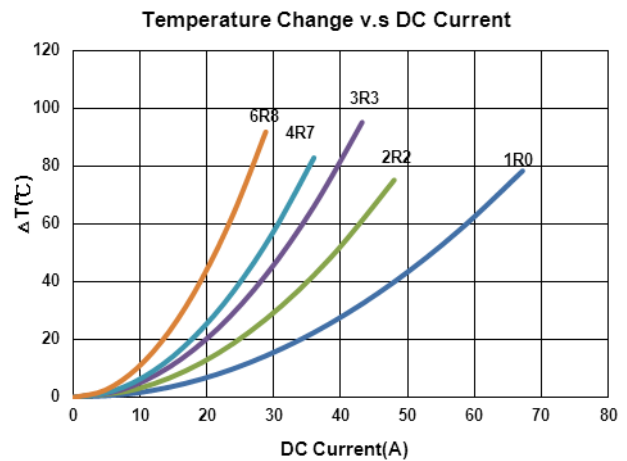
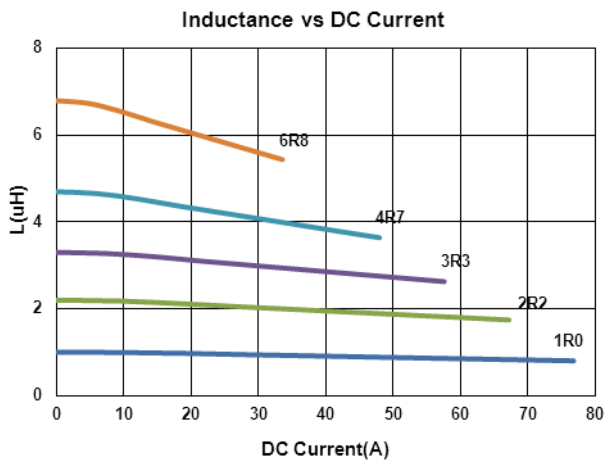

Please be sure to request approval specifications that provide further details of the products. Kindly note that the content of these specifications are subject to change or may be discontinued without prior notice. This product may not be designed/used in medical or high risk applications without Chilisin approval. Please contact our sales department before ordering.

Molding Power Inductors – BMMA Series

Packaging Specifications

Tape Dimensions

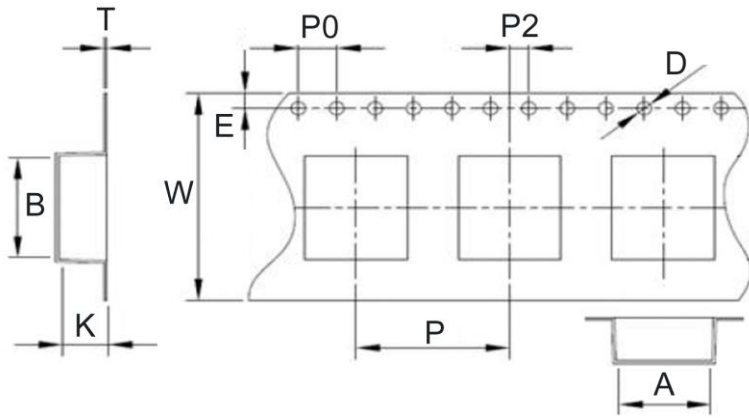

Reel Dimensions

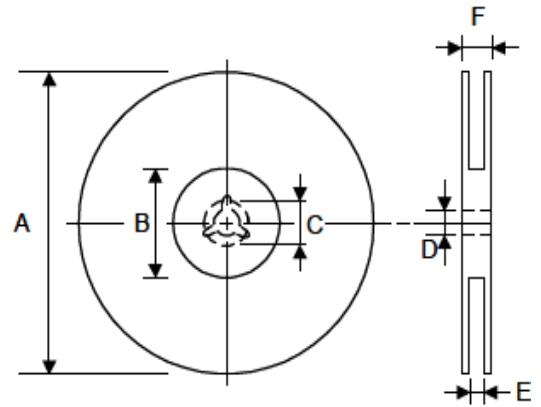

Dimensions in mm

TYPE	Tape Dimensions										Reel Dimensions						Quantity PCS / REEL
	A	B	K	T	D	E	W	P	P0	P2	A	B	C	D	E	F	
BMMA00040412	4.5	4.9	1.7	0.35	1.5	1.75	12	8	4	2	330	100	21.5	13	12.4	17.4	2000
BMMA00040420	4.4	4.9	2.4	0.35	1.5	1.75	12	8	4	2	330	100	21.5	13	12.4	17.4	2000
BMMA00050512	5.4	5.8	1.4	0.3	1.5	1.75	12	8	4	2	330	100	21.5	13	12.4	17.4	1000
BMMA00050518	5.4	5.8	1.95	0.3	1.5	1.75	12	8	4	2	330	100	21.5	13	12.4	17.4	1000
BMMA00050520	5.4	5.8	2.3	0.3	1.5	1.75	12	8	4	2	330	100	21.5	13	12.4	17.4	1000
BMMA00050530-Xx	5.0	5.4	3.2	0.35	1.5	1.75	12	8	4	2	330	100	21.5	13	12.4	17.4	1000
BMMA00050530-V1	5.4	5.9	3.3	0.35	1.5	1.75	12	8	4	2	330	100	21.5	13	12.4	17.4	1000
BMMA00060618	6.9	7.5	2.1	0.3	1.5	1.75	16	12	4	2	330	100	21.5	13	16.4	21.4	1000
BMMA00060624	6.9	7.6	2.7	0.35	1.5	1.75	16	12	4	2	330	100	21.5	13	16.4	21.4	1000
BMMA00060630	6.9	7.6	3.4	0.35	1.5	1.75	16	12	4	2	330	100	21.5	13	16.4	21.4	1000
BMMA00060640	6.9	7.5	4.3	0.4	1.5	1.75	16	12	4	2	330	100	21.5	13	16.4	21.4	1000
BMMA00060650-X1	6.9	7.5	5.2	0.4	1.5	1.75	16	12	4	2	330	100	21.5	13	16.4	21.4	500
BMMA00060650-X2	6.9	7.5	5.2	0.4	1.5	1.75	16	12	4	2	330	100	21.5	13	16.4	21.4	500
BMMA00060650-V1	6.9	7.5	5.2	0.4	1.5	1.75	16	12	4	2	330	100	21.5	13	16.4	21.4	500
BMMA00080830	8.6	8.8	3.3	0.4	1.5	1.75	16	12	4	2	330	100	21.5	13	16.4	21.4	500
BMMA00080840	8.3	8.5	4.2	0.35	1.5	1.75	16	12	4	2	330	100	21.5	13	16.4	21.4	500
BMMA00101015	10.4	11.5	2.3	0.35	1.5	1.75	24	16	4	2	330	100	21.5	13	24.2	29.2	500
BMMA00101030	10.4	11.5	3.4	0.35	1.5	1.75	24	16	4	2	330	100	21.5	13	24.2	29.2	500
BMMA00101040	10.4	11.5	4.5	0.35	1.5	1.75	24	16	4	2	330	100	21.5	13	24.2	29.2	500
BMMA00101045	10.4	11.5	4.9	0.5	1.5	1.75	24	16	4	2	330	100	21.5	13	24.2	29.2	500
BMMA00101050	10.4	11.5	5.8	0.5	1.5	1.75	24	16	4	2	330	100	21.5	13	24.2	29.2	500
BMMA00131335-X1	13.0	13.9	3.6	0.35	1.5	1.75	24	16	4	2	330	100	21.5	13	24.2	29.2	500
BMMA00131335-V1	13.0	13.9	3.8	0.35	1.5	1.75	24	16	4	2	330	100	21.5	13	24.2	29.2	500
BMMA00131350	13.4	14.0	5.4	0.4	1.5	1.75	24	16	4	2	330	100	21.5	13	24.2	29.2	250
BMMA00131364	13.4	14.0	6.8	0.4	1.5	1.75	24	16	4	2	330	100	21.5	13	24.2	29.2	250
BMMA00171770	17.45	18.5	7.8	0.5	1.5	1.75	32	24	4	2	330	100	21.5	13	32	37	100