

BWVH Series



BWVH series, an automatic assembly constructed power inductor, is shielded with magnetic resin and suitable for portable DC-DC converter applications.

Features

- RoHS, Halogen Free and REACH Compliance
- Shielded with magnetic resin
- Low profile, miniature package size and wide inductance range.
- Low DCR and high rated current.

Applications

- Smart phone
- DSC
- Tablet PC and other portable devices
- DC/DC converters

Product Identification

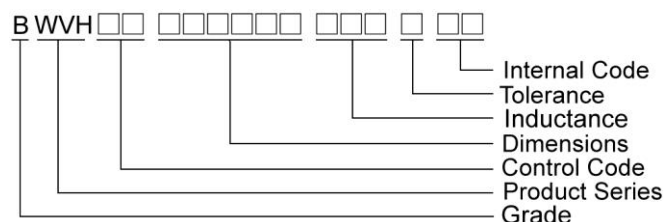

Shape and Dimensions

Figure 1

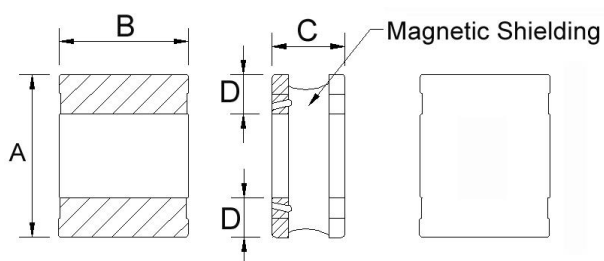

Recommended Pattern

Figure 2

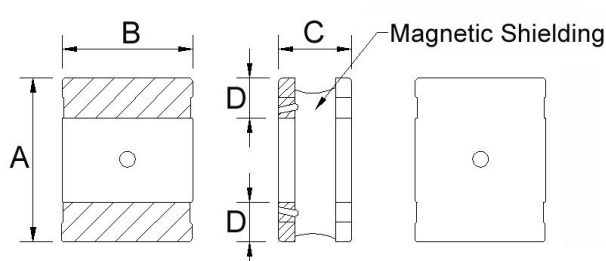

Recommended Pattern

Dimensions in mm

TYPE	FIG	A	B	C	D	H	I	J
BWVH00201610_H1	1	2.0±0.25	1.6±0.25	1.02 Max	0.6	1.8	0.8	0.8
BWVH00252010_H1	1	2.5±0.25	2.0±0.25	1.00 Max	0.8	2.2	0.85	0.8
BWVH00252012_H1	2	2.5±0.25	2.0±0.25	1.2±0.05	0.8	2.2	0.85	0.8

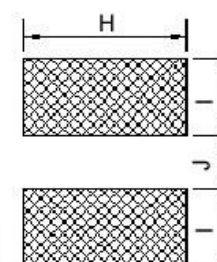

Sealed Power Inductors – BWVH Series

Shape and Dimensions

Figure 3

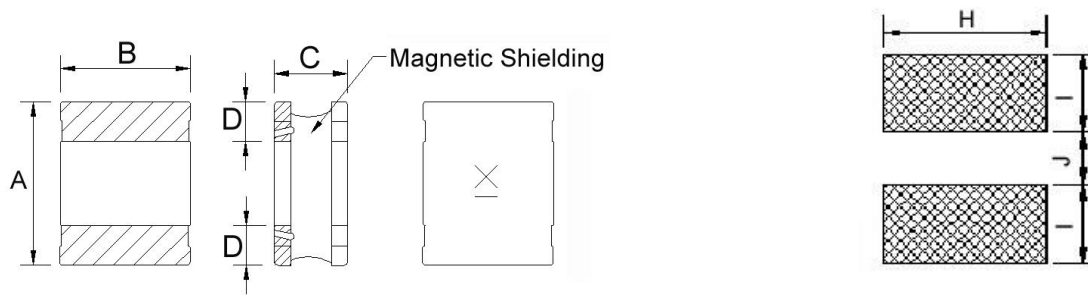

Recommended Pattern

Dimensions in mm

TYPE	FIG	A	B	C	D	H	I	J
BWVH00252012	3	2.5±0.25	2.0±0.25	1.2±0.05	0.8	2.2	0.85	0.8

Sealed Power Inductors - BWVH Series

Electrical Characteristics

Part Number	Inductance (uH)	Tolerance (±%)	Test Frequency (MHz)	RDC (Ω) ±30%	Isat (mA) Typ. (Max)	Irms (mA) Typ. (Max)
BWVH00201610R24□H1	0.24	20, 30	1	0.048	3700(3300)	2500(2100)
BWVH00201610R33□H1	0.33	20, 30	1	0.048	3400(3000)	2500(2100)
BWVH00201610R47□H1	0.47	20, 30	1	0.072	2900(2600)	2100(1800)
BWVH00201610R56□H1	0.56	20, 30	1	0.072	2700(2400)	2100(1800)
BWVH00201610R68□H1	0.68	20, 30	1	0.092	2500(2200)	1800(1500)
BWVH002016101R0□H1	1.0	20, 30	1	0.110	2200(2000)	1500(1200)
BWVH002016102R2□H1	2.2	20, 30	1	0.205	1400(1200)	1150(970)
BWVH002016103R3□H1	3.3	20, 30	1	0.380	1050(940)	900(800)
BWVH002016104R7□H1	4.7	20, 30	1	0.520	900(800)	800(680)
BWVH00201610100□H1	10	20, 30	1	1.100	620(550)	450(380)

Note: When ordering, please specify tolerance code. Tolerance: M=±20% , T =±30%

- Operating temperature range—55°C ~ 125°C (Including self - temperature rise)
- Isat for Inductance drop 30% from its value without current
- I rms for a 40°C temperature rise from 25°C ambient with current
- Measure Equipment :
- L : Agilent HP4287A+Agilent HP16197A, 1MHz 200mV
- RDC : DIGITAL MILLINHM METER CHROMA 16502, or equivalent
- Isat & I rms : Agilent HP4284A

Test Instruments : HP4284A Material/Impedance Analyzer

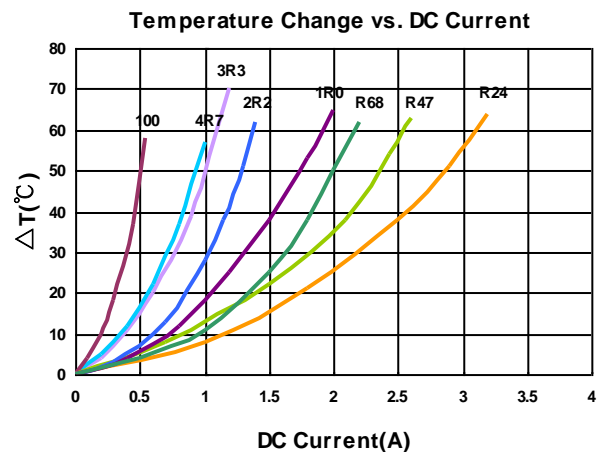
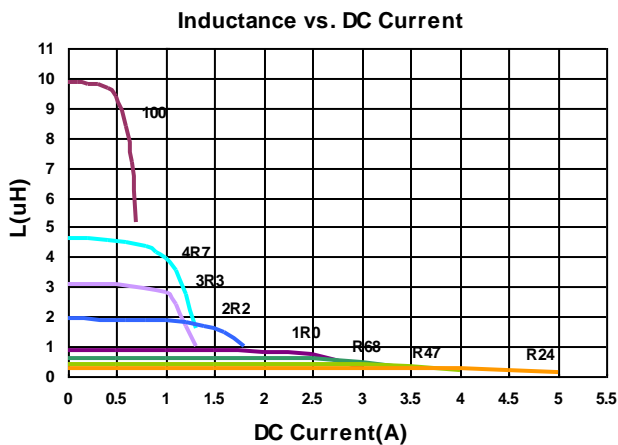

Sealed Power Inductors - BWVH Series

Electrical Characteristics

Part Number	Inductance (uH)	Tolerance (±%)	Test Frequency (MHz)	RDC (Ω) ±30%	Isat (mA) Typ. (Max)	Irms (mA) Typ. (Max)
BWVH00252010R24□H1	0.24	20, 30	1	0.030	4700(4200)	3600(3000)
BWVH00252010R47□H1	0.47	20, 30	1	0.043	3300(3000)	2700(2300)
BWVH00252010R68□H1	0.68	20, 30	1	0.062	2800(2500)	2300(1900)
BWVH002520101R0□H1	1.0	20, 30	1	0.080	2300(2100)	1900(1600)
BWVH002520102R2□H1	2.2	20, 30	1	0.135	1600(1400)	1400(1100)
BWVH002520104R7□H1	4.7	20, 30	1	0.330	1000(900)	850(720)
BWVH00252010100□H1	10	20, 30	1	0.670	720(640)	580(490)

Note: When ordering, please specify tolerance code. Tolerance: M=±20% , T =±30%

- Operating temperature range -55°C ~ 125°C (Including self - temperature rise)
- Isat for Inductance drop 30% from its value without current
- I rms for a 40°C temperature rise from 25°C ambient with current
- Measure Equipment :
- L : Agilent HP4287A+Agilent HP16197A, 1MHz 200mV
- RDC : DIGITAL MILLINHM METER CHROMA 16502, or equivalent
- Isat & I rms : Agilent HP4284A

Test Instruments : HP4284A Material/Impedance Analyzer

Inductance vs. DC Current

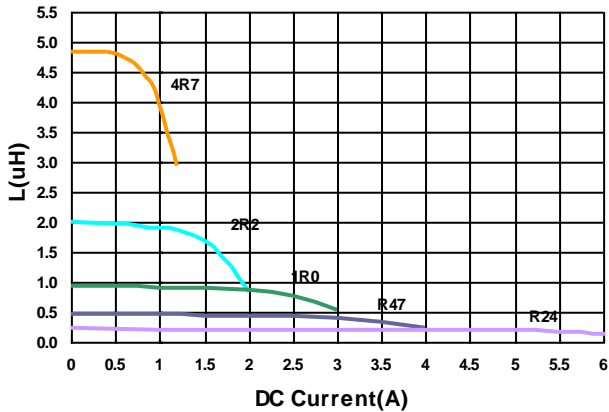

Temperature Change vs. DC Current

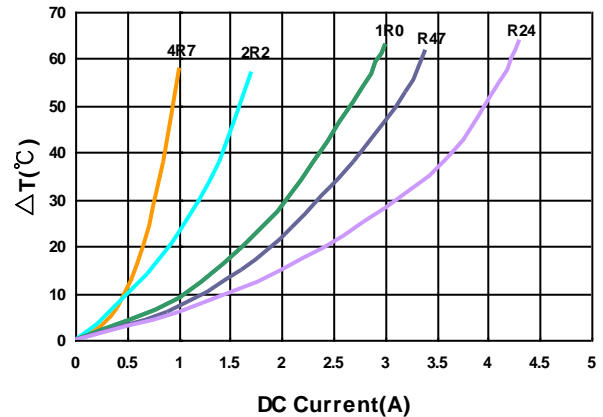

Please be sure to request approval specifications that provide further details of the products. Kindly note that the content of these specifications are subject to change or may be discontinued without prior notice. This product may not be designed/used in medical or high risk applications without Chilisin approval. Please contact our sales department before ordering.

Sealed Power Inductors - BWVH Series

Electrical Characteristics

Part Number	Inductance (uH)	Tolerance (±%)	Test Frequency (MHz)	RDC (Ω) ±30%	Isat (mA) Typ. (Max)	Irms (mA) Typ. (Max)
BWVH00252012R47□H1	0.47	20, 30	1	0.031	4100(3700)	3100(2600)
BWVH00252012R68□H1	0.68	20, 30	1	0.031	3100(2900)	3100(2600)
BWVH002520121R0□H1	1.0	20, 30	1	0.049	3200(3000)	3000(2500)
BWVH002520121R5□H1	1.5	20, 30	1	0.088	2300(2100)	2200(1800)
BWVH002520122R2□H1	2.2	20, 30	1	0.099	2200(2000)	2000(1700)
BWVH002520123R3□H1	3.3	20, 30	1	0.190	1400(1200)	1200(1000)
BWVH002520124R7□H1	4.7	20, 30	1	0.235	1300(1100)	1100(930)
BWVH00252012100□H1	10	20, 30	1	0.510	920(820)	800(680)

Note: When ordering, please specify tolerance code. Tolerance: M=±20% , T =±30%

- Operating temperature range – 55°C ~ 125°C (Including self - temperature rise)
- Isat for Inductance drop 30% from its value without current
- I rms for a 40°C temperature rise from 25°C ambient with current
- Measure Equipment :
- L : Agilent HP4287A+Agilent HP16197A, 1MHz 200mV
- RDC : DIGITAL MILLINHM METER CHROMA 16502, or equivalent
- Isat & I rms : Agilent HP4284A

Test Instruments : HP4284A Material/Impedance Analyzer

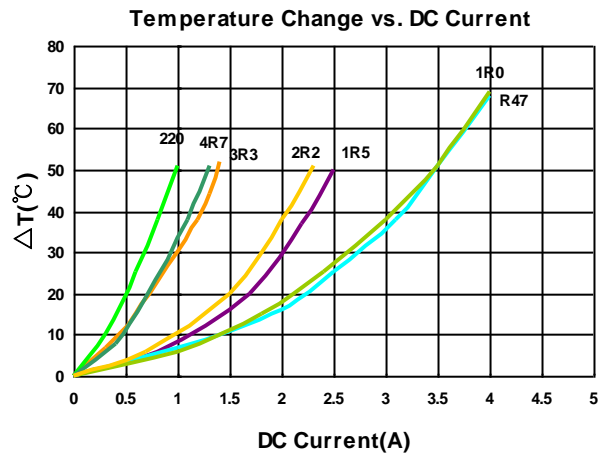
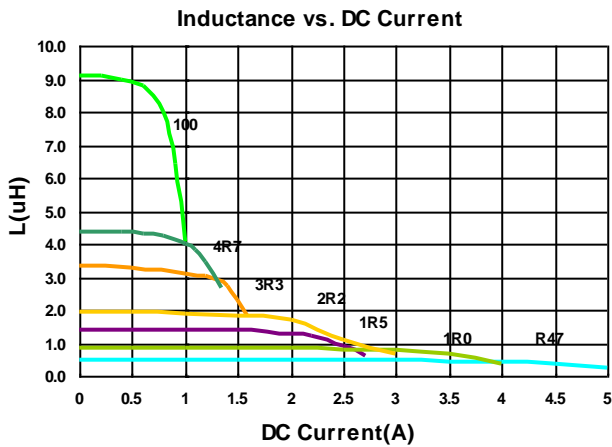

Please be sure to request approval specifications that provide further details of the products. Kindly note that the content of these specifications are subject to change or may be discontinued without prior notice. This product may not be designed/used in medical or high risk applications without Chilisin approval. Please contact our sales department before ordering.

Sealed Power Inductors - BWVH Series

Electrical Characteristics

Part Number	Inductance (uH)	Tolerance (±%)	Test Frequency (MHz)	RDC (Ω) ±30%	Isat (mA) Typ. (Max)	Irms (mA) Typ. (Max)	Marking
BWVH00252012R24□00	0.24	20, 30	1	0.021	4700(4200)	3800(3200)	E
BWVH00252012R33□00	0.33	20, 30	1	0.027	4200(3700)	3000(2500)	G
BWVH00252012R47□00	0.47	20, 30	1	0.027	3600(3400)	3000(2500)	J
BWVH00252012R50□00	0.50	20, 30	1	0.027	3600(3400)	3000(2500)	D
BWVH00252012R68□00	0.68	20, 30	1	0.036	2900(2600)	2800(2300)	H
BWVH002520121R0□00	1.0	20, 30	1	0.037	2700(2450)	2600(2200)	A
BWVH002520121R5□00	1.5	20, 30	1	0.075	2200(1900)	1900(1600)	I
BWVH002520122R2□00	2.2	20, 30	1	0.080	1900(1800)	1800(1500)	B
BWVH002520124R7□00	4.7	20, 30	1	0.195	1200(1000)	1100(930)	C
BWVH00252012100□00	10	20, 30	1	0.400	900(800)	800(680)	F
BWVH00252012330□00	33	20, 30	1	1.550	430(380)	380(340)	L
BWVH00252012470□00	47	20, 30	1	1.700	390(350)	340(300)	K

Note: When ordering, please specify tolerance code. Tolerance: M=±20% , T =±30%

- Operating temperature range –55°C ~ 125°C (Including self - temperature rise)
- Isat for Inductance drop 30% from its value without current
- I rms for a 40°C temperature rise from 25°C ambient with current
- Measure Equipment :
- L : Agilent HP4287A+Agilent HP16197A, 1MHz 200mV
RDC : DIGITAL MILLINHM METER CHROMA 16502, or equivalent
Isat & I rms : Agilent HP4284A

Test Instruments : HP4284A Material/Impedance Analyzer

Inductance vs. DC Current

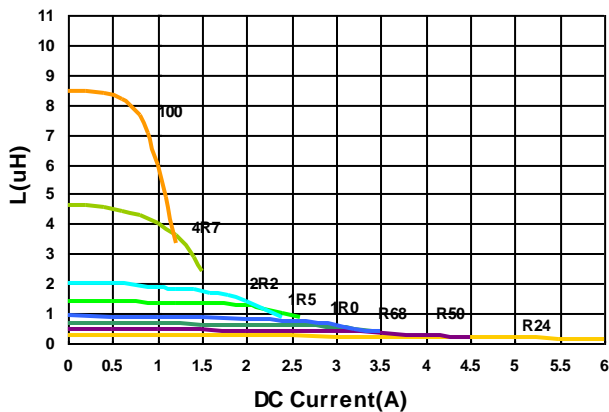

Temperature Change vs. DC Current

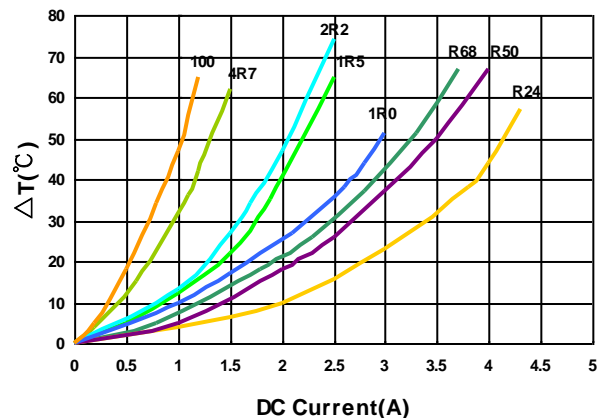

Please be sure to request approval specifications that provide further details of the products. Kindly note that the content of these specifications are subject to change or may be discontinued without prior notice. This product may not be designed/used in medical or high risk applications without Chilisin approval. Please contact our sales department before ordering.

Sealed Power Inductors - BWVH Series

Packaging Specifications

Tape Dimensions

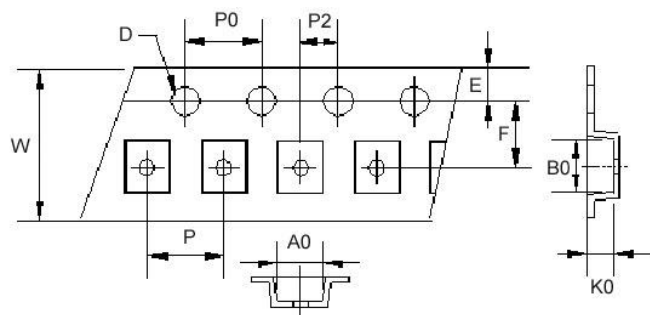

Reel Dimensions

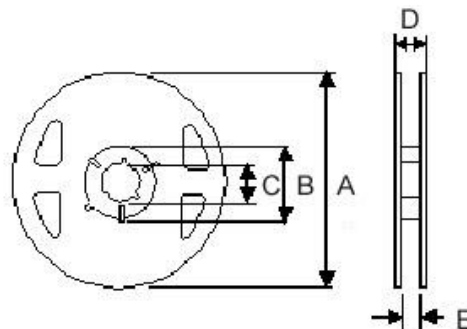

Dimensions in mm

TYPE	Tape Dimensions										Reel Dimensions					Quantity
	A0	B0	K0	D	E	F	W	P	P0	P2	A	B	C	D	E	PCS / Reel
BWVH00201610	1.9	2.2	1.15	1.55	1.75	3.5	8	4	4	2	180	60	13	14.4	8.4	2000
BWVH00252010	2.4	2.7	1.15	1.55	1.75	3.5	8	4	4	2	180	60	13	14.4	8.4	2000
BWVH00252012	2.4	2.7	1.35	1.55	1.75	3.5	8	4	4	2	180	60	13	14.4	8.4	2000