









# Directional DAS Series

## 2xMiMo 4G/5G Antenna + 1350-1550MHz

PD698-3800M2NF



### Features & Applications:

-  4G / 5G-FR1 698-3800MHz
-  Including 1350-1550MHz band
-  2-Port MiMo
-  In-building wall mount
-  Directional radiation pattern
-  Low PIM and SAR compliant
-  Connector N-Female as standard
-  For 4.3-10 Female version use P/N: PD698-3800M243

## ELECTRICAL SPECIFICATIONS

### PD698-3800M2NF

Frequency range	MHz		698-960	1350-1550	1710-2700	3300-3800
Gain	dBi		6.0±1	8.0±1	9.0±1	9.0±1
Polarization			±90deg V+H			
Beam width	Horizontal	deg	90	75	70	70
	Vertical		75	60	55	55
VSWR			≤2.0	≤1.7	≤1.7	≤1.7
Front-to-back ratio	dB		>15	>15	>15	>15
PIM,3rd order,2x20W	dBc		≤-150			N/A
Max. input power	W		50			
Impedance	Ohm		50			
SAR compliance			Compliant based on whole-body SAR limit RF Exposure calculation (CEI EN 50383)			

## MECHANICAL SPECIFICATIONS

### PD698-3800M2NF

<b>Dimension (W x L x H)</b>		<b>Housing Material</b>	<b>Color</b>	<b>Weight with mounting kit</b>	<b>Mounting Kit</b>
315 x 195 x 74 mm (12.40 x 7.68 x 2.91 inch)		ABS, UV Protected	White RAL9003	0.8 kg (1.76 lbs)	Wall mount (standard)
<b>Wireless Technology</b>	<b>No. of Port</b>	<b>Cable Length</b>		<b>Cable Type</b>	<b>Connector Type</b>
4G,5G FR1	2	1Ft (0.3m)		Ø 0.160" low loss SFF-50-3	NF

## ENVIRONMENTAL SPECIFICATIONS

### PD698-3800M2NF

<b>Operating Temperature</b>	<b>Storage Temperature</b>	<b>RoHS Compliant</b>	<b>Ingress Protection</b>	<b>Warranty</b>
-40 / +60° C	-40 / +60° C	Yes	IP50	2 years

Radiation Pattern –Vertical and Horizontal Plane

PD698-3800M2NF

Vertical

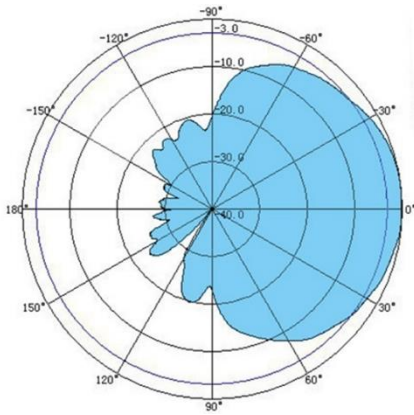

698-960MHz

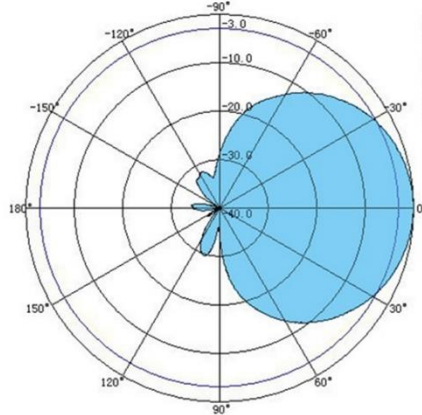

1350-1550MHz

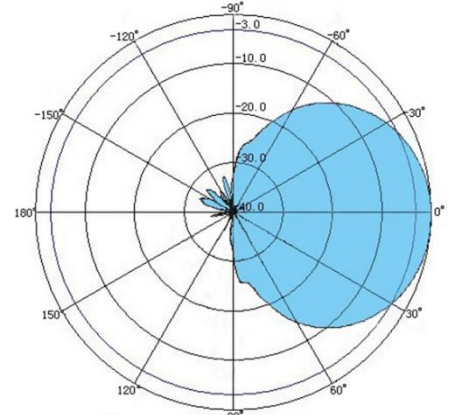

1710-3800MHz

Horizontal

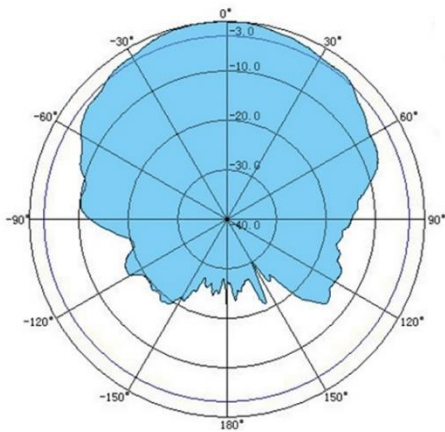

698-960MHz

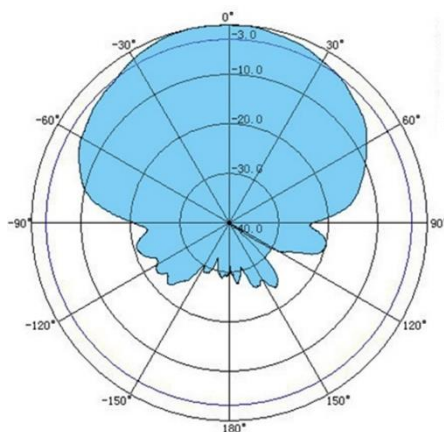

1350-1550MHz

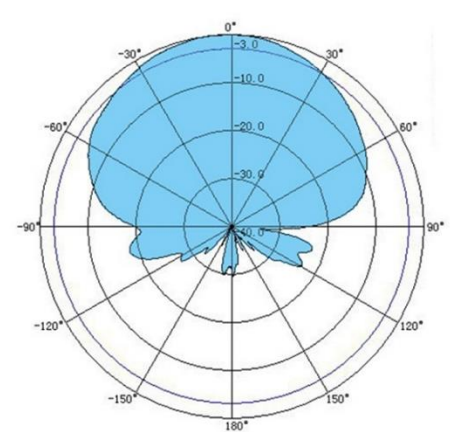

1710-3800MHz

Mechanical Drawing

PD698-3800M2NF

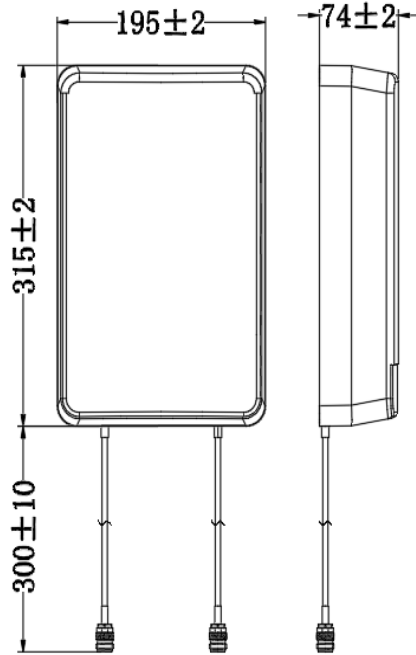

Test Setup

General / Chamber Setup

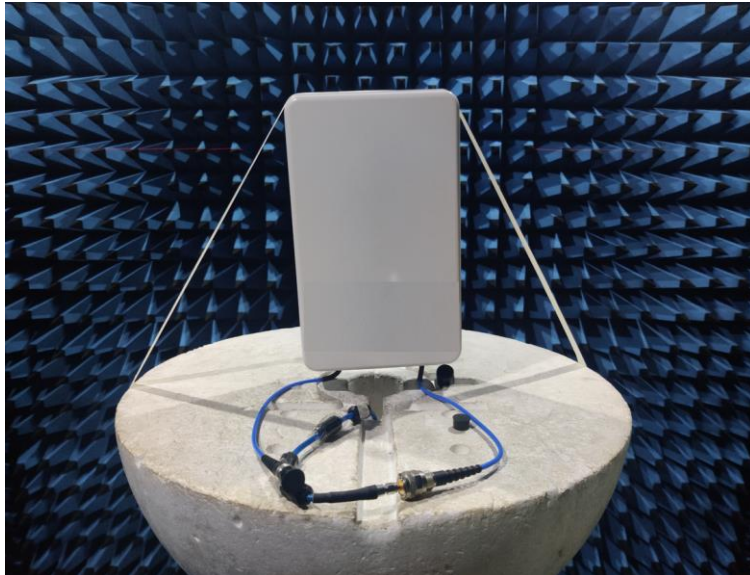

# Directional DAS Series 2xMiMo 4G/5G Antenna + 1350-1550MHz

PD698-3800M2NF

## PACKAGING

### PD698-3800M2NF

1. Inner box: 360\*220\*85mm;
2. Outer box size: 480\*460\*375mm;
3. 10Pcs/Carton;

## Installation instructions

### PD698-3800M2NF

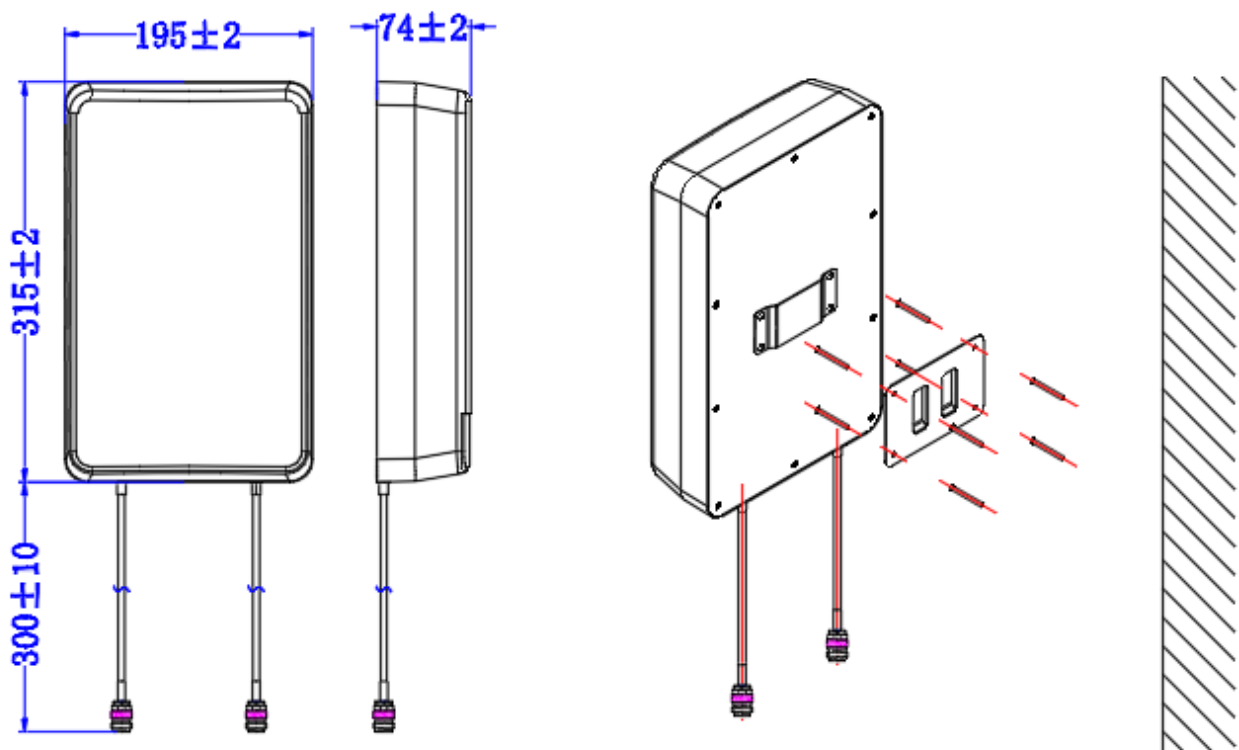

#### Notes:

1. Please contact sales for availability, lead time, and/or any special requests. Samples available upon request.

#### For More Information:

Americas - [antennas.us@pulseelectronics.com](mailto:antennas.us@pulseelectronics.com) | Europe - [antennas.eu@pulseelectronics.com](mailto:antennas.eu@pulseelectronics.com) | Asia - [antennas.as@pulseelectronics.com](mailto:antennas.as@pulseelectronics.com) | Questions? +1-800-ANTENNA  
Performance warranty of products offered on this data sheet is limited to the parameters specified. Data is subject to change without notice. Other brand and product names mentioned herein may be trademarks or registered trademarks of their respective owners. © Copyright , 2020. Pulse Electronics, Inc. All rights reserved.  
Company address: Pulse Electronics, a YAGEO Company, 15255 Innovation Drive, Suite #100, San Diego, CA 92128.

***'YAGEO Corporation and its affiliates do not recommend the use of commercial, automotive, and/or COTS grade products for high reliability applications or manned space flight.'***