

Surface Mount Slic Package Common Mode Chokes

Suited for LAN and Telecom WAN Applications



- Ⓢ Pulse Patented SLIC SMD LPC package
- Ⓢ Reduces radiated EMI emissions
- Ⓢ Filters common mode noise for EMI reduction
- Ⓢ Common mode attenuation from 100 KHz to 1 GHz
- Ⓢ RoHS peak reflow solder temperature 245°C

Electrical Specifications @ 25°C

Part Number ¹	No. of Lines	Primary Inductance OCL (μH MIN)	Common Mode Attenuation (dB TYP)									DCR (Ω MAX)	Primary Application
			100 KHz	1 MHz	10 MHz	30 MHz	50 MHz	100 MHz	300 MHz	500 MHz	1 GHz		
PE-68624NL	2	47	11	27	40	44	42	36	26	17	—	0.40	WAN
B4003NL	2	4700	46	41	48	38	33	21	22	23	17	1.00	VDSL
R0003NL	3	20	6	14	27	27	30	30	30	28	25	0.40	LAN
PE-65627NL	4	24	8	21	32	36	37	36	30	20	—	0.25	WAN
PE-65854NL	4	47	3	19	32	36	35	29	12	6	—	0.40	WAN

- For Tape & Reel packaging, add suffix "T" to the end of the part number e.g. R0003NLT
- MSL = Moisture Sensitivity Level = 1

MECHANICALS

SCHEMATICS

PE-68624NL, R0003NL

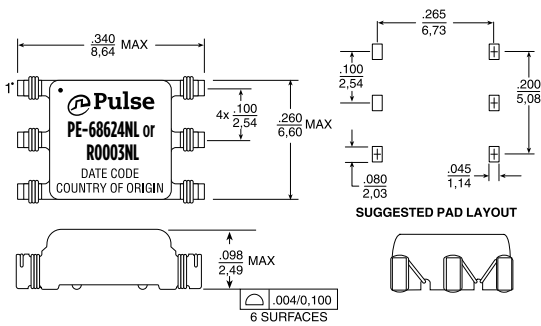

Dimensions: Inches
mm
Unless otherwise specified,
all tolerances are ± .010
0,25

Weight 0.17 grams
Tape & Reel 1500/reel
Tube 85/tube

R0003NL



Connect unused pin to logic ground for optimum performance.

PE-68624NL



B4003NL

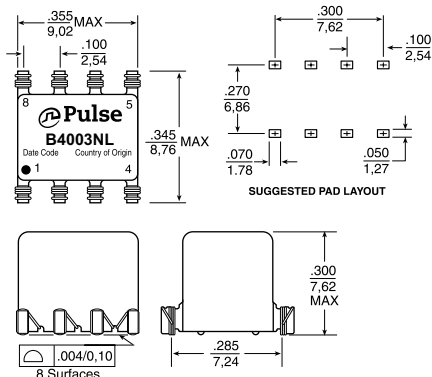

Dimensions: Inches
mm
Unless otherwise specified,
all tolerances are ± .010
0,25

Weight 0.70 grams
Tape & Reel 400/reel
Tube 50/tube

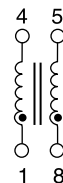

Surface Mount Slic Package Common Mode Chokes

Suited for LAN and Telecom WAN Applications

MECHANICALS

SCHEMATICS

PE-68627NL

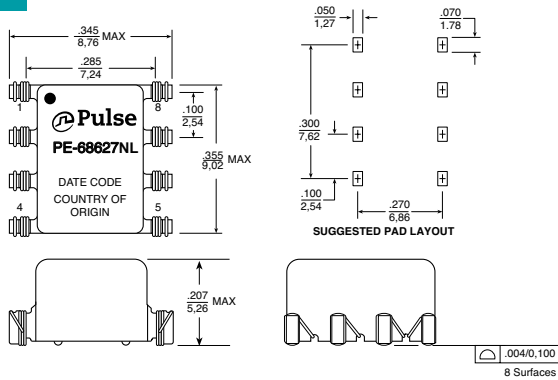

Dimensions: $\frac{\text{Inches}}{\text{mm}}$
Unless otherwise specified,
all tolerances are $\pm \frac{.010}{0.25}$

Weight 0.32 grams
Tape & Reel850/reel
Tube45/tube

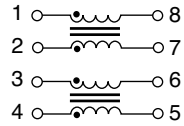

PE-65854NL

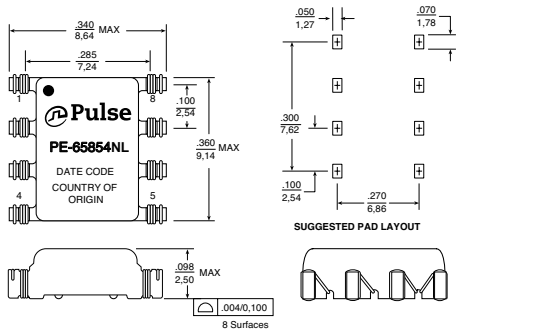

Dimensions: $\frac{\text{Inches}}{\text{mm}}$
Unless otherwise specified,
all tolerances are $\pm \frac{.010}{0.25}$

Weight 0.23 grams
Tape & Reel1500/reel
Tube60/tube

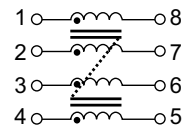

COMMON MODE TEST CIRCUIT FOR SURFACE MOUNT AND THROUGH HOLE

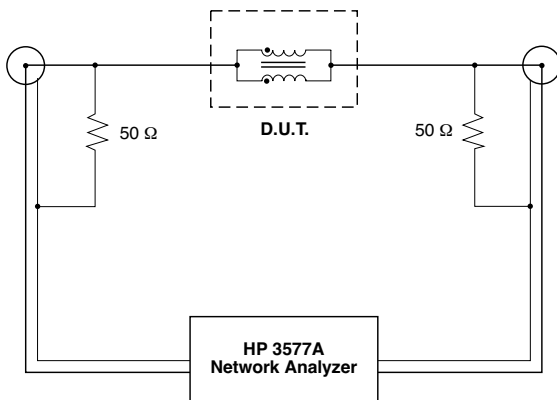

Test Notes:

1. Network analyzer calibrated to compensate for 50 Ω resistors.
2. All windings on a core are connected in parallel for the test.
3. For multi-core chokes, test data is for one core only. The windings on the other core(s) are left unconnected (i.e. open).

For More Information:

Americas - prodinfornetworkamericas@yageo.com | Europe - prodinfornetworkemea@yageo.com | Asia - prodinfornetworkapac@yageo.com

Performance warranty of products offered on this data sheet is limited to the parameters specified. Data is subject to change without notice. Other brand and product names mentioned herein may be trademarks or registered trademarks of their respective owners. © Copyright, 2022. Pulse Electronics, Inc. All rights reserved.