

MULTI BAND SWIVEL MOUNT DIPOLE
698-960/1710-2170/2500-2700MHz

SPDA24700/2700

Series : ANTENNA

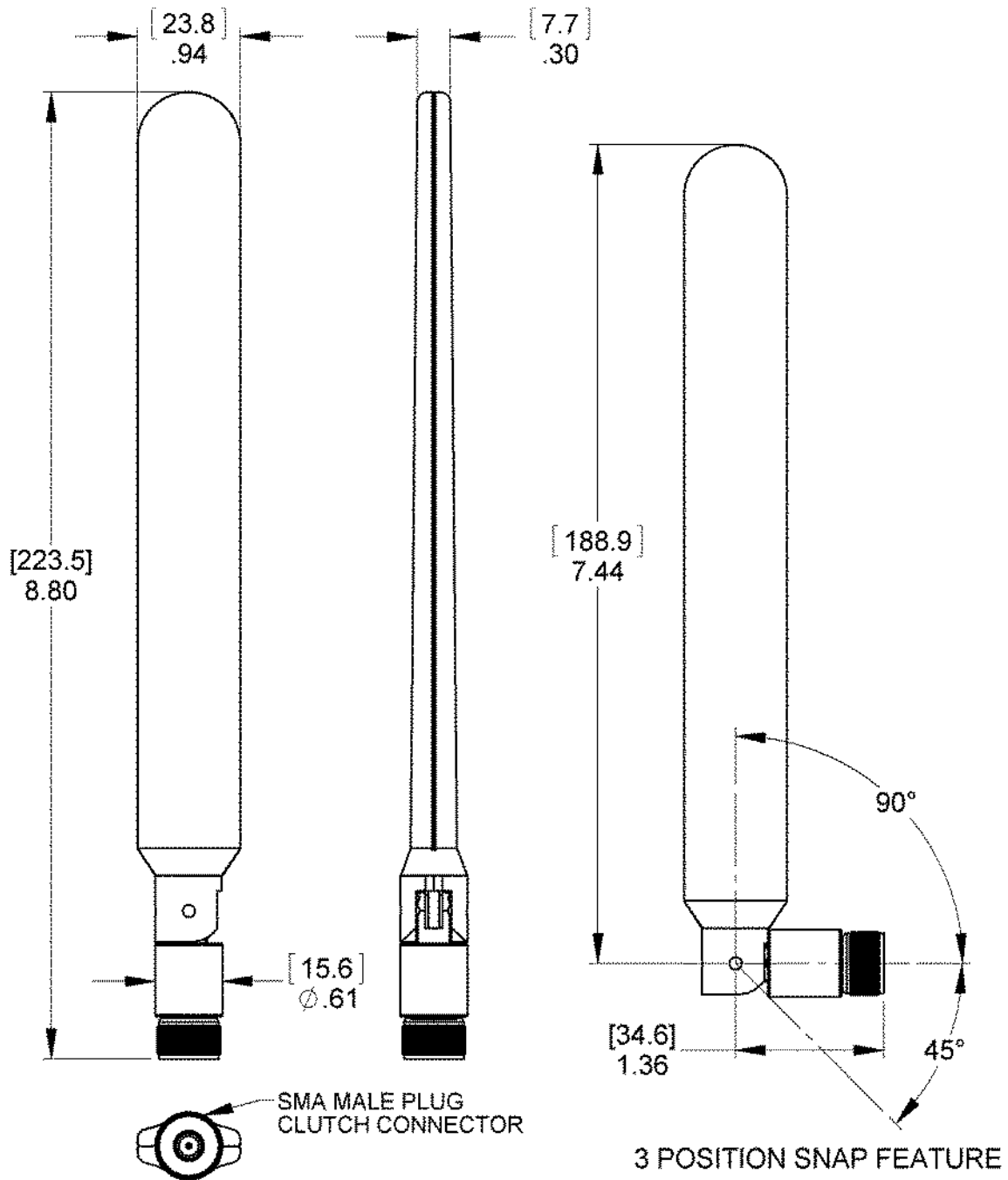

All dimensions are in inches (mm)

Issue: 1317

In the effort to improve our products, we reserve the right to make changes judged to be necessary.

CONFIDENTIAL AND PROPRIETARY INFORMATION

This document contains confidential and proprietary information of Pulse Electronics, Inc. (Pulse) and is protected by copyright, trade secret and other state and federal laws. Its receipt or possession does not convey any rights to reproduce, disclose its contents, or to manufacture, use or sell anything it may describe. Reproduction, disclosure or use without specific written authorization of Pulse is strictly forbidden

MULTI BAND SWIVEL MOUNT DIPOLE
698-960/1710-2170/2500-2700MHz

SPDA24700/2700
 Series : **ANTENNA**

ELECTRICAL SPECIFICATIONS

Antenna type	Dipole (All electrical performance measured "in free space")
Frequency	698-960/1710-2170/2500-2700 MHz
Nominal Impedance	50 Ω
VSWR	2.5:1 Max
Average Peak Gain 700	0.6 dBi
Average Peak Gain 1710	1.5 dBi
Average Peak Gain 2500	3.4 dBi
Efficiency	60 % TYP
HPBW / Horizontal Plane	Omni
HPBW / Vertical Plane 700	57 ° TYP
HPBW / Vertical Plane 1710	54 ° TYP
HPBW / Vertical Plane 2500	36 ° TYP
Polarization:	Vertical
Power withstanding	3 W
Connector type	SMA-Male (Clutch style)

MECHANICAL SPECIFICATIONS

Plastic radome	PC/ABS
Color	Black
Flammability (Radome)	UL94 V-O
Weight	45.4 g
Positions	0°, 45° & 90°
Overall length	8.8 INCHES

ENVIRONMENTAL SPECIFICATIONS

Operating temperature	-30/+70 ° C
Storage Temperature	-40/+85 ° C

Issue: 1317

In the effort to improve our products, we reserve the right to make changes judged to be necessary.

CONFIDENTIAL AND PROPRIETARY INFORMATION

This document contains confidential and proprietary information of Pulse Electronics, Inc. (Pulse) and is protected by copyright, trade secret and other state and federal laws. Its receipt or possession does not convey any rights to reproduce, disclose its contents, or to manufacture, use or sell anything it may describe. Reproduction, disclosure or use without specific written authorization of Pulse is strictly forbidden



MULTI BAND SWIVEL MOUNT DIPOLE
698-960/1710-2170/2500-2700MHz

SPDA24700/2700

Series : ANTENNA

Charts

Vertical plane

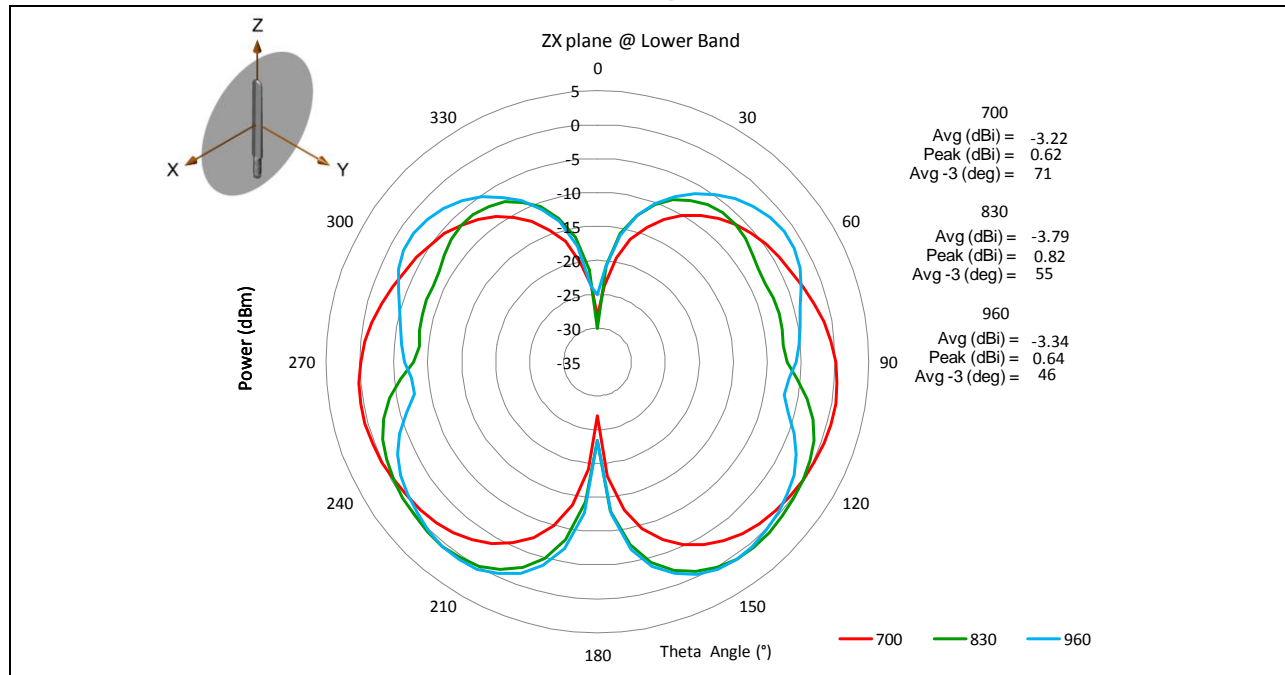

Vertical plane

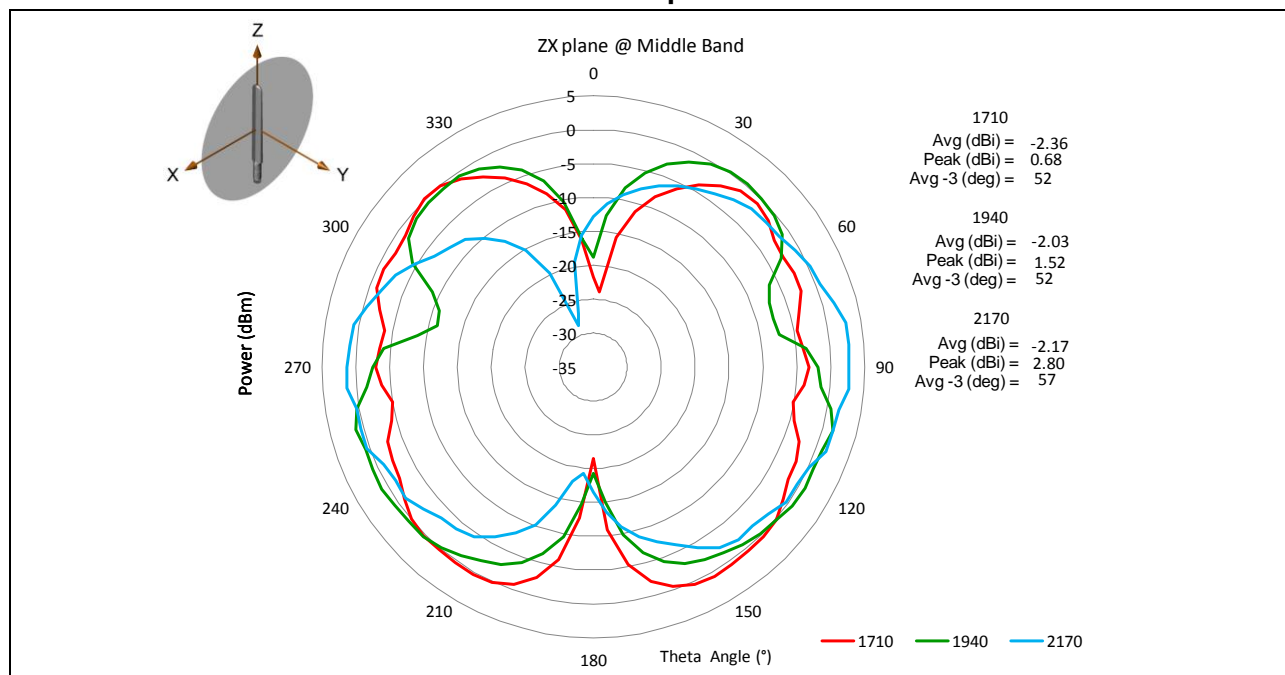

Issue: 1317

In the effort to improve our products, we reserve the right to make changes judged to be necessary.

CONFIDENTIAL AND PROPRIETARY INFORMATION

This document contains confidential and proprietary information of Pulse Electronics, Inc. (Pulse) and is protected by copyright, trade secret and other state and federal laws. Its receipt or possession does not convey any rights to reproduce, disclose its contents, or to manufacture, use or sell anything it may describe. Reproduction, disclosure or use without specific written authorization of Pulse is strictly forbidden



MULTI BAND SWIVEL MOUNT DIPOLE
698-960/1710-2170/2500-2700MHz

SPDA24700/2700

Series : ANTENNA

Vertical plane

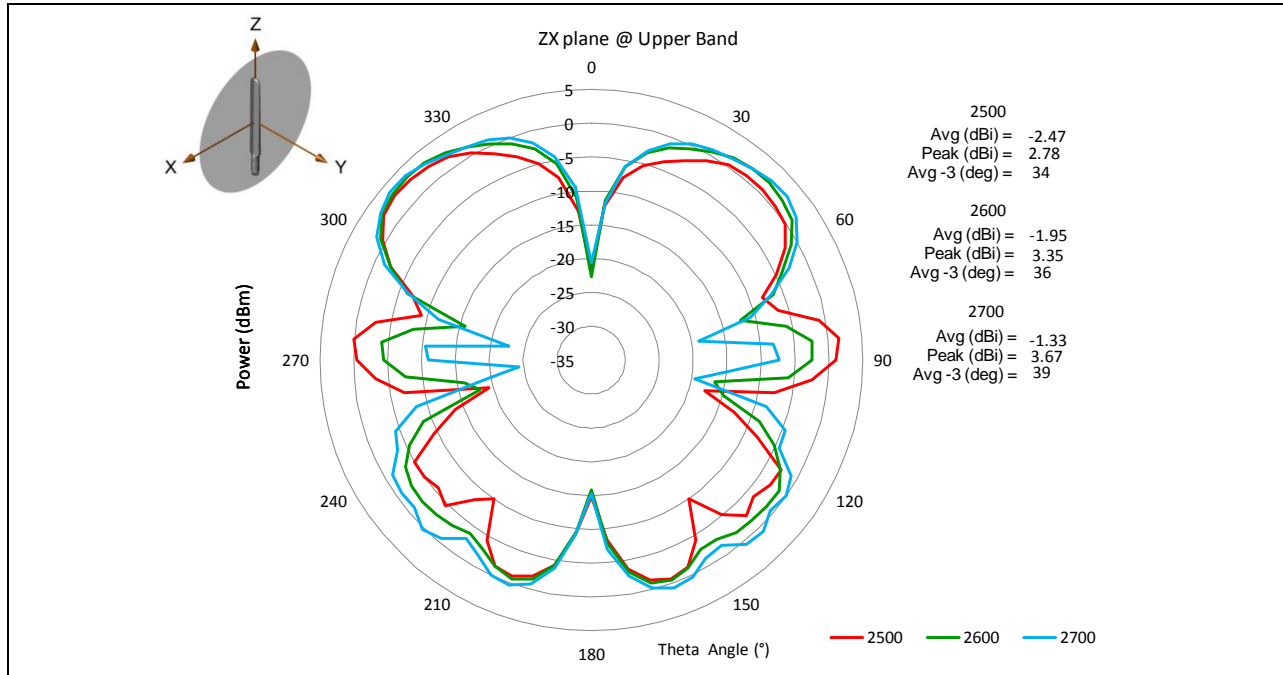

Horizontal plane

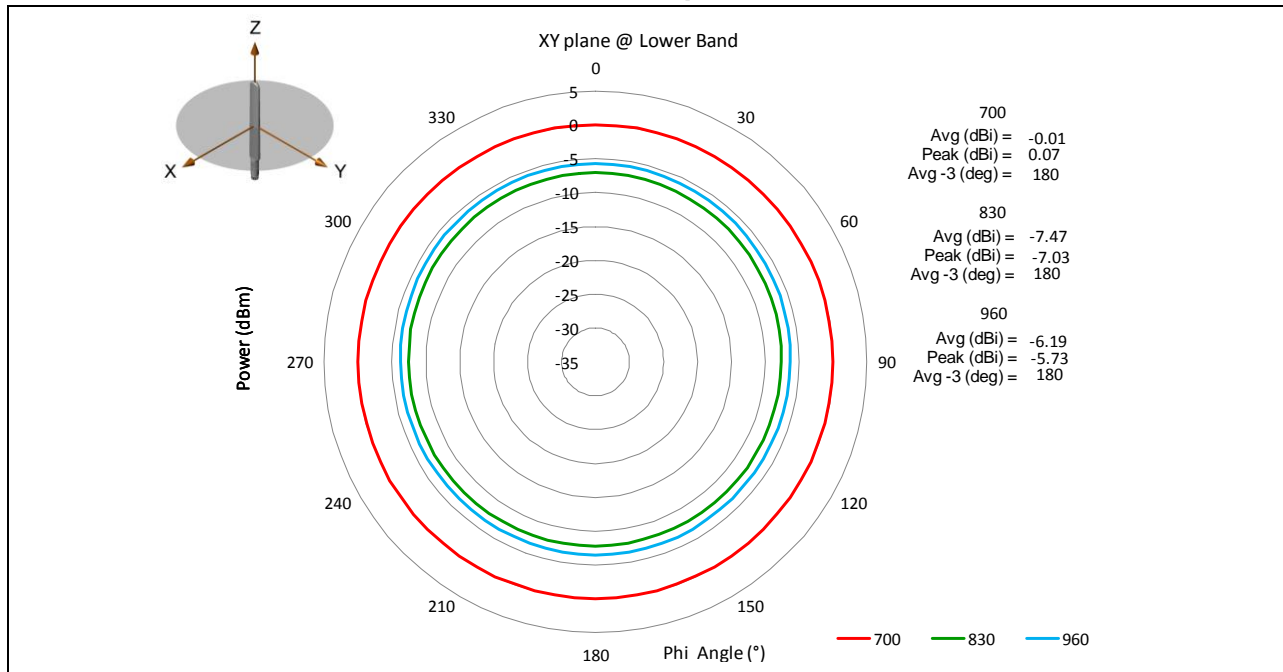

Issue: 1317

In the effort to improve our products, we reserve the right to make changes judged to be necessary.

CONFIDENTIAL AND PROPRIETARY INFORMATION

This document contains confidential and proprietary information of Pulse Electronics, Inc. (Pulse) and is protected by copyright, trade secret and other state and federal laws. Its receipt or possession does not convey any rights to reproduce, disclose its contents, or to manufacture, use or sell anything it may describe. Reproduction, disclosure or use without specific written authorization of Pulse is strictly forbidden



MULTI BAND SWIVEL MOUNT DIPOLE
698-960/1710-2170/2500-2700MHz

SPDA24700/2700

Series : ANTENNA

Horizontal plane

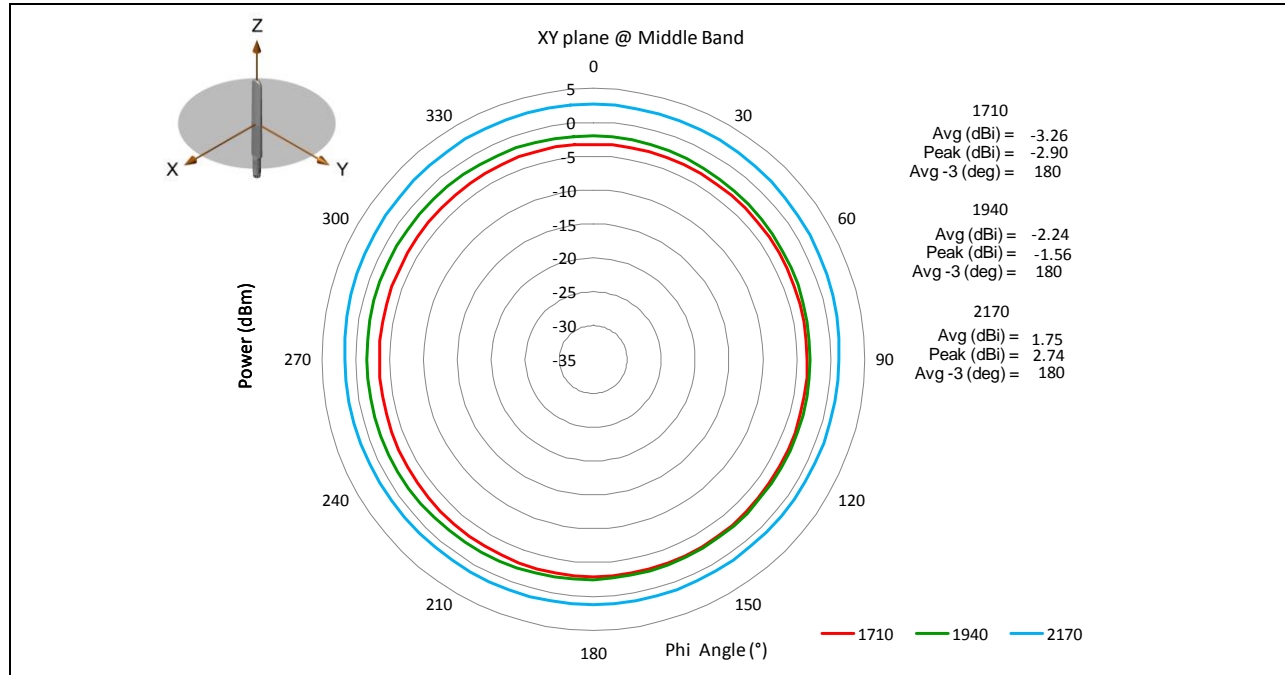

Horizontal plane

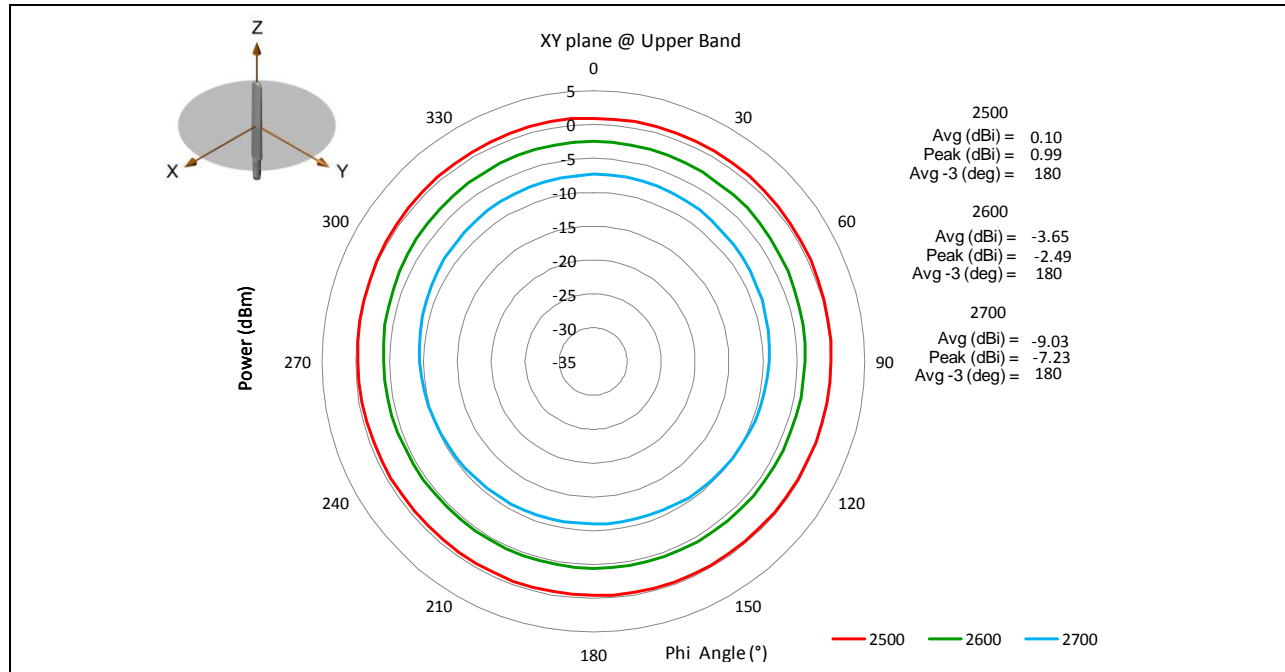

Issue: 1317

In the effort to improve our products, we reserve the right to make changes judged to be necessary.

CONFIDENTIAL AND PROPRIETARY INFORMATION

This document contains confidential and proprietary information of Pulse Electronics, Inc. (Pulse) and is protected by copyright, trade secret and other state and federal laws. Its receipt or possession does not convey any rights to reproduce, disclose its contents, or to manufacture, use or sell anything it may describe. Reproduction, disclosure or use without specific written authorization of Pulse is strictly forbidden



MULTI BAND SWIVEL MOUNT DIPOLE
698-960/1710-2170/2500-2700MHz

SPDA24700/2700

Series : ANTENNA

VSWR

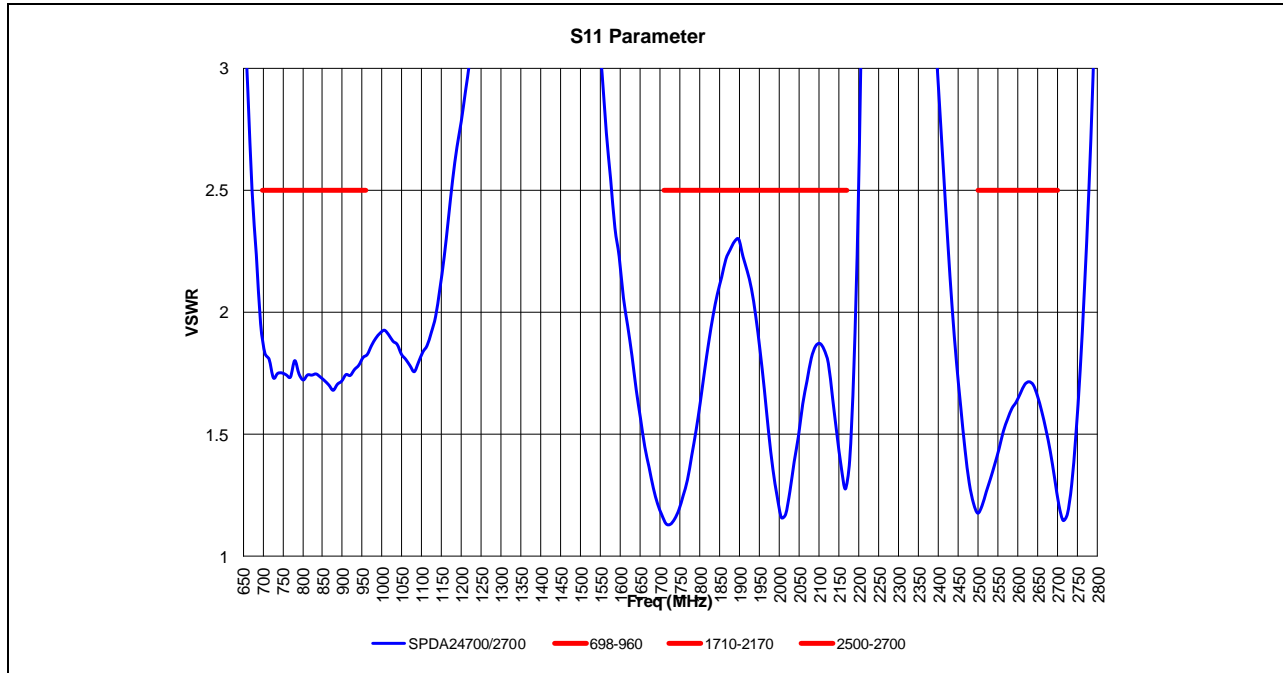

Peak Gain

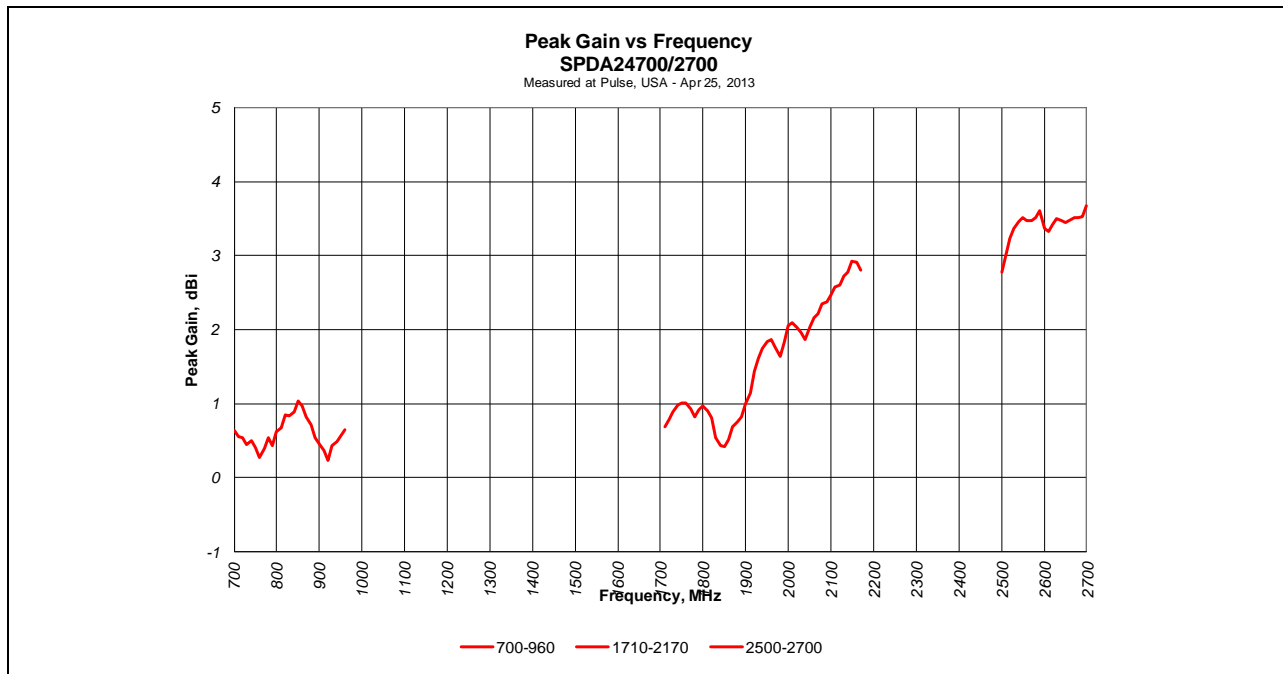

Issue: 1317

In the effort to improve our products, we reserve the right to make changes judged to be necessary.

CONFIDENTIAL AND PROPRIETARY INFORMATION

This document contains confidential and proprietary information of Pulse Electronics, Inc. (Pulse) and is protected by copyright, trade secret and other state and federal laws. Its receipt or possession does not convey any rights to reproduce, disclose its contents, or to manufacture, use or sell anything it may describe. Reproduction, disclosure or use without specific written authorization of Pulse is strictly forbidden



MULTI BAND SWIVEL MOUNT DIPOLE
698-960/1710-2170/2500-2700MHz

SPDA24700/2700

Series : ANTENNA

Efficiency

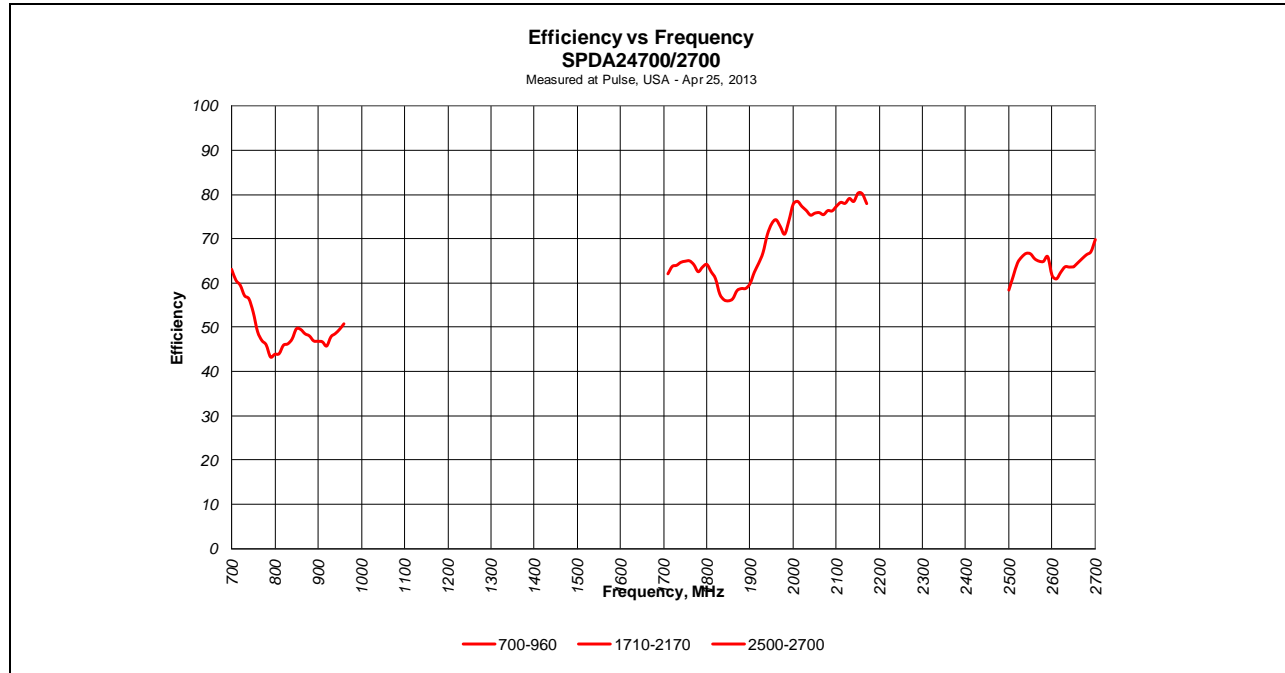

Issue: 1317

In the effort to improve our products, we reserve the right to make changes judged to be necessary.

CONFIDENTIAL AND PROPRIETARY INFORMATION

This document contains confidential and proprietary information of Pulse Electronics, Inc. (Pulse) and is protected by copyright, trade secret and other state and federal laws. Its receipt or possession does not convey any rights to reproduce, disclose its contents, or to manufacture, use or sell anything it may describe. Reproduction, disclosure or use without specific written authorization of Pulse is strictly forbidden

