











5G-FR1 Multiband Flat 2x2 MiMo Antenna

W1856 – 617MHz to 7125MHz



Features & Applications:

-  2xMiMo antenna configuration
-  Omnidirectional radiation
-  Clip mount connections
-  Low profile (thickness 9.6mm/.377")
-  RoHS compliant
-  5G-FR1 Laptop connectivity
-  5G-FR1 Access Point and Routers
-  5G-FR1 Accessories
-  4G LTE Backward compatible
-  WiFi-6E/7 2xMiMo compatible

ELECTRICAL SPECIFICATIONS @ 25°C

General Specifications

Antenna type	Nominal Impedance	Polarization	Radiation pattern	Power withstanding	DC Ground
Dipole	50Ω	Vertical / Linear	Omni	2W	Yes

Typical RF Performance: 617 – 7125MHz

Port	Frequency (MHz)	617 - 960	1710 - 2690	3300 - 4200	4400 - 5150	5150 - 7125
Port 1 & 2	Return Loss (dB)	-6	-6	-7	-7	-5
	Avg. Peak Gain (dBi)	1.6	3.1	4.0	4.8	5.3
	Avg. Efficiency (%)	73	70	65	69	65
	Cable Loss dB	0.8	1.2	1.8	2.2	3.0
Port 1 to 2 Isolation	Port 1-2 (dB)	15	20	25	25	20

MECHANICAL SPECIFICATIONS

Orderable P/N: W1856

Dimension (Length x Width x Height)	Housing Material	Color	Weight	Connector Type	Cable Type Length
159.5 x 127.5 x 9.6 mm (6.28 x 5.02 x 0.377")	PC/ABS	Black	131.5g (1.85lbs)	SMA Male	RG174 1000mm (39.37")

ENVIRONMENTAL SPECIFICATIONS

Operating Temperature	Storage Temperature	Ingress Protection	RoHS Compliant
-40 / +85° C	-40 / +85° C	IP51	Yes

5G-FR1 Multiband Flat 2x2 MiMo Antenna

W1856 – 617MHz to 7125MHz

Mechanical data and RF Test Setup

Drawings

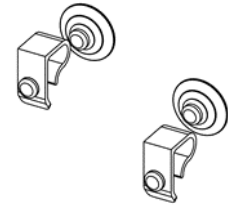
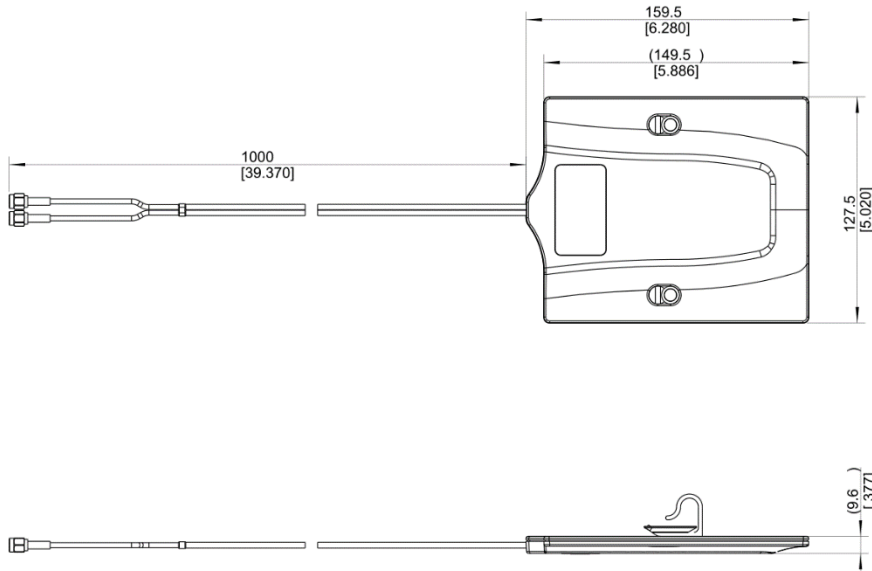

Clips & suction cups

- Dimensions: inches (mm) Unless otherwise specified, all tolerances are ± 0.10 (0.25mm)

RF Test Setup

- S-parameters tested with 1.0 m RG174 cable
- Gain and Efficiency tested with 0.15 m Semirigid cable
- Measured at Pulse Finland in Satimo/MVG SG24L



Charts - Return Loss and Isolation

S-parameter test data

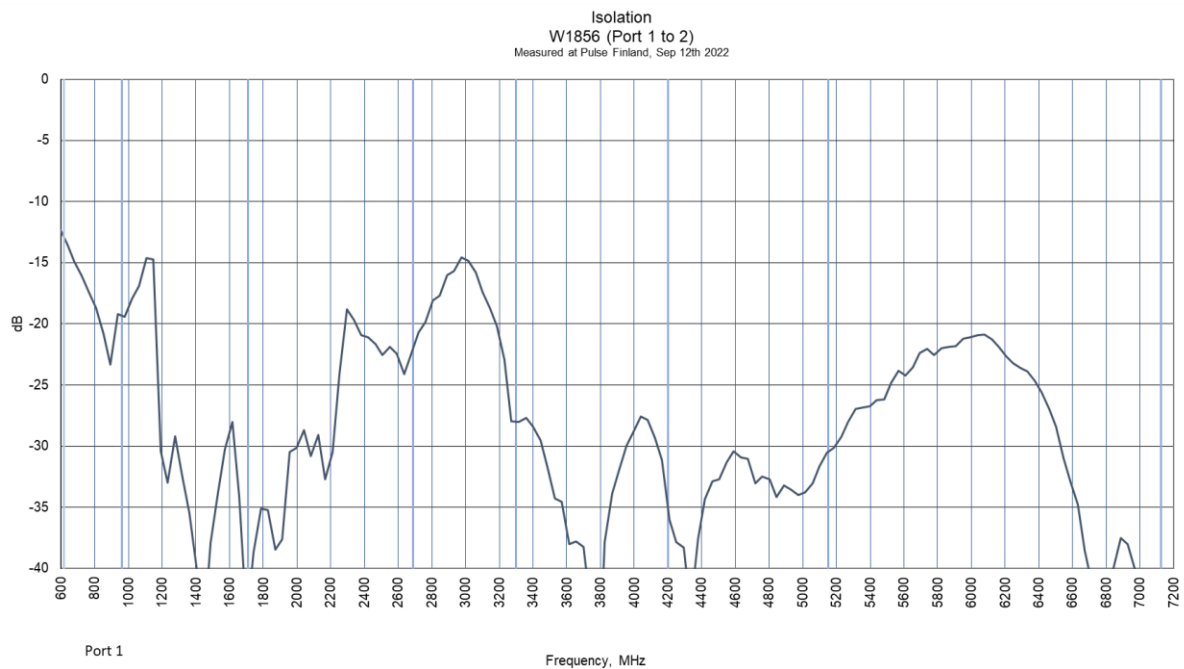
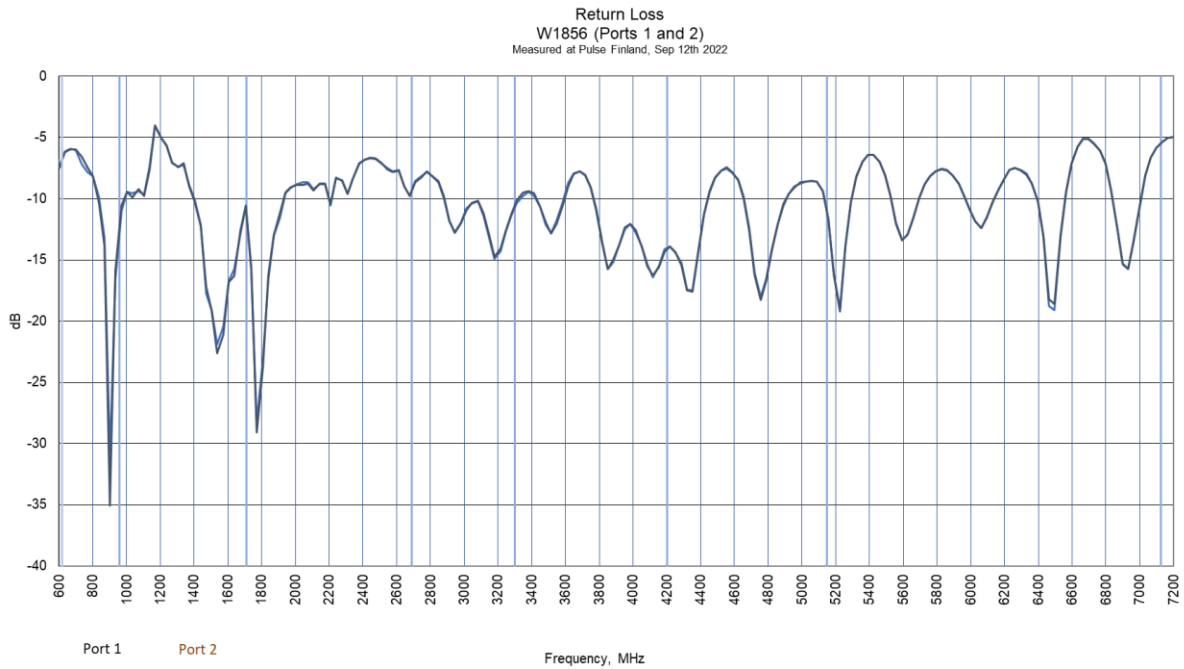

Charts- Efficiency and Max Gain

Chamber test data

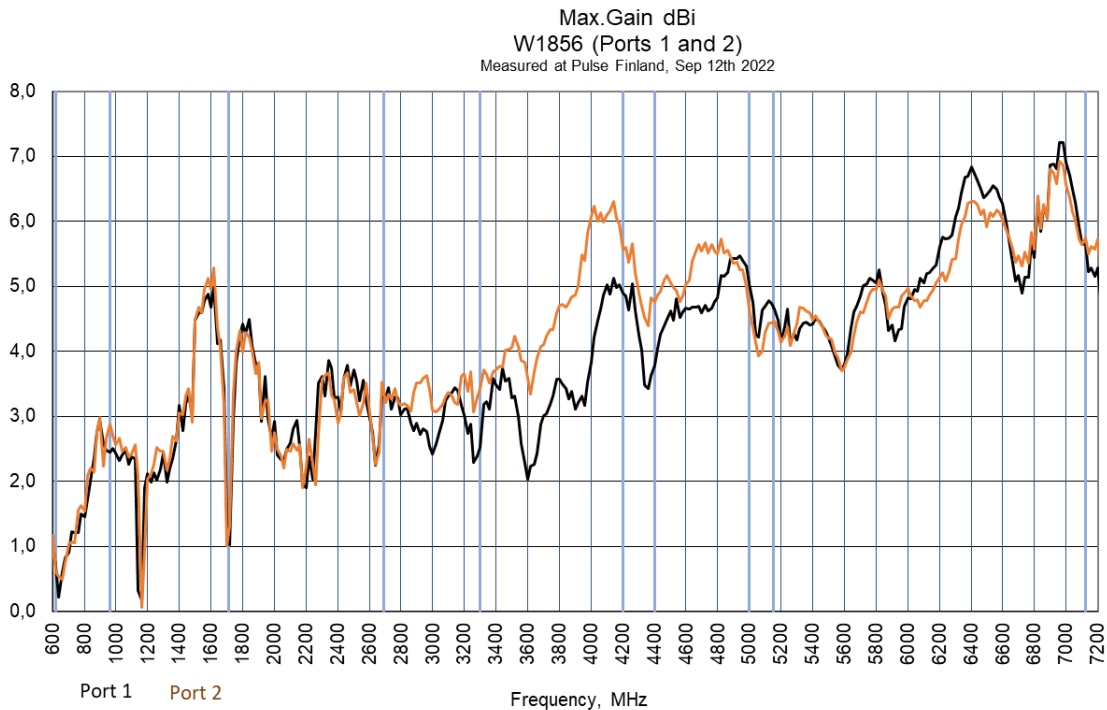
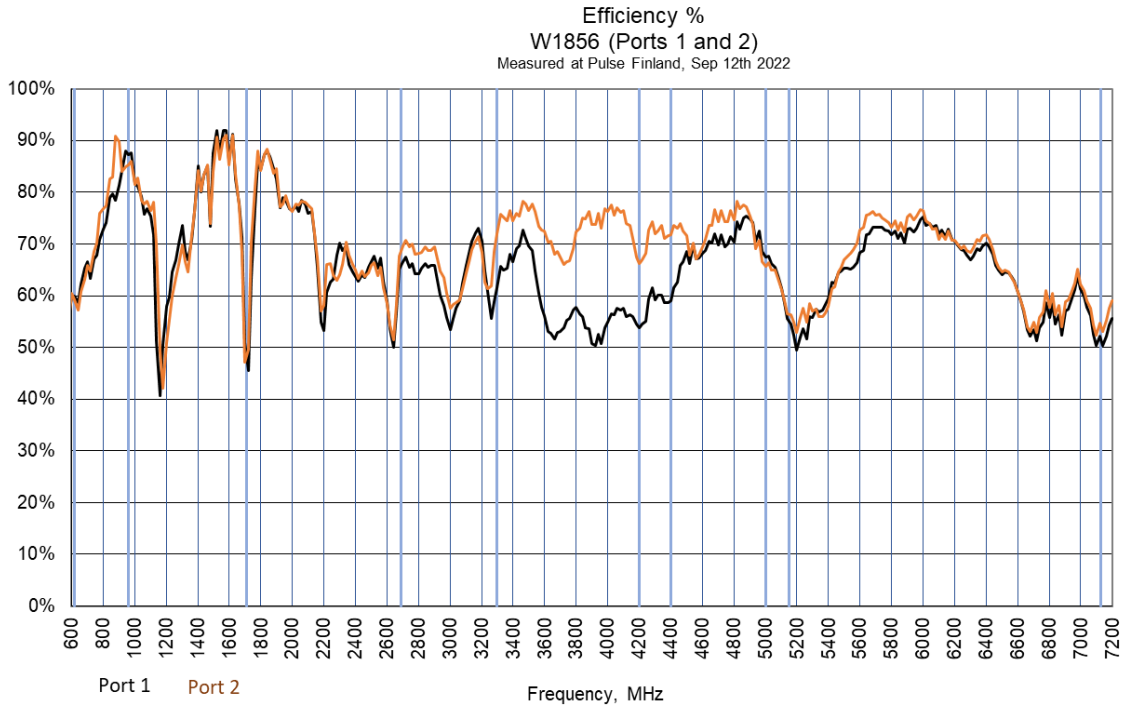

Radiation Pattern – Gain Plots

YZ, ZX, XY Planes

Port 1

Port 2

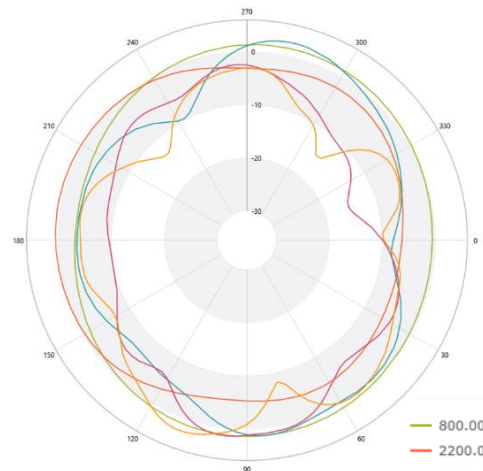
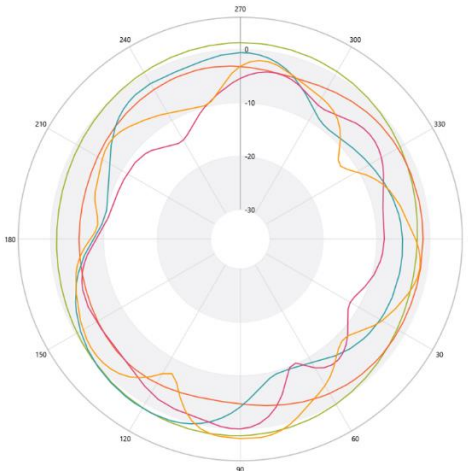
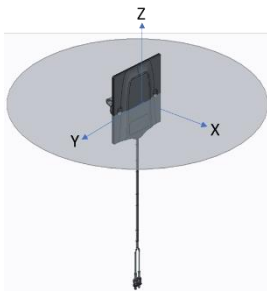
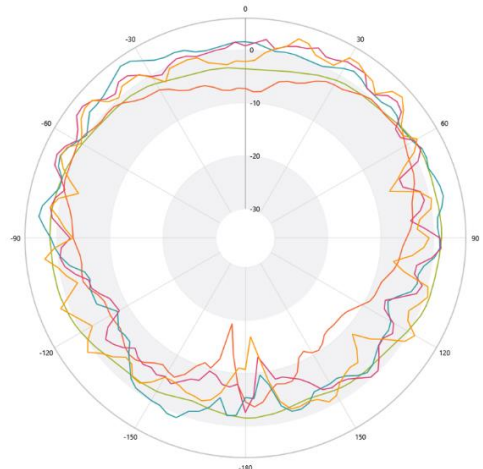
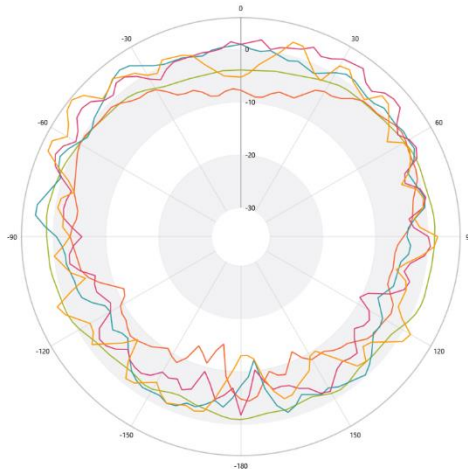
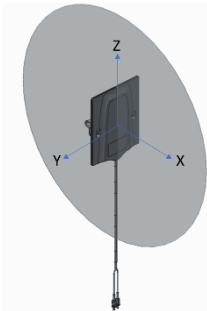
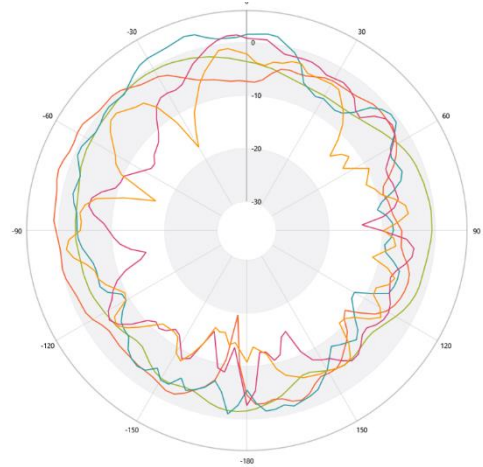
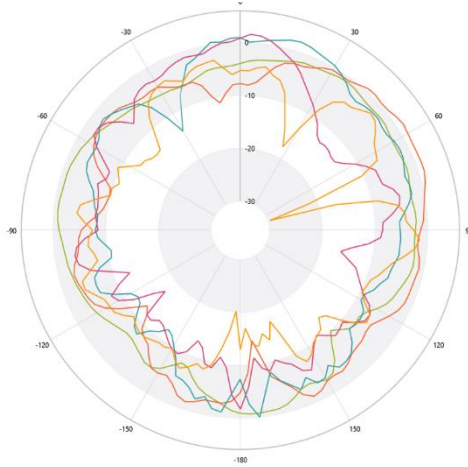
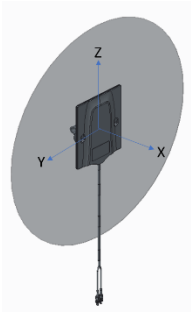

- 800.00 MHz 0.00 ° E Total
- 2200.00 MHz 0.00 ° E Total
- 3800.00 MHz 0.00 ° E Total
- 5160.00 MHz 0.00 ° E Total
- 7120.00 MHz 0.00 ° E Total

5G-FR1 Multiband Flat 2x2 MiMo Antenna

W1856 – 617MHz to 7125MHz

PACKAGING

Packing method

PE bag + Foam bag + Carton box

1pcs/PE bag

5pcs/foam bag

50pcs/carton box

Carton box size: 558mmx382mmx210mm

For More Information:

Americas - antennas.us@pulseelectronics.com | Europe – antennas.eu@pulseelectronics.com | Asia – antennas.as@pulseelectronics.com | [Questions?](#) +1-800-ANTENNA
Performance warranty of products offered on this data sheet is limited to the parameters specified. Data is subject to change without notice. Other brand and product names mentioned herein may be trademarks or registered trademarks of their respective owners. © Copyright , 2020. Pulse Electronics, Inc. All rights reserved.