

Series: Jaguar

Description: 3G/4G LTE 2xMiMo Vehicular Antenna

PART NUMBER: W1919



### Features:

- 698-960/1710-3800MHz
- Extremely compact size LTE MiMo Antenna
  - 78.2 x 78.2 x 30.3mm
- Standard cable length 3m with SMA Male connectors
- IP67
- Mounting with adhesive tape

### Applications:

- Indoor and outdoor use
- 2G/3G/4G radios
- 2xLTE MiMo
- 3G Main + Diversity
- Vehicular, Telematics, Transportation
- Cellular access points

All dimensions are in mm / inches

Issue:1915

In the effort to improve our products, we reserve the right to make changes judged to be necessary.

CONFIDENTIAL AND PROPRIETARY INFORMATION

This document contains confidential and proprietary information of Pulse Electronics, Inc. (Pulse) and is protected by copyright, trade secret and other state and federal laws. Its receipt or possession does not convey any rights to reproduce, disclose its contents, or to manufacture, use or sell anything it may describe. Reproduction, disclosure or use without specific written authorization of Pulse is strictly forbidden.

For more information:

Pulse Worldwide Headquarters  
15255 Innovation Drive #100  
San Diego, CA 92128  
USA  
Tel:1-858-674-8100

Pulse/Larsen Antennas  
18110 SE 34<sup>th</sup> St Bldg 2 Suite 250  
Vancouver, WA 98683  
USA  
Tel: 1-360-944-7551

Europe Headquarters  
Pulse GmbH & Do, KG  
Zeppelinstrasse 15  
Herrenberg, Germany  
Tel: 49 7032 7806 0

Pulse (Suzhou) Wireless Products Co, Inc.  
99 Huo Ju Road(#29 Bldg,4<sup>th</sup> Phase  
Suzhou New District  
Jiangsu Province, Suzhou 215009 PR China  
Tel: 86 512 6807 9998



**Description:** 3G/4G LTE 2xMiMo Vehicular Antenna

**Series:** Jaguar

**PART NUMBER:** W1919

**ELECTRICAL SPECIFICATIONS**

Frequency	698-960 MHz / 1710-2690MHz/3400-3800MHz
Nominal Impedance	50 Ω
Return Loss	-10 dB
Isolation	-15 dB
Radiation Pattern	Omni
Gain	-0.42dBi @698-960MHz 1.77dBi @1710-2690MHz 1.76dBi @3400-3800MHz
Polarization	Vertical
Power Withstanding	5W

**MECHANICAL SPECIFICATIONS**

Overall Length	78.2mm
Weight	142g
Antenna Color / Material	Black, PC
Connector type	SMA Male
Cable type	RG174, Black
Cable length	3000mm

**ENVIRONMENTAL SPECIFICATIONS**

Operating Temperature	-40 ~ +85° C
Storage Temperature	-40 ~ +85° C
Ingress Protection	IP67
RoHS Compliant	Yes

Issue: 1915

In the effort to improve our products, we reserve the right to make changes judged to be necessary.

CONFIDENTIAL AND PROPRIETARY INFORMATION

This document contains confidential and proprietary information of Pulse Electronics, Inc. (Pulse) and is protected by copyright, trade secret and other state and federal laws. Its receipt or possession does not convey any rights to reproduce, disclose its contents, or to manufacture, use or sell anything it may describe. Reproduction, disclosure or use without specific written authorization of Pulse is strictly forbidden.

Description: 3G/4G LTE 2xMiMo Vehicular Antenna

Series: Jaguar

PART NUMBER: W1919

MECHANICAL DRAWING

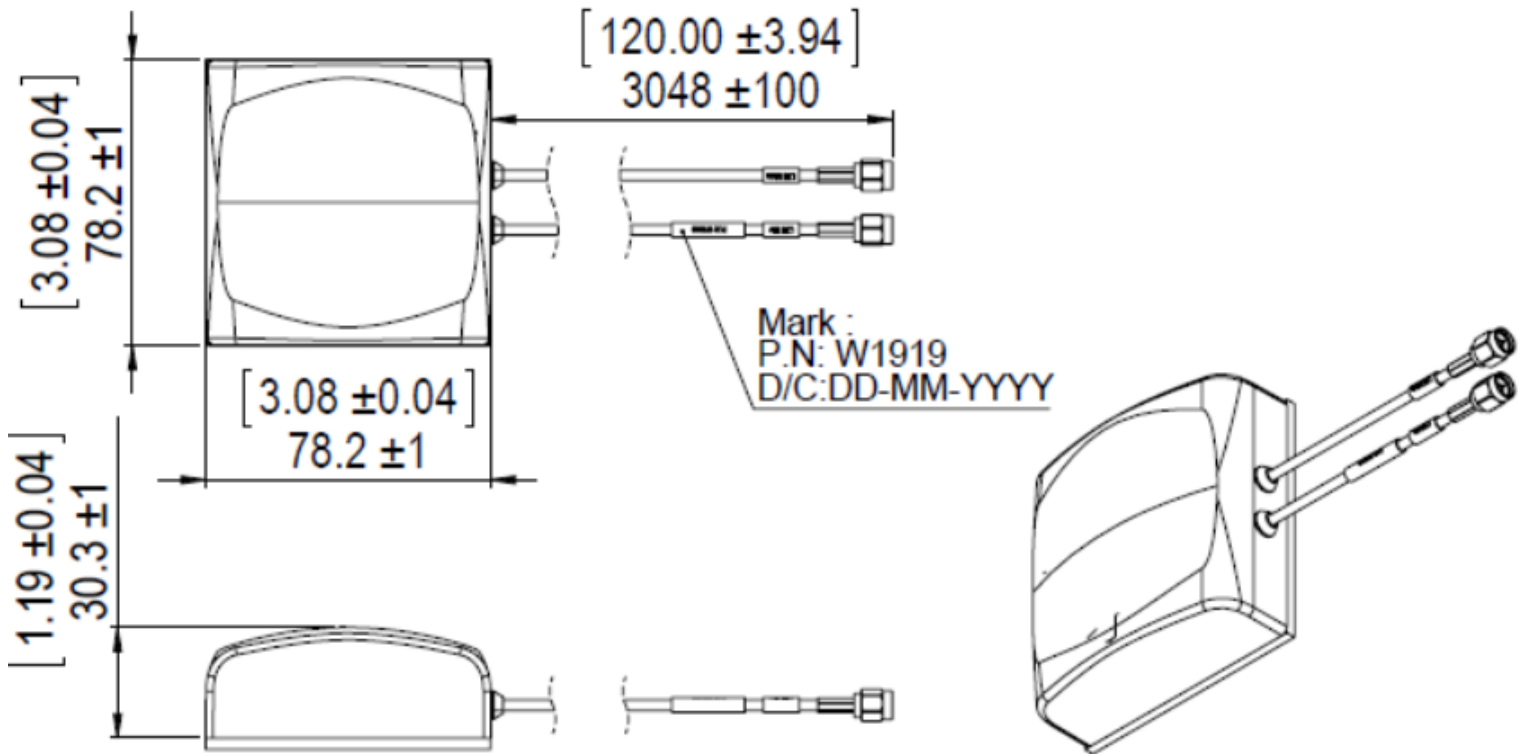

Part NO.	CABLE LENGTH	LTE Main Cable	LTE Div Cable	APPEARANCE COLOR	MOUNTING
W1919	3M(118.11")	RG174+SMA Male	RG174+SMA Male	Black	Adhesive Mount

Issue: 1915

In the effort to improve our products, we reserve the right to make changes judged to be necessary.

CONFIDENTIAL AND PROPRIETARY INFORMATION

This document contains confidential and proprietary information of Pulse Electronics, Inc. (Pulse) and is protected by copyright, trade secret and other state and federal laws. Its receipt or possession does not convey any rights to reproduce, disclose its contents, or to manufacture, use or sell anything it may describe. Reproduction, disclosure or use without specific written authorization of Pulse is strictly forbidden.

**Description:** 3G/4G LTE 2xMiMo Vehicular Antenna

**Series:** Jaguar

**PART NUMBER:** W1919

**CHARTS**

Return Loss

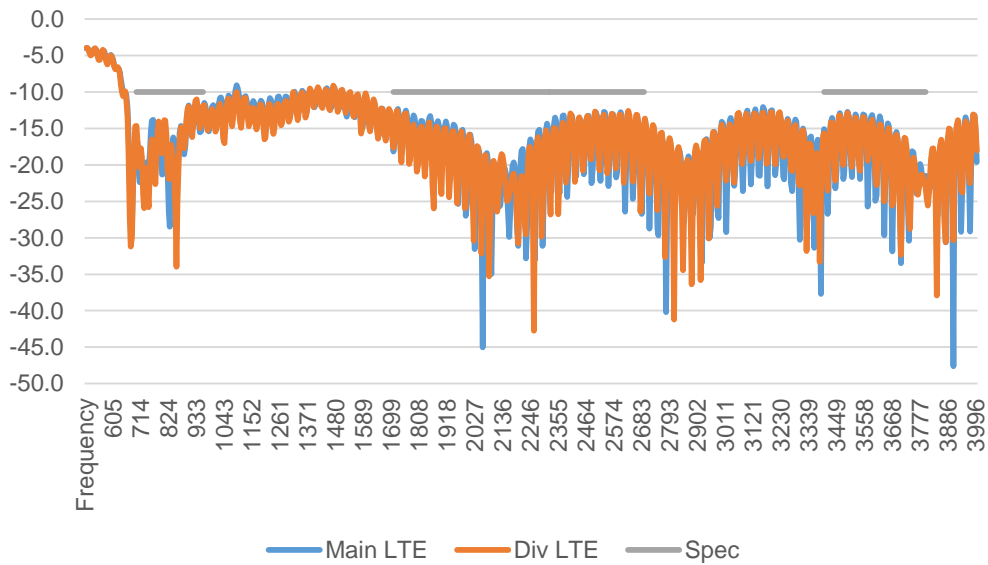

Isolation

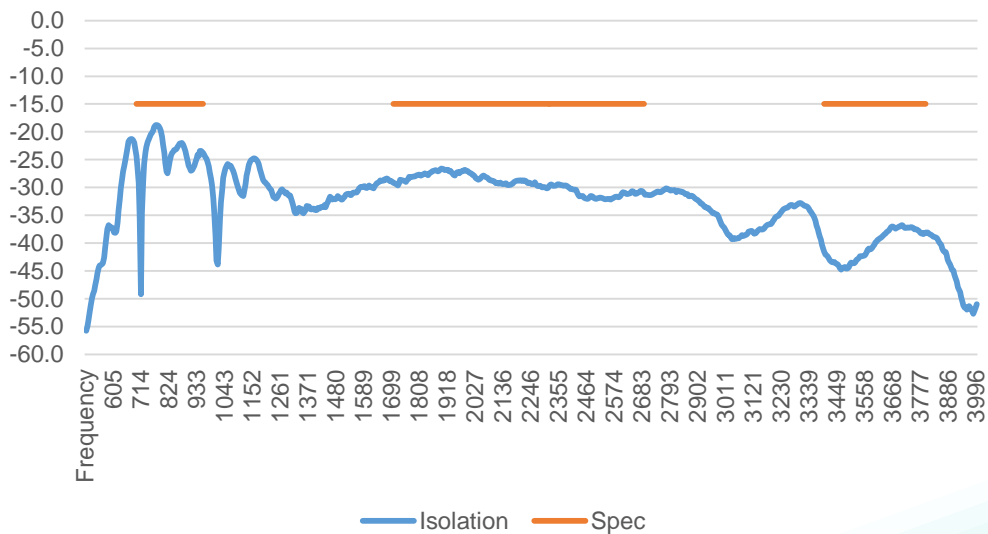

Note : Antenna measured with 10ft cable

Issue: 1915

In the effort to improve our products, we reserve the right to make changes judged to be necessary.

CONFIDENTIAL AND PROPRIETARY INFORMATION

This document contains confidential and proprietary information of Pulse Electronics, Inc. (Pulse) and is protected by copyright, trade secret and other state and federal laws. Its receipt or possession does not convey any rights to reproduce, disclose its contents, or to manufacture, use or sell anything it may describe. Reproduction, disclosure or use without specific written authorization of Pulse is strictly forbidden.

**Description:** 3G/4G LTE 2xMiMo Vehicular Antenna

**Series:** Jaguar

**PART NUMBER:** W1919

**CHARTS**

Efficiency(%)

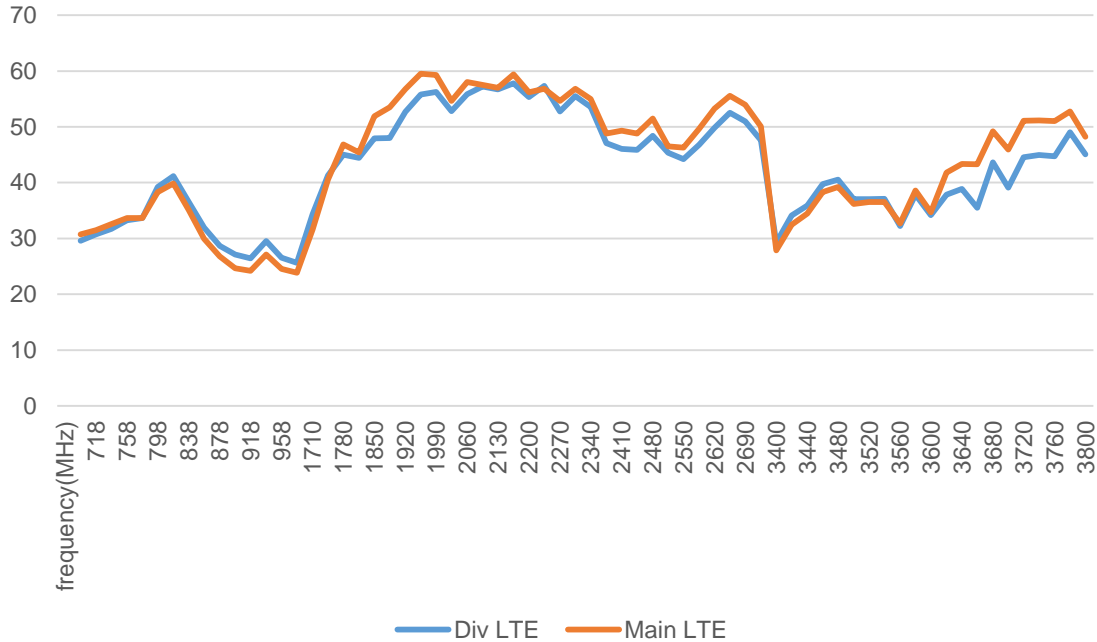

Peak Gain(dBi)

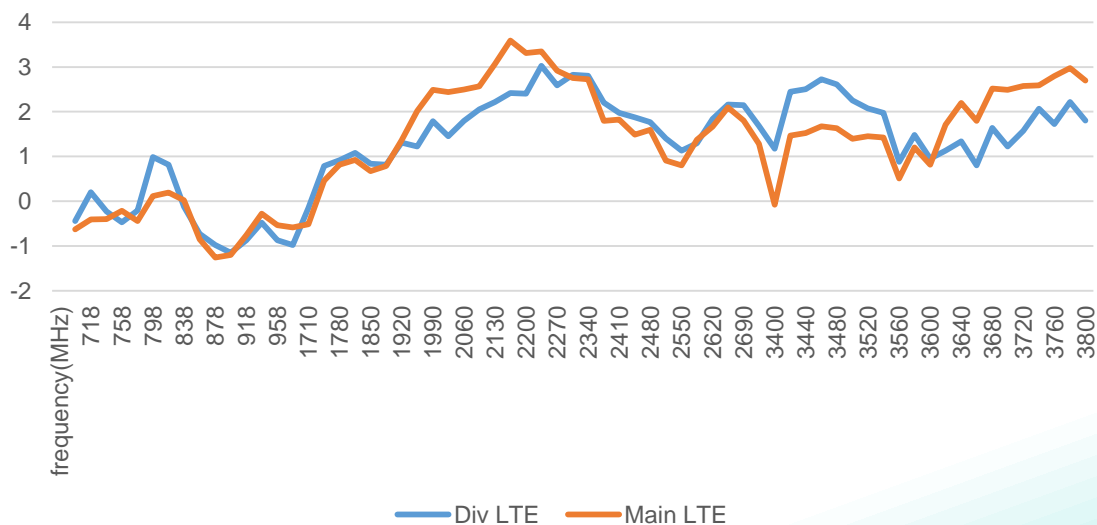

Note : Antenna measured in free space with 150mm cable

Issue: 1915

In the effort to improve our products, we reserve the right to make changes judged to be necessary.

CONFIDENTIAL AND PROPRIETARY INFORMATION

This document contains confidential and proprietary information of Pulse Electronics, Inc. (Pulse) and is protected by copyright, trade secret and other state and federal laws. Its receipt or possession does not convey any rights to reproduce, disclose its contents, or to manufacture, use or sell anything it may describe. Reproduction, disclosure or use without specific written authorization of Pulse is strictly forbidden.

**Description:** 3G/4G LTE 2xMiMo Vehicular Antenna

**Series:** Jaguar

**PART NUMBER:** W1919

**CHARTS**

**Gain Plots (Main LTE)**

XY Plane

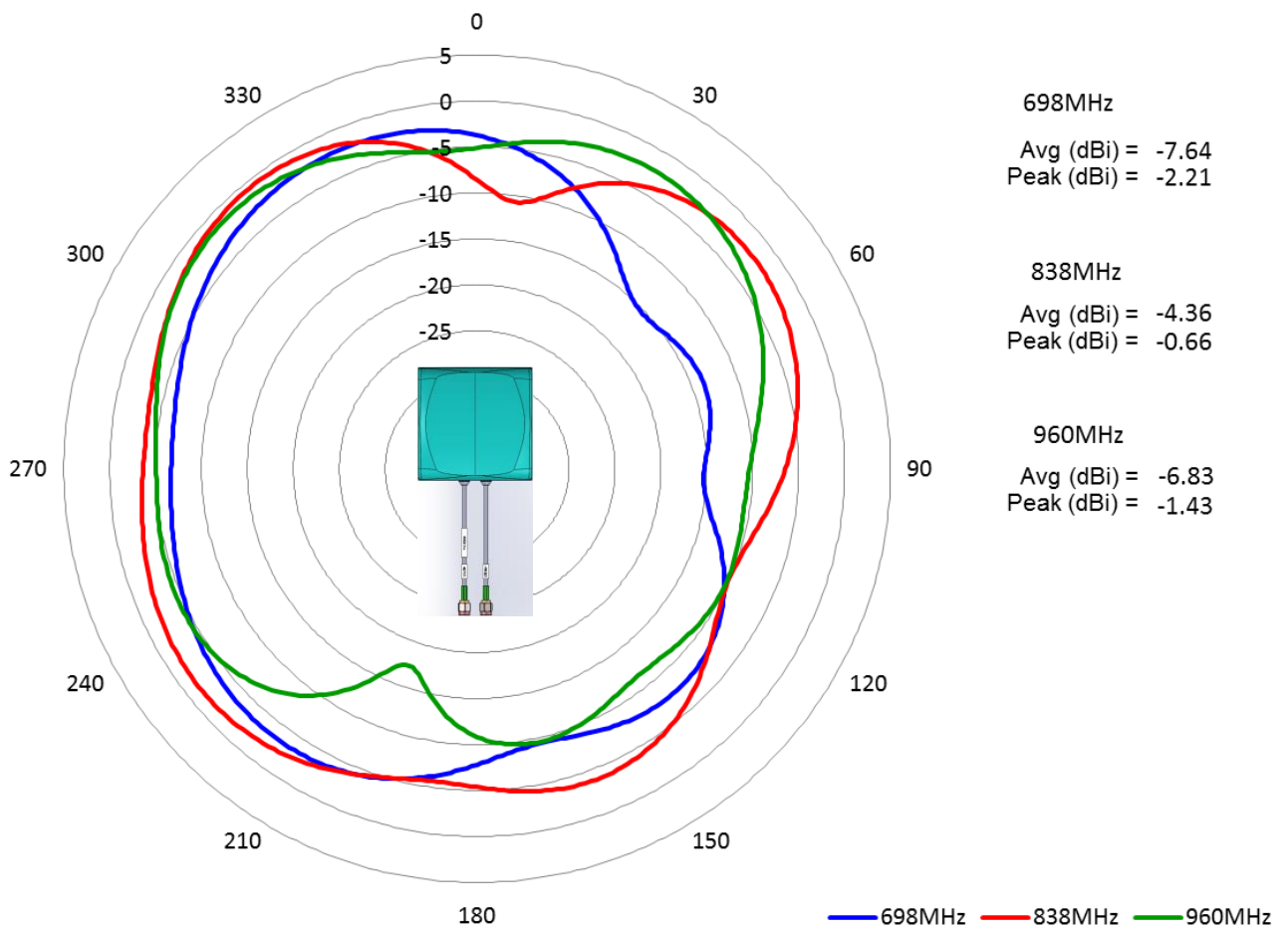

Note : Antenna measured in free space with 150mm cable

Issue: 1915

In the effort to improve our products, we reserve the right to make changes judged to be necessary.

CONFIDENTIAL AND PROPRIETARY INFORMATION

This document contains confidential and proprietary information of Pulse Electronics, Inc. (Pulse) and is protected by copyright, trade secret and other state and federal laws. Its receipt or possession does not convey any rights to reproduce, disclose its contents, or to manufacture, use or sell anything it may describe. Reproduction, disclosure or use without specific written authorization of Pulse is strictly forbidden.

**Description:** 3G/4G LTE 2xMiMo Vehicular Antenna

**Series:** Jaguar

**PART NUMBER:** W1919

CHARTS

Gain Plots (Main LTE)

ZX Plane

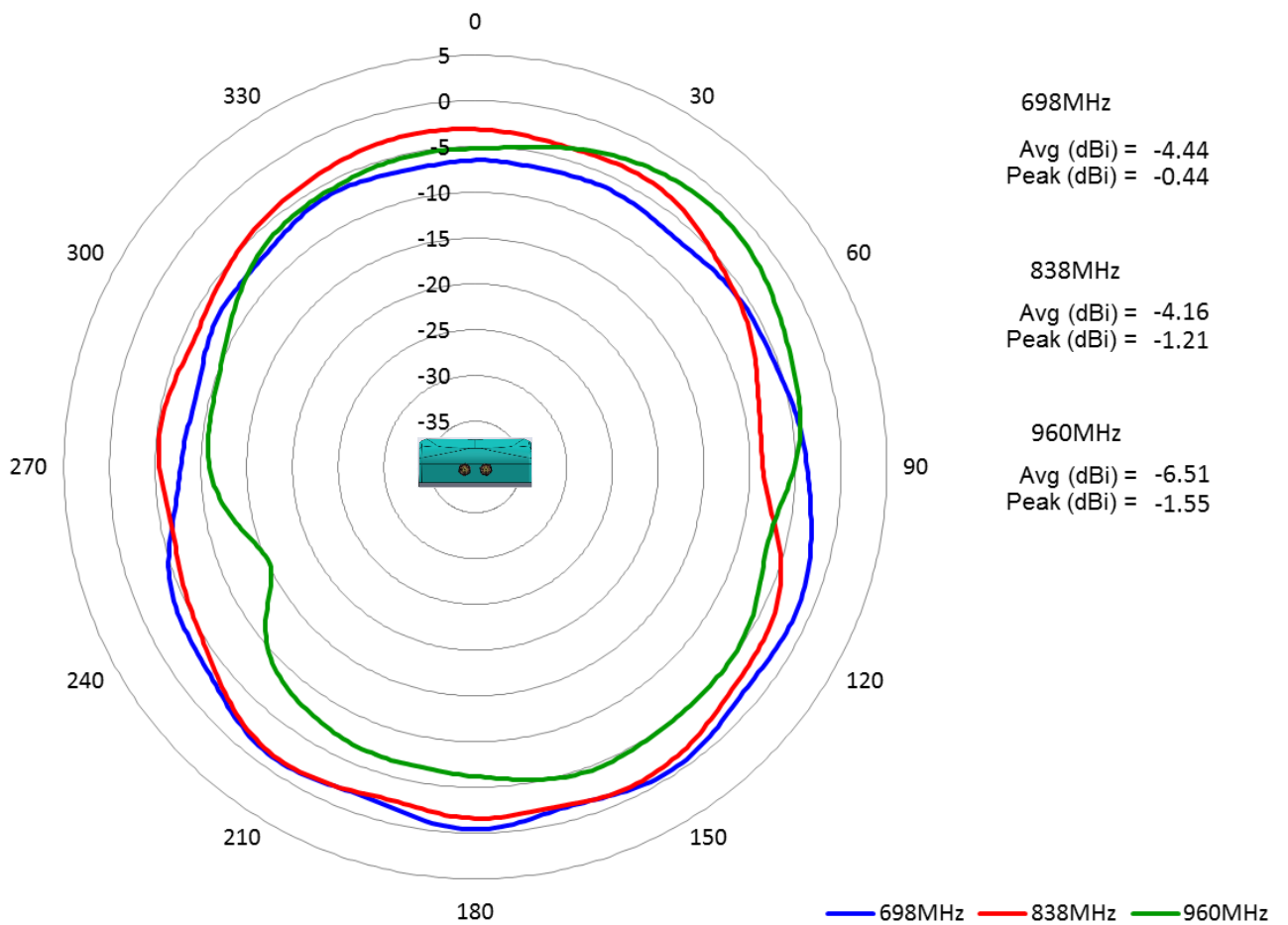

Note : Antenna measured in free space with 150mm cable

Issue: 1915

In the effort to improve our products, we reserve the right to make changes judged to be necessary.

CONFIDENTIAL AND PROPRIETARY INFORMATION

This document contains confidential and proprietary information of Pulse Electronics, Inc. (Pulse) and is protected by copyright, trade secret and other state and federal laws. Its receipt or possession does not convey any rights to reproduce, disclose its contents, or to manufacture, use or sell anything it may describe. Reproduction, disclosure or use without specific written authorization of Pulse is strictly forbidden.



**Description:** 3G/4G LTE 2xMiMo Vehicular Antenna

**Series:** Jaguar

**PART NUMBER:** W1919

CHARTS

Gain Plots (Main LTE)

ZY Plane

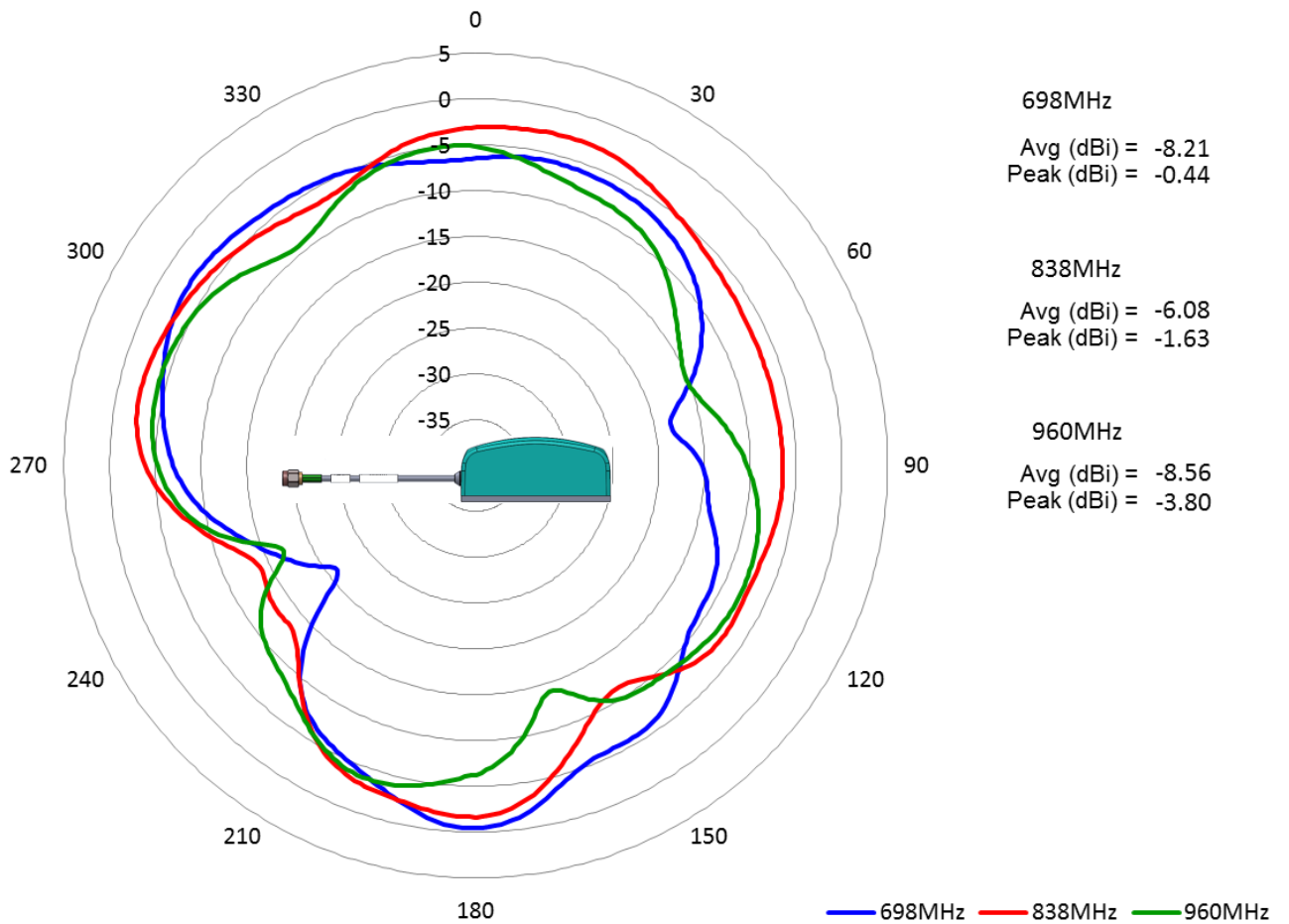

Note : Antenna measured in free space with 150mm cable

Issue: 1915

In the effort to improve our products, we reserve the right to make changes judged to be necessary.

CONFIDENTIAL AND PROPRIETARY INFORMATION

This document contains confidential and proprietary information of Pulse Electronics, Inc. (Pulse) and is protected by copyright, trade secret and other state and federal laws. Its receipt or possession does not convey any rights to reproduce, disclose its contents, or to manufacture, use or sell anything it may describe. Reproduction, disclosure or use without specific written authorization of Pulse is strictly forbidden.



Description: 3G/4G LTE 2xMiMo Vehicular Antenna

Series: Jaguar

PART NUMBER: W1919

CHARTS

Gain Plots (Main LTE)

XY Plane

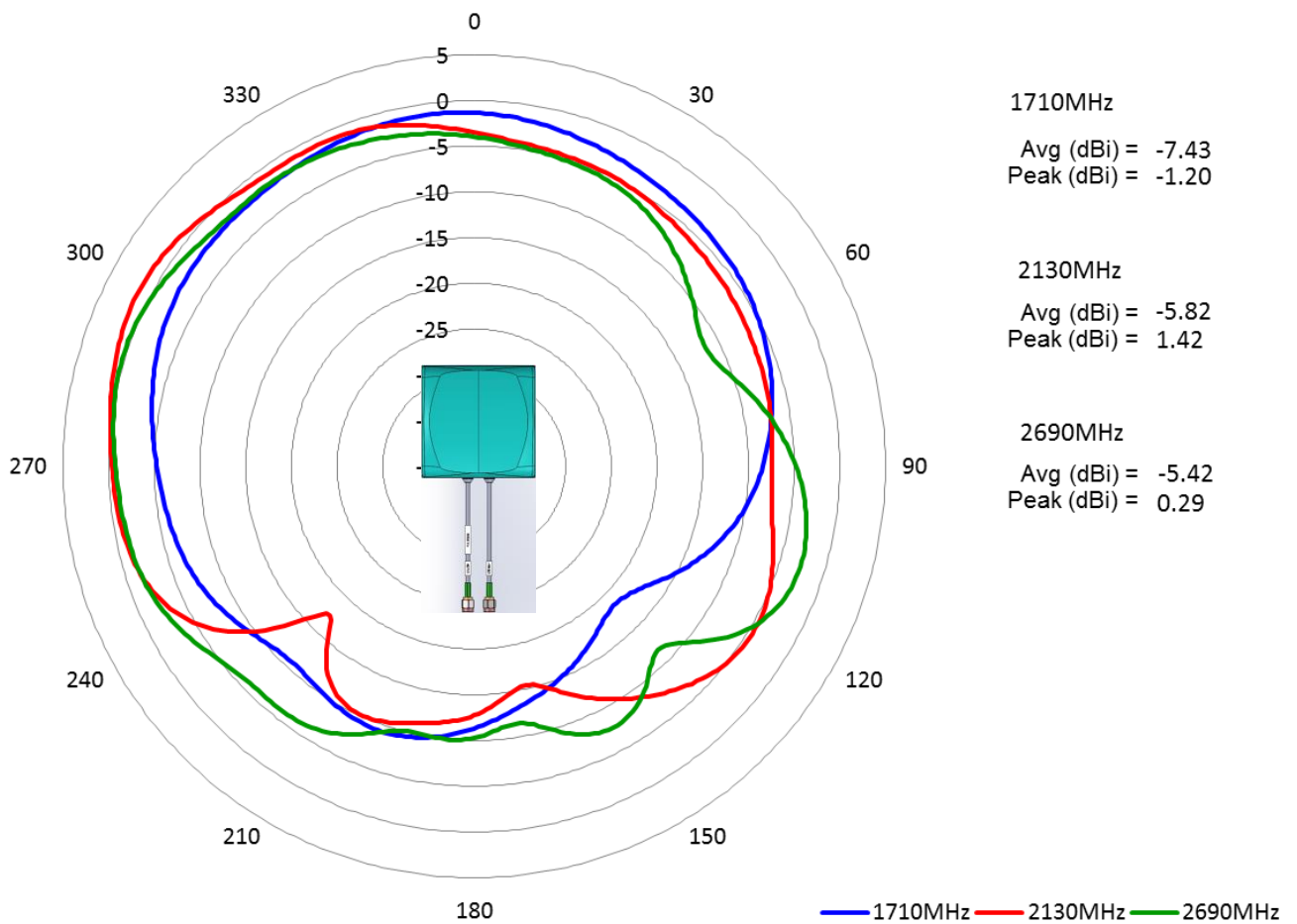

Note : Antenna measured in free space with 150mm cable

Issue: 1915

In the effort to improve our products, we reserve the right to make changes judged to be necessary.

CONFIDENTIAL AND PROPRIETARY INFORMATION

This document contains confidential and proprietary information of Pulse Electronics, Inc. (Pulse) and is protected by copyright, trade secret and other state and federal laws. Its receipt or possession does not convey any rights to reproduce, disclose its contents, or to manufacture, use or sell anything it may describe. Reproduction, disclosure or use without specific written authorization of Pulse is strictly forbidden.

**Description:** 3G/4G LTE 2xMiMo Vehicular Antenna

**Series:** Jaguar

**PART NUMBER:** W1919

**CHARTS**

**Gain Plots (Main LTE)**

ZX Plane

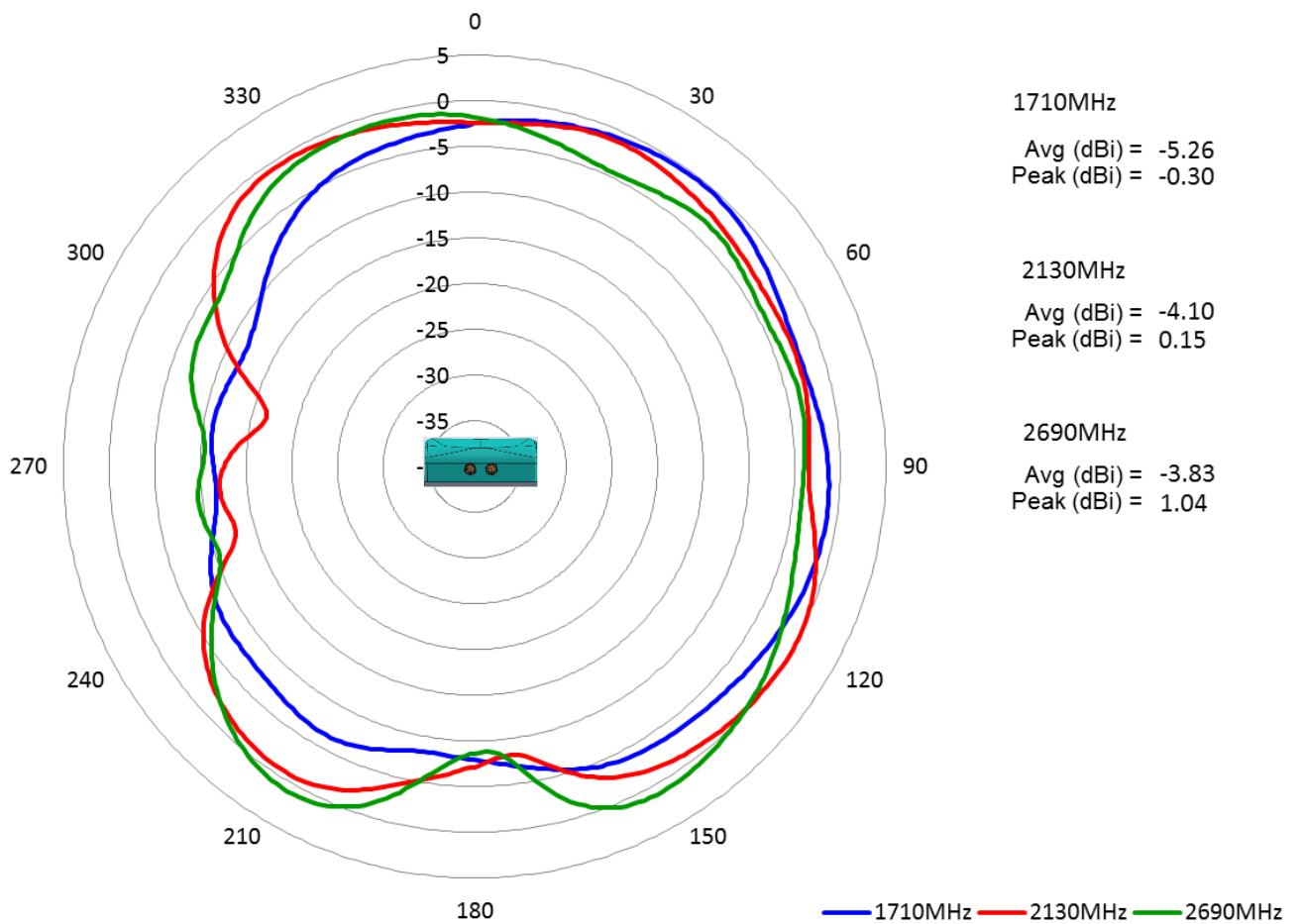

Note : Antenna measured in free space with 150mm cable

Issue: 1915

In the effort to improve our products, we reserve the right to make changes judged to be necessary.

CONFIDENTIAL AND PROPRIETARY INFORMATION

This document contains confidential and proprietary information of Pulse Electronics, Inc. (Pulse) and is protected by copyright, trade secret and other state and federal laws. Its receipt or possession does not convey any rights to reproduce, disclose its contents, or to manufacture, use or sell anything it may describe. Reproduction, disclosure or use without specific written authorization of Pulse is strictly forbidden.

**Description:** 3G/4G LTE 2xMiMo Vehicular Antenna

**Series:** Jaguar

**PART NUMBER:** W1919

**CHARTS**

**Gain Plots (Main LTE)**

ZY Plane

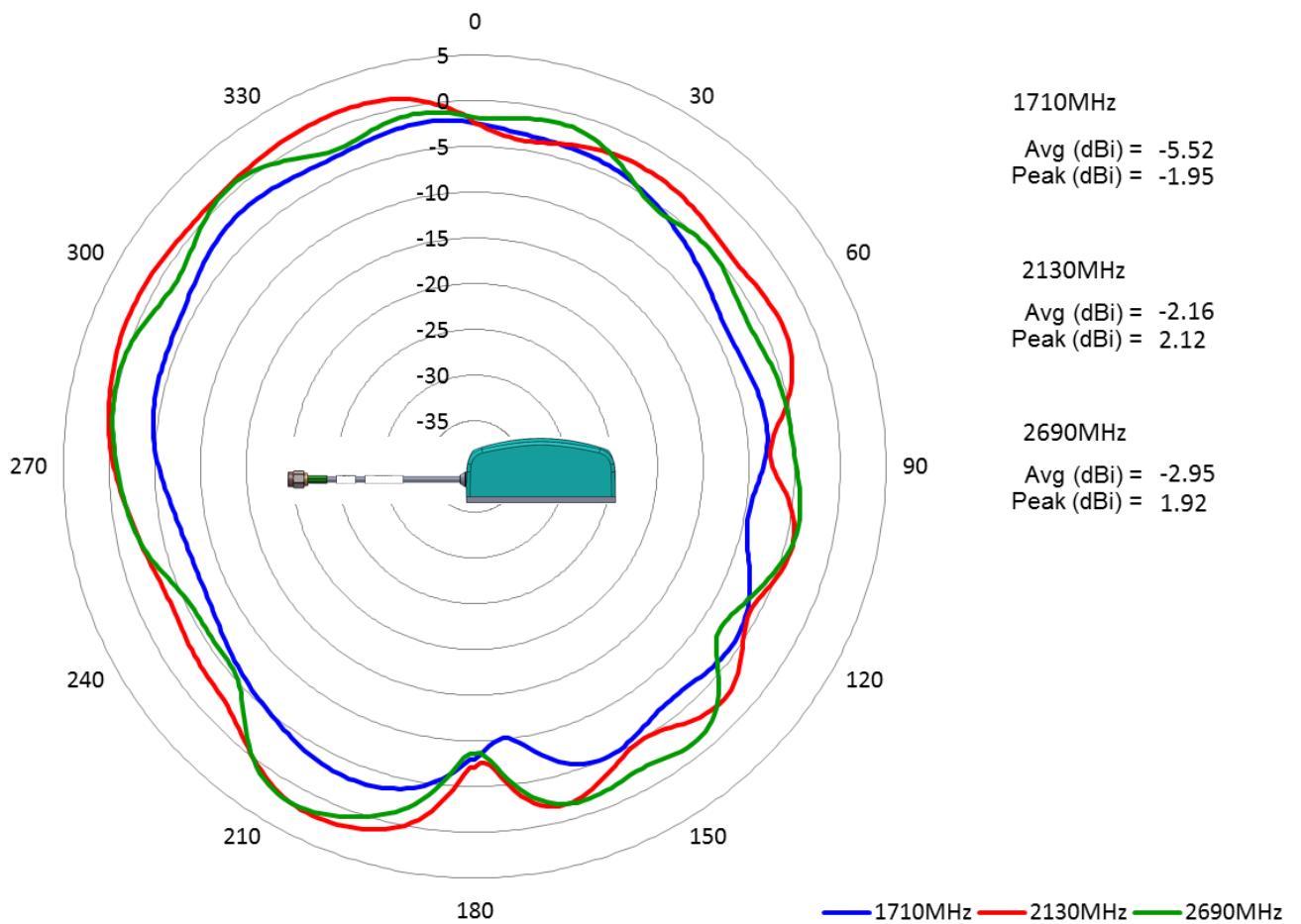

Note : Antenna measured in free space with 150mm cable

Issue: 1915

In the effort to improve our products, we reserve the right to make changes judged to be necessary.  
CONFIDENTIAL AND PROPRIETARY INFORMATION

This document contains confidential and proprietary information of Pulse Electronics, Inc. (Pulse) and is protected by copyright, trade secret and other state and federal laws. Its receipt or possession does not convey any rights to reproduce, disclose its contents, or to manufacture, use or sell anything it may describe. Reproduction, disclosure or use without specific written authorization of Pulse is strictly forbidden.

**Description:** 3G/4G LTE 2xMiMo Vehicular Antenna

**Series:** Jaguar

**PART NUMBER:** W1919

**CHARTS**

**Gain Plots (Main LTE)**

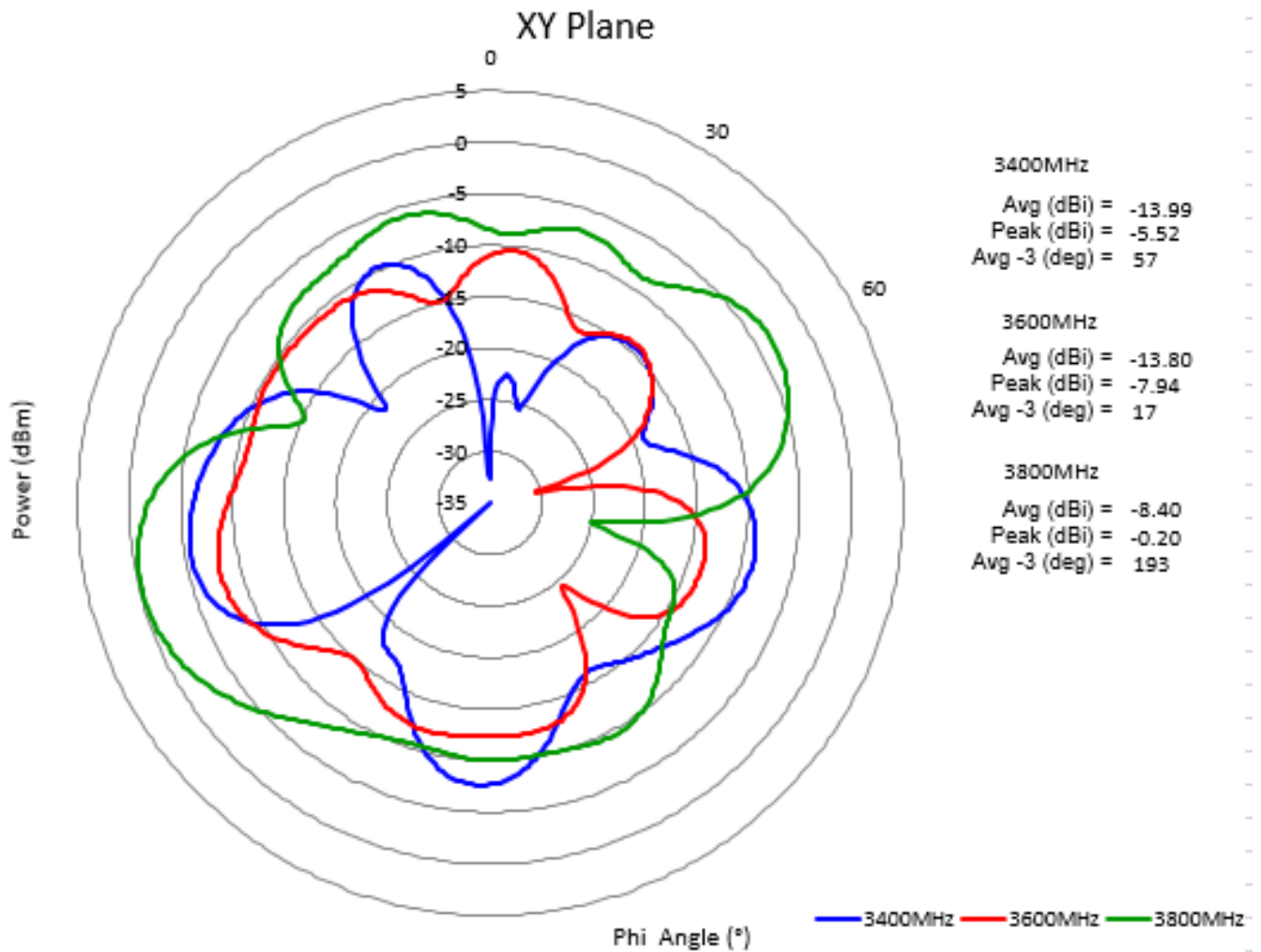

Note : Antenna measured in free space with 150mm cable

Issue: 1915

In the effort to improve our products, we reserve the right to make changes judged to be necessary.  
CONFIDENTIAL AND PROPRIETARY INFORMATION

This document contains confidential and proprietary information of Pulse Electronics, Inc. (Pulse) and is protected by copyright, trade secret and other state and federal laws. Its receipt or possession does not convey any rights to reproduce, disclose its contents, or to manufacture, use or sell anything it may describe. Reproduction, disclosure or use without specific written authorization of Pulse is strictly forbidden.

Description: 3G/4G LTE 2xMiMo Vehicular Antenna

Series: Jaguar

PART NUMBER: W1919

CHARTS

Gain Plots (Main LTE)

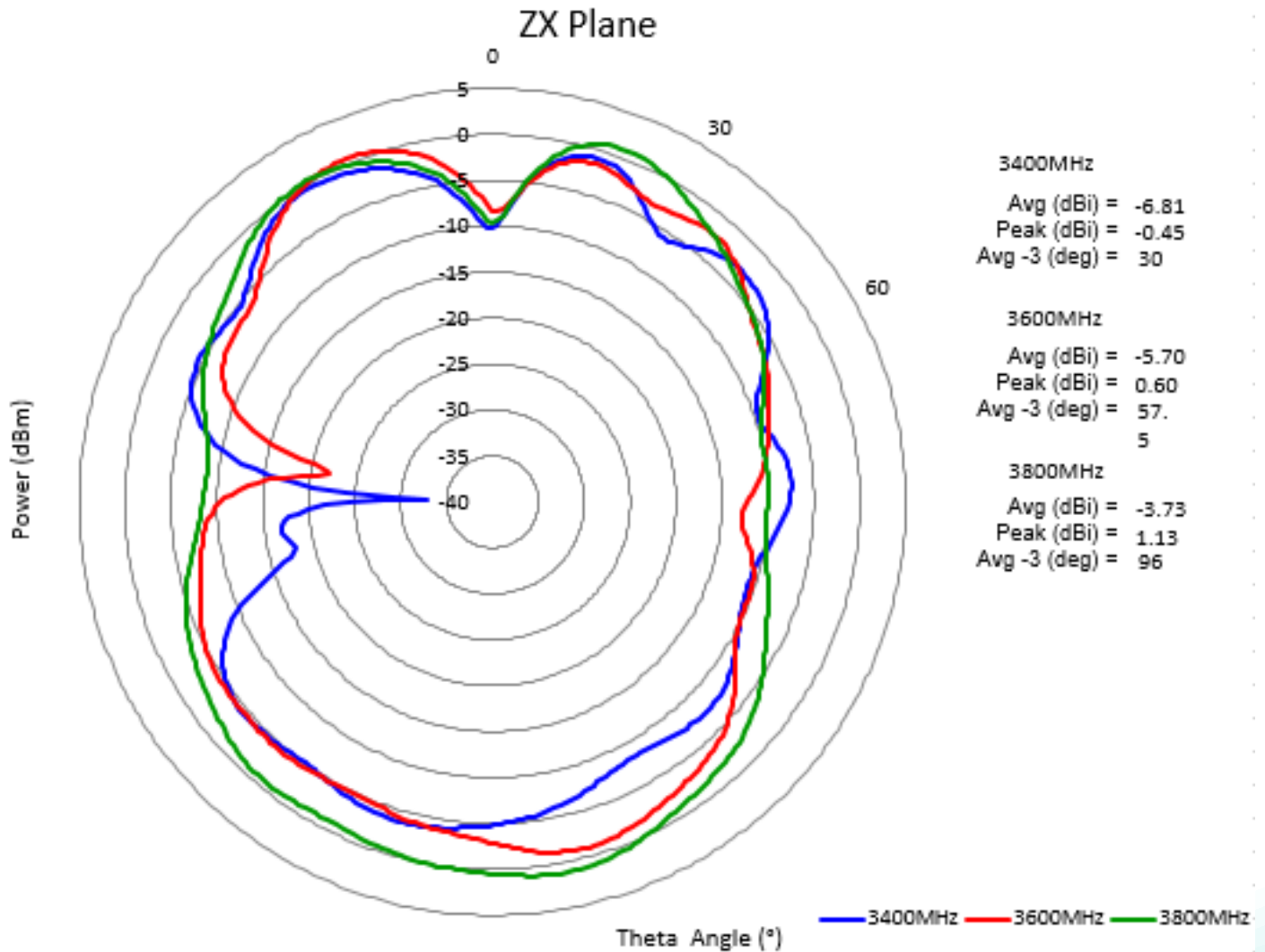

Note : Antenna measured in free space with 150mm cable

Issue: 1915

In the effort to improve our products, we reserve the right to make changes judged to be necessary.  
CONFIDENTIAL AND PROPRIETARY INFORMATION

This document contains confidential and proprietary information of Pulse Electronics, Inc. (Pulse) and is protected by copyright, trade secret and other state and federal laws. Its receipt or possession does not convey any rights to reproduce, disclose its contents, or to manufacture, use or sell anything it may describe. Reproduction, disclosure or use without specific written authorization of Pulse is strictly forbidden.

Description: 3G/4G LTE 2xMiMo Vehicular Antenna

Series: Jaguar

PART NUMBER: W1919

CHARTS

Gain Plots (Main LTE)

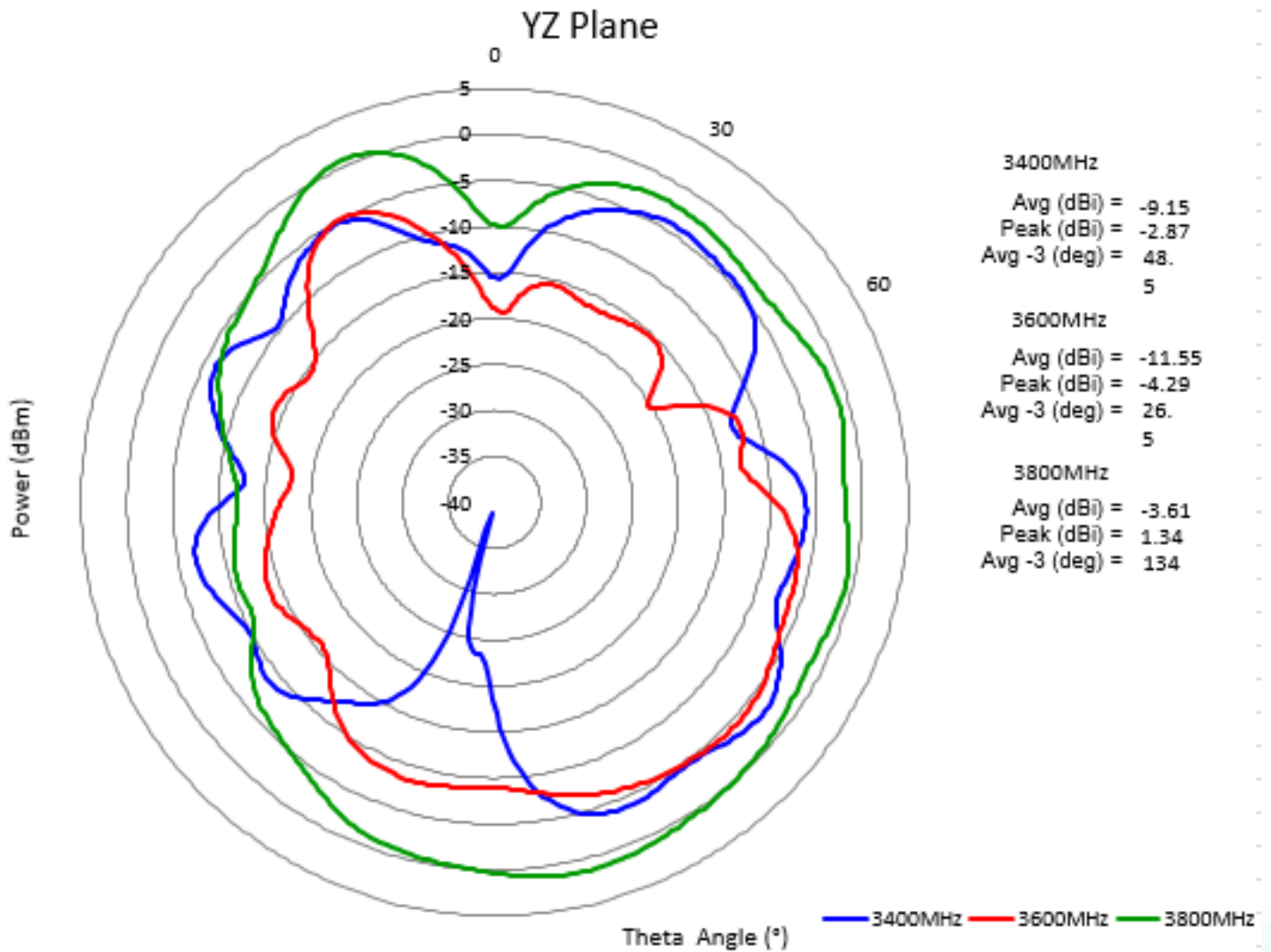

Note : Antenna measured in free space with 150mm cable

Issue: 1915

In the effort to improve our products, we reserve the right to make changes judged to be necessary.  
CONFIDENTIAL AND PROPRIETARY INFORMATION

This document contains confidential and proprietary information of Pulse Electronics, Inc. (Pulse) and is protected by copyright, trade secret and other state and federal laws. Its receipt or possession does not convey any rights to reproduce, disclose its contents, or to manufacture, use or sell anything it may describe. Reproduction, disclosure or use without specific written authorization of Pulse is strictly forbidden.



**Description:** 3G/4G LTE 2xMiMo Vehicular Antenna

**Series:** Jaguar

**PART NUMBER:** W1919

**CHARTS**

**Gain Plots (Diversity LTE)**

**XY Plane**

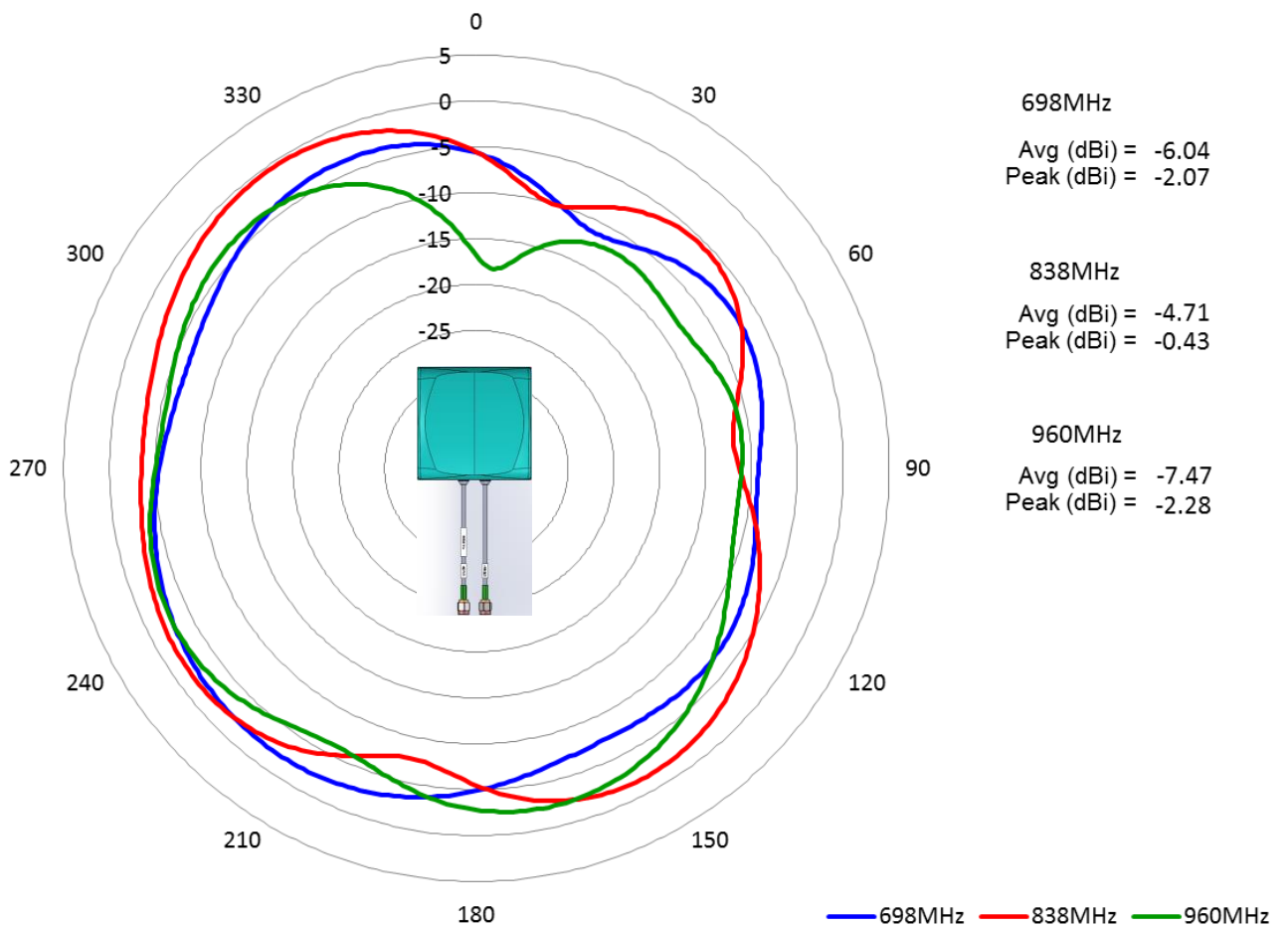

Note : Antenna measured in free space with 150mm cable

Issue: 1915

In the effort to improve our products, we reserve the right to make changes judged to be necessary.

CONFIDENTIAL AND PROPRIETARY INFORMATION

This document contains confidential and proprietary information of Pulse Electronics, Inc. (Pulse) and is protected by copyright, trade secret and other state and federal laws. Its receipt or possession does not convey any rights to reproduce, disclose its contents, or to manufacture, use or sell anything it may describe. Reproduction, disclosure or use without specific written authorization of Pulse is strictly forbidden.



**Description:** 3G/4G LTE 2xMiMo Vehicular Antenna

**Series:** Jaguar

**PART NUMBER:** W1919

**CHARTS**

**Gain Plots (Diversity LTE)**

**ZX Plane**

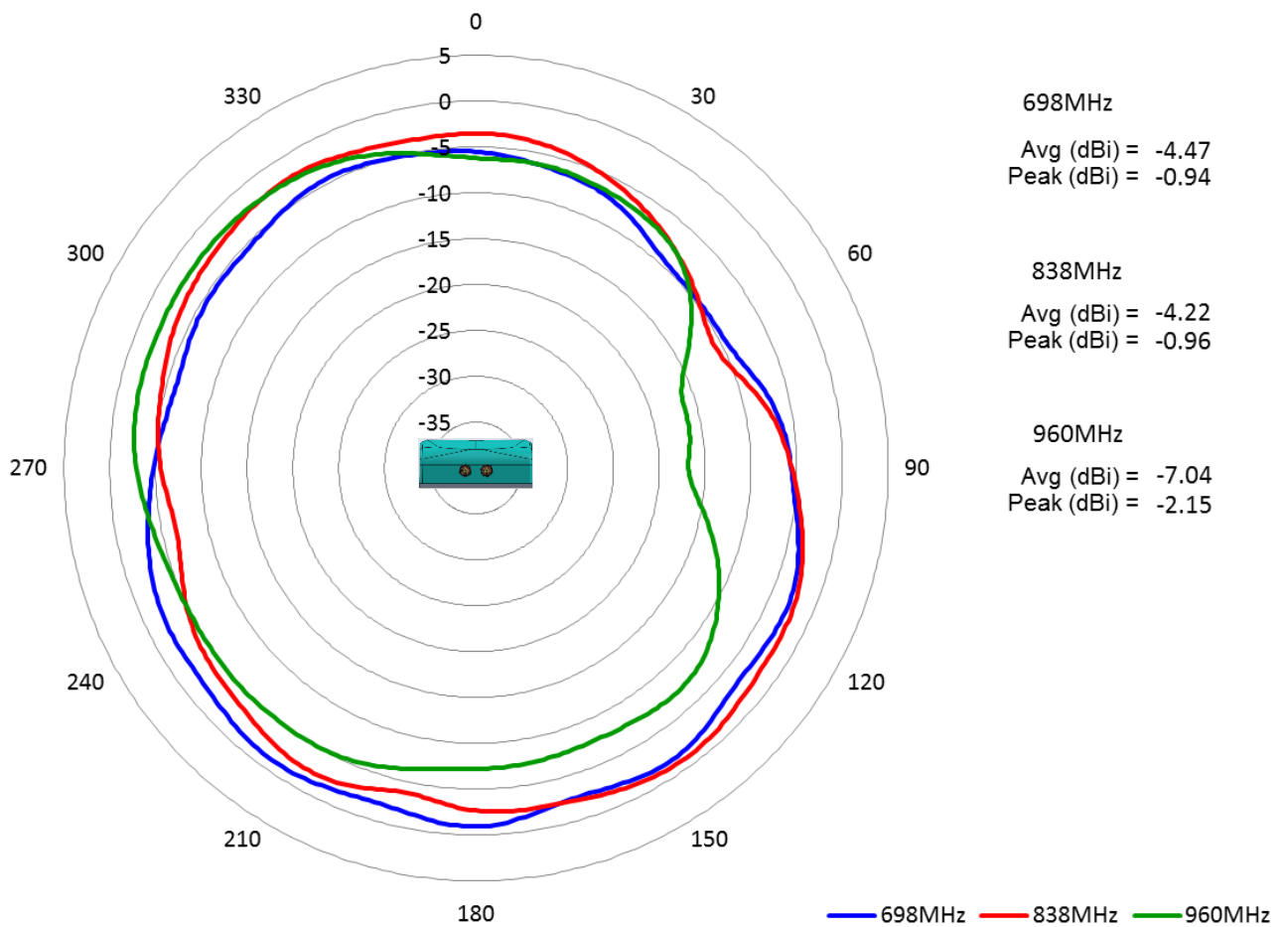

Note : Antenna measured in free space with 150mm cable

Issue: 1915

In the effort to improve our products, we reserve the right to make changes judged to be necessary.

CONFIDENTIAL AND PROPRIETARY INFORMATION

This document contains confidential and proprietary information of Pulse Electronics, Inc. (Pulse) and is protected by copyright, trade secret and other state and federal laws. Its receipt or possession does not convey any rights to reproduce, disclose its contents, or to manufacture, use or sell anything it may describe. Reproduction, disclosure or use without specific written authorization of Pulse is strictly forbidden.

**Description:** 3G/4G LTE 2xMiMo Vehicular Antenna

**Series:** Jaguar

**PART NUMBER:** W1919

CHARTS

Gain Plots (Diversity LTE)

ZY Plane

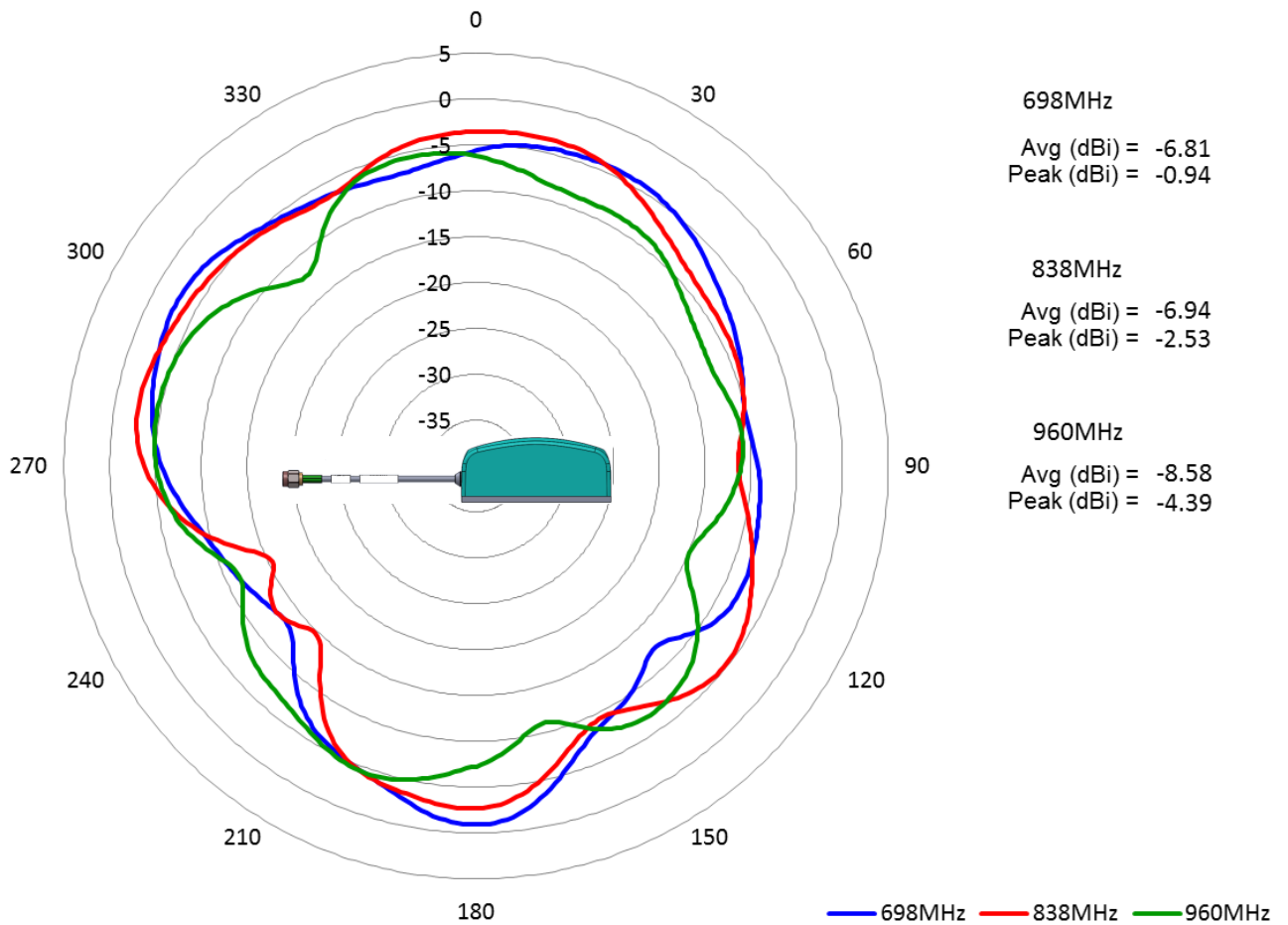

Note : Antenna measured in free space with 150mm cable

Issue: 1915

In the effort to improve our products, we reserve the right to make changes judged to be necessary.

CONFIDENTIAL AND PROPRIETARY INFORMATION

This document contains confidential and proprietary information of Pulse Electronics, Inc. (Pulse) and is protected by copyright, trade secret and other state and federal laws. Its receipt or possession does not convey any rights to reproduce, disclose its contents, or to manufacture, use or sell anything it may describe. Reproduction, disclosure or use without specific written authorization of Pulse is strictly forbidden.

**Description:** 3G/4G LTE 2xMiMo Vehicular Antenna

**Series:** Jaguar

**PART NUMBER:** W1919

**CHARTS**

**Gain Plots (Diversity LTE)**

XY Plane

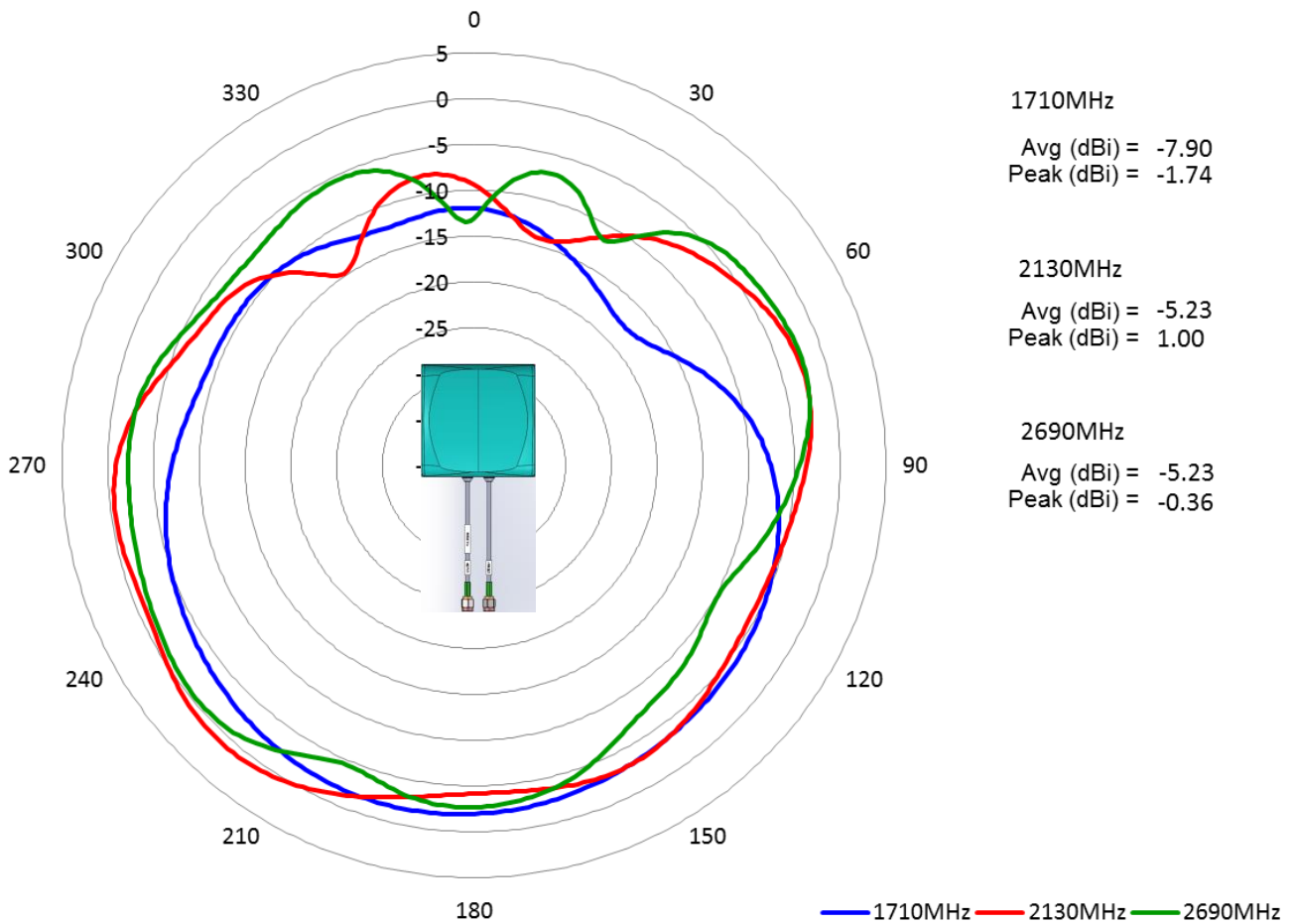

Note : Antenna measured in free space with 150mm cable

Issue: 1915

In the effort to improve our products, we reserve the right to make changes judged to be necessary.

CONFIDENTIAL AND PROPRIETARY INFORMATION

This document contains confidential and proprietary information of Pulse Electronics, Inc. (Pulse) and is protected by copyright, trade secret and other state and federal laws. Its receipt or possession does not convey any rights to reproduce, disclose its contents, or to manufacture, use or sell anything it may describe. Reproduction, disclosure or use without specific written authorization of Pulse is strictly forbidden.

**Description:** 3G/4G LTE 2xMiMo Vehicular Antenna

**Series:** Jaguar

**PART NUMBER:** W1919

**CHARTS**

**Gain Plots (Diversity LTE)**

ZX Plane

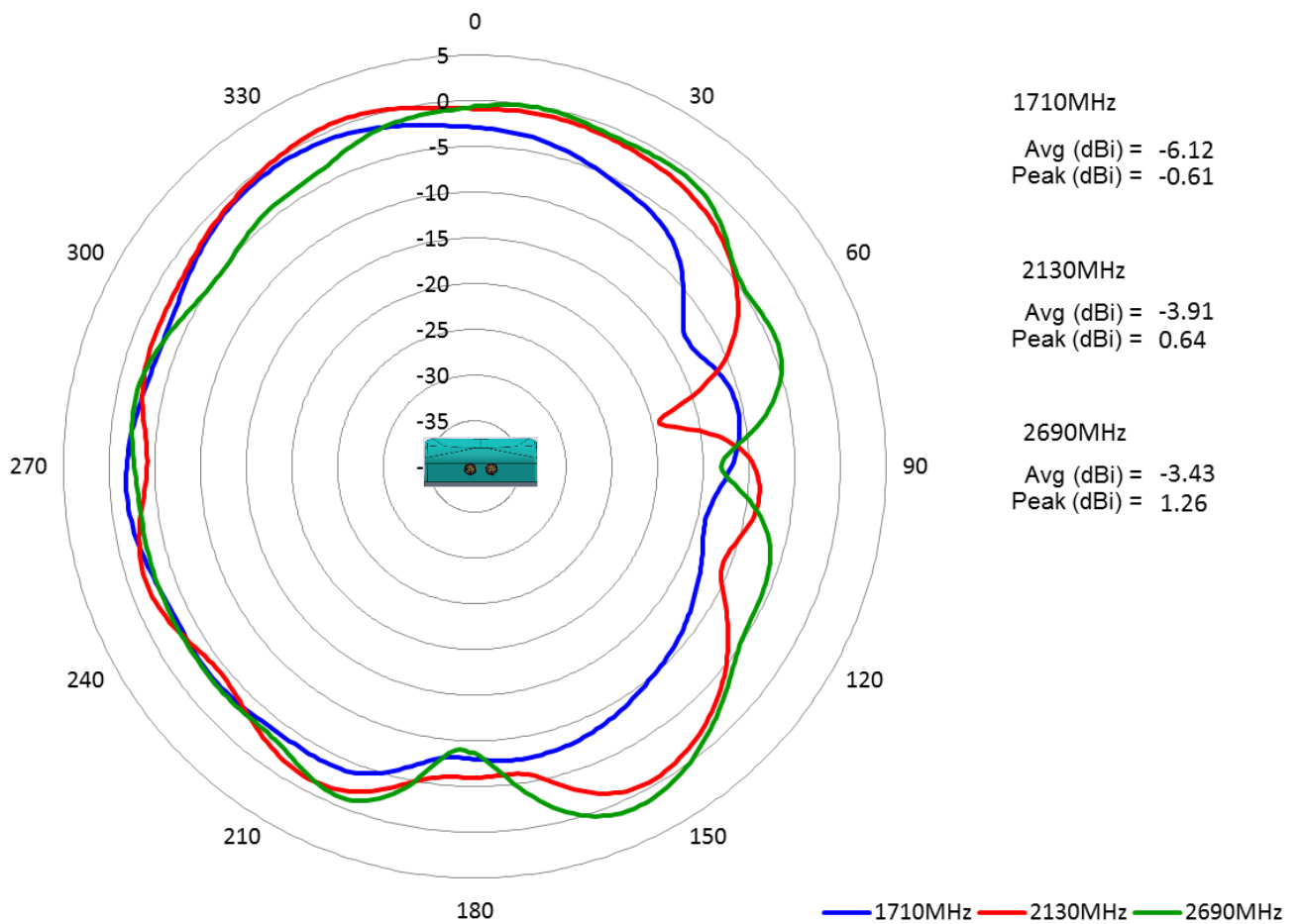

Note : Antenna measured in free space with 150mm cable

Issue: 1915

In the effort to improve our products, we reserve the right to make changes judged to be necessary.

CONFIDENTIAL AND PROPRIETARY INFORMATION

This document contains confidential and proprietary information of Pulse Electronics, Inc. (Pulse) and is protected by copyright, trade secret and other state and federal laws. Its receipt or possession does not convey any rights to reproduce, disclose its contents, or to manufacture, use or sell anything it may describe. Reproduction, disclosure or use without specific written authorization of Pulse is strictly forbidden.

**Description:** 3G/4G LTE 2xMiMo Vehicular Antenna

**Series:** Jaguar

**PART NUMBER:** W1919

**CHARTS**

**Gain Plots (Diversity LTE)**

ZY Plane

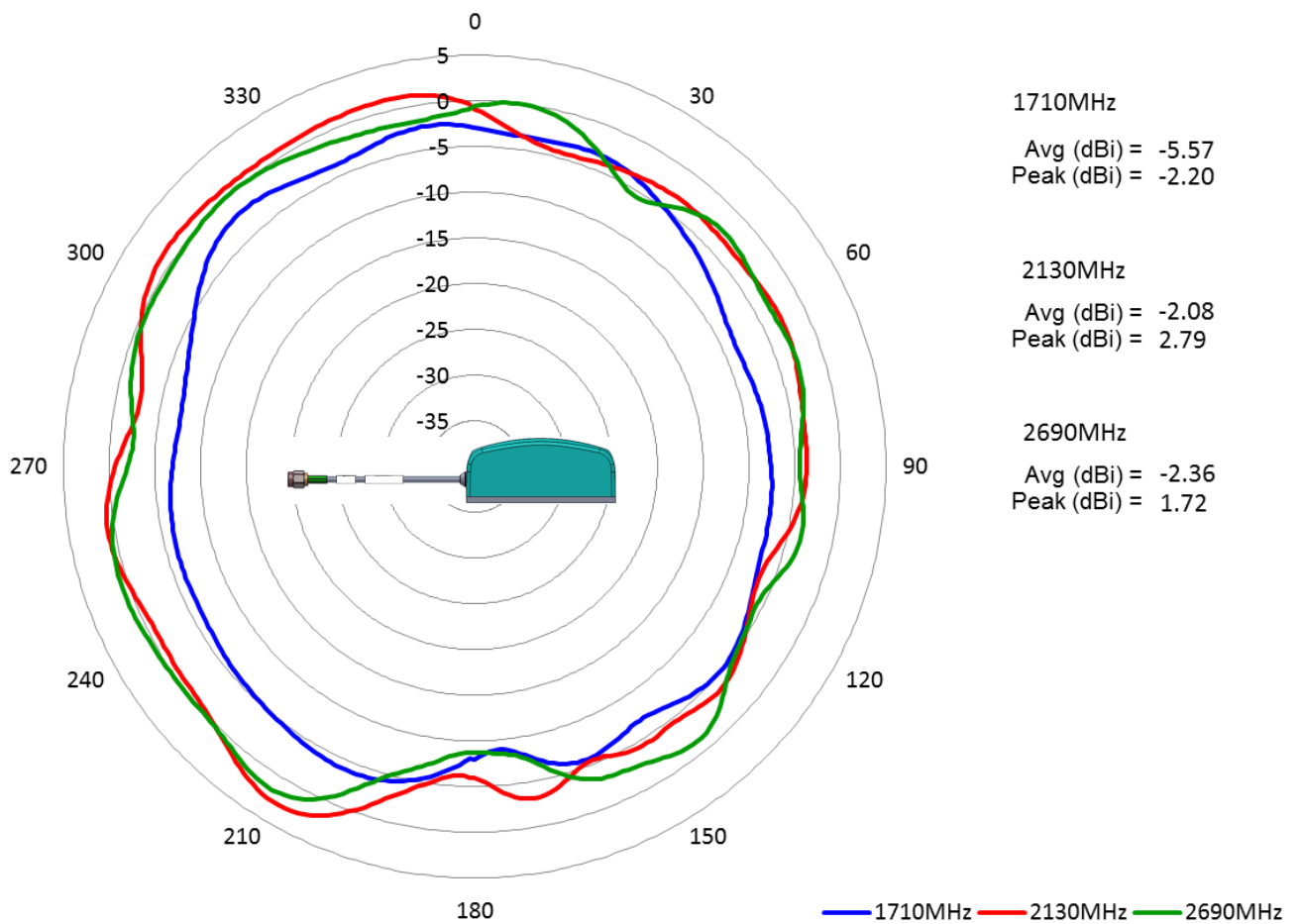

Note : Antenna measured in free space with 150mm cable

Issue: 1915

In the effort to improve our products, we reserve the right to make changes judged to be necessary.

CONFIDENTIAL AND PROPRIETARY INFORMATION

This document contains confidential and proprietary information of Pulse Electronics, Inc. (Pulse) and is protected by copyright, trade secret and other state and federal laws. Its receipt or possession does not convey any rights to reproduce, disclose its contents, or to manufacture, use or sell anything it may describe. Reproduction, disclosure or use without specific written authorization of Pulse is strictly forbidden.

Description: 3G/4G LTE 2xMiMo Vehicular Antenna

Series: Jaguar

PART NUMBER: W1919

CHARTS

Gain Plots (Diversity LTE)

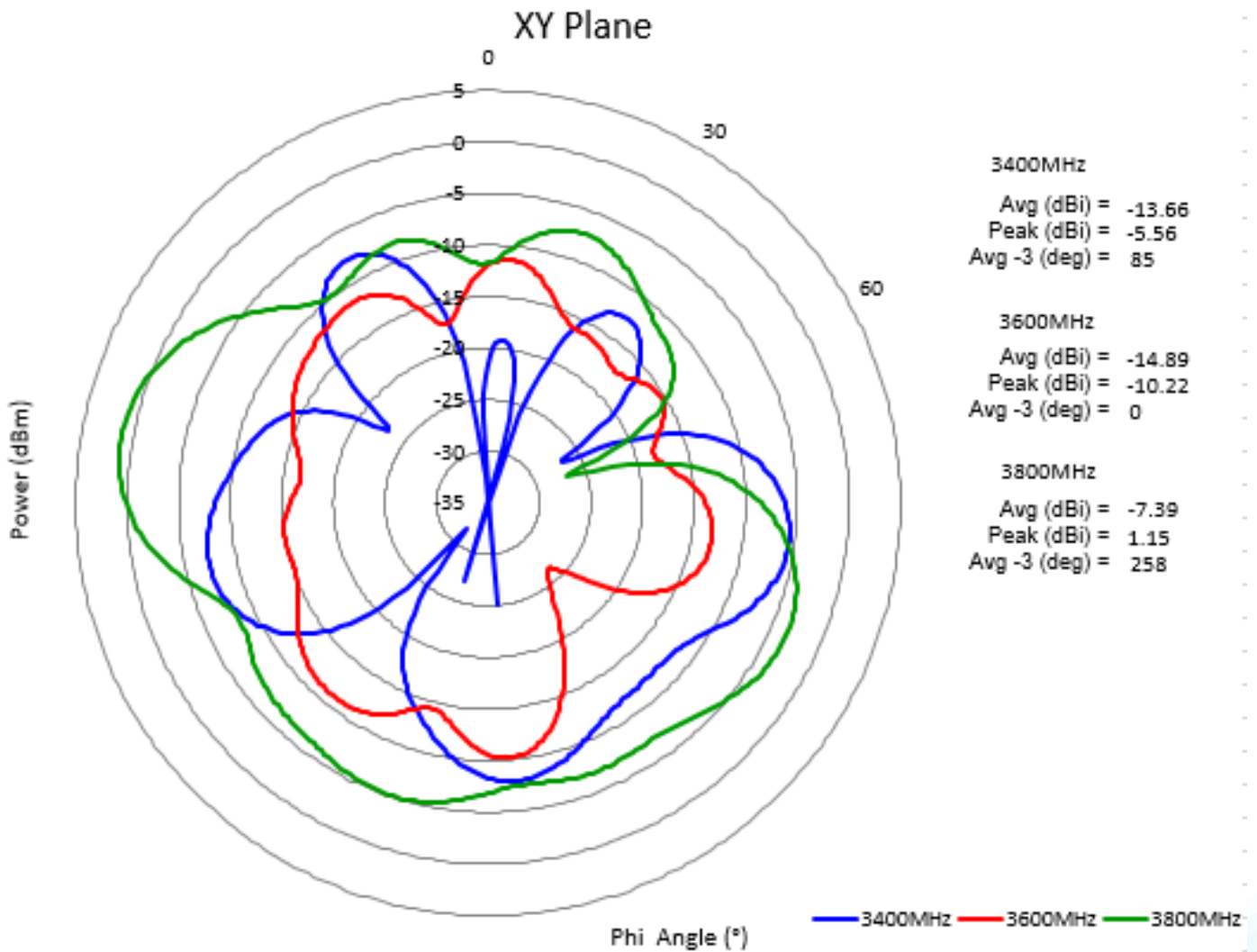

Note : Antenna measured in free space with 150mm cable

Issue: 1915

In the effort to improve our products, we reserve the right to make changes judged to be necessary.  
CONFIDENTIAL AND PROPRIETARY INFORMATION

This document contains confidential and proprietary information of Pulse Electronics, Inc. (Pulse) and is protected by copyright, trade secret and other state and federal laws. Its receipt or possession does not convey any rights to reproduce, disclose its contents, or to manufacture, use or sell anything it may describe. Reproduction, disclosure or use without specific written authorization of Pulse is strictly forbidden.



**Description:** 3G/4G LTE 2xMiMo Vehicular Antenna

**Series:** Jaguar

**PART NUMBER:** W1919

**CHARTS**

**Gain Plots (Diversity LTE)**

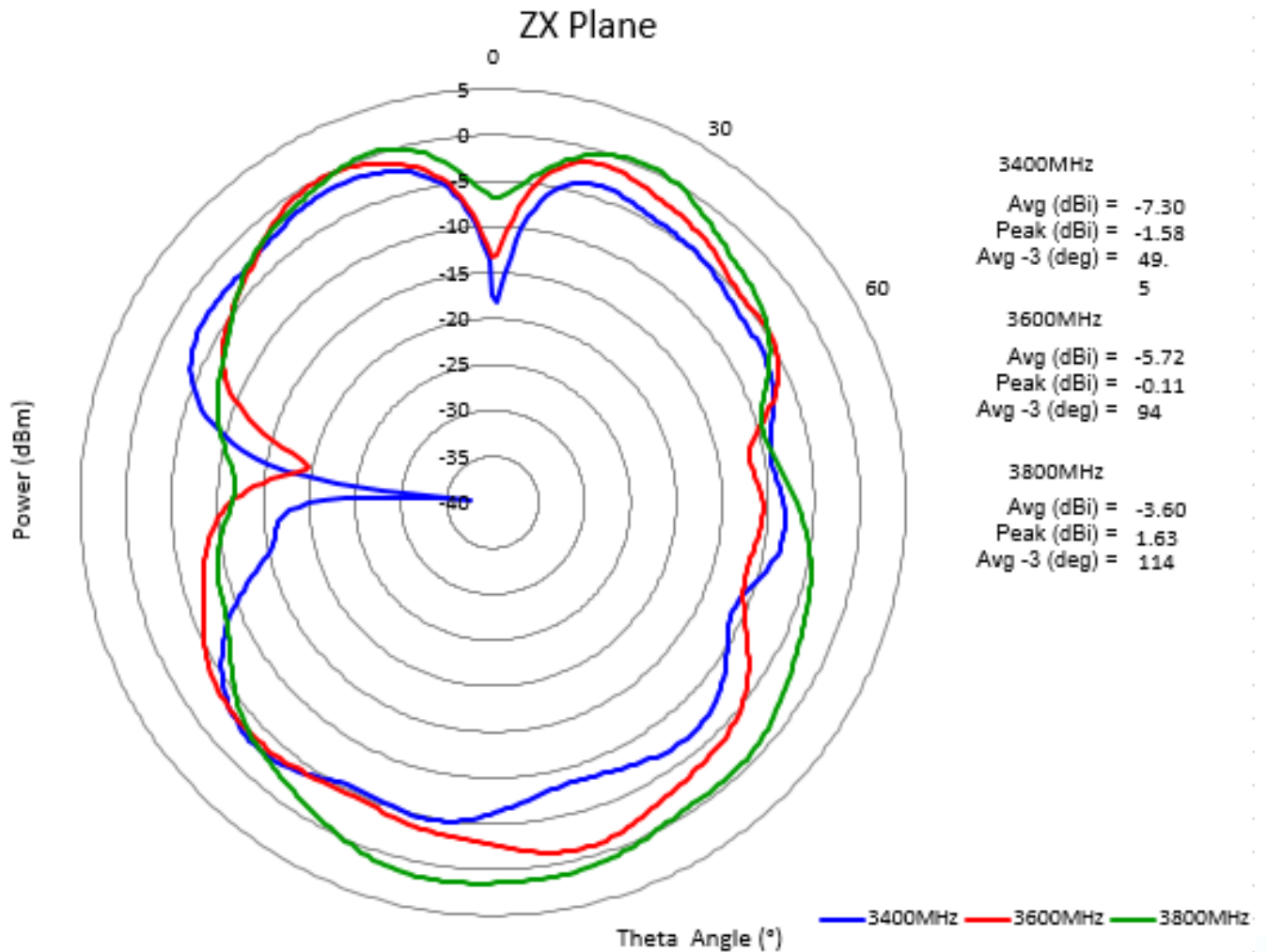

Note : Antenna measured in free space with 150mm cable

Issue: 1915

In the effort to improve our products, we reserve the right to make changes judged to be necessary.  
CONFIDENTIAL AND PROPRIETARY INFORMATION

This document contains confidential and proprietary information of Pulse Electronics, Inc. (Pulse) and is protected by copyright, trade secret and other state and federal laws. Its receipt or possession does not convey any rights to reproduce, disclose its contents, or to manufacture, use or sell anything it may describe. Reproduction, disclosure or use without specific written authorization of Pulse is strictly forbidden.



Description: 3G/4G LTE 2xMiMo Vehicular Antenna

Series: Jaguar

PART NUMBER: W1919

CHARTS

Gain Plots (Diversity LTE)

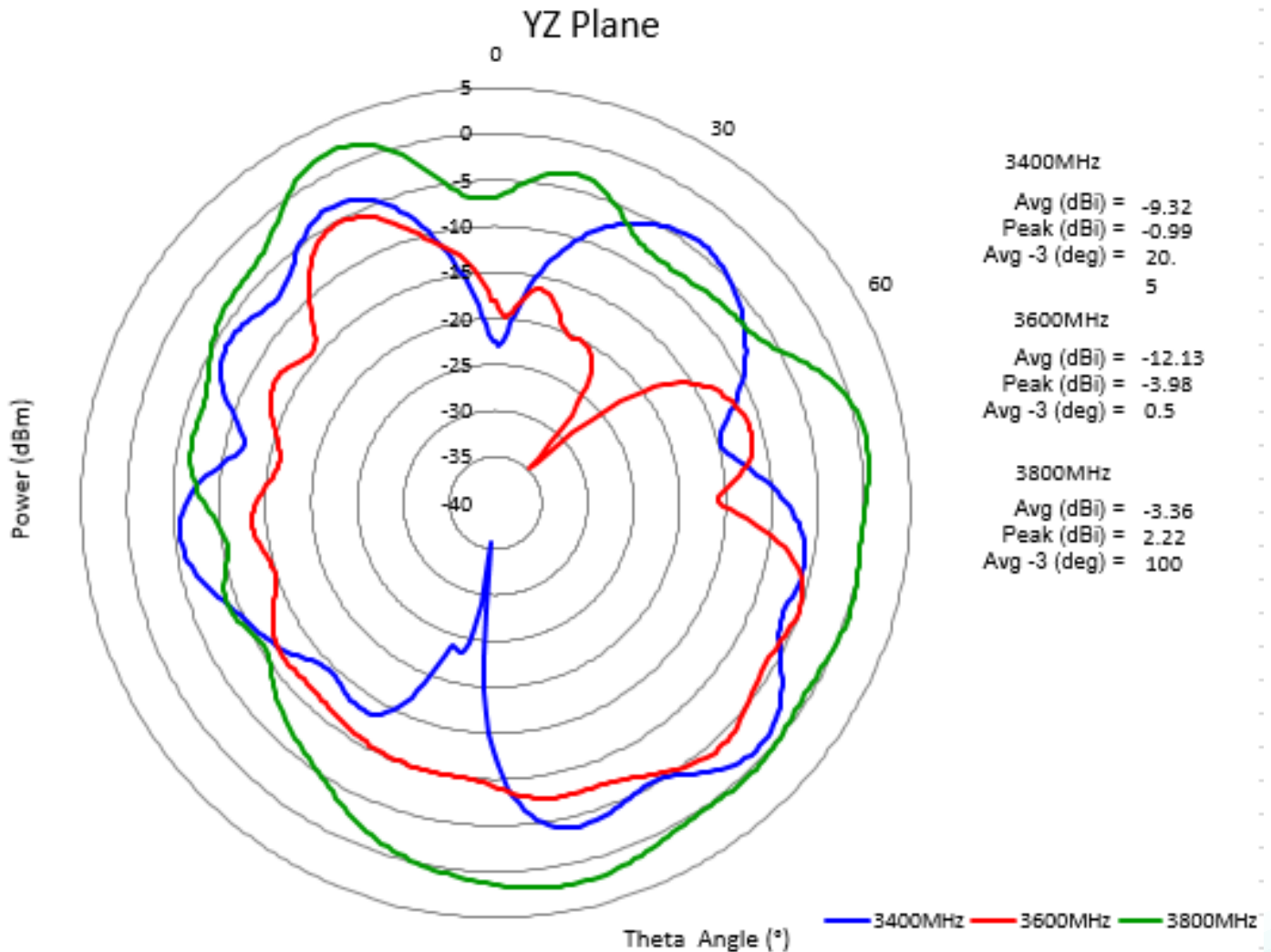

Note : Antenna measured in free space with 150mm cable

Issue: 1915

In the effort to improve our products, we reserve the right to make changes judged to be necessary.  
CONFIDENTIAL AND PROPRIETARY INFORMATION

This document contains confidential and proprietary information of Pulse Electronics, Inc. (Pulse) and is protected by copyright, trade secret and other state and federal laws. Its receipt or possession does not convey any rights to reproduce, disclose its contents, or to manufacture, use or sell anything it may describe. Reproduction, disclosure or use without specific written authorization of Pulse is strictly forbidden.

**Series: Jaguar**

**Description: 3G/4G LTE 2xMiMo Vehicular Antenna**

**PART NUMBER: W1919**

## PACKAGING

1pcs antennas per foam bag

12pcs antennas per package box

Package box: 558mm\*386mm\*210mm

Issue: 1915

In the effort to improve our products, we reserve the right to make changes judged to be necessary.

CONFIDENTIAL AND PROPRIETARY INFORMATION

This document contains confidential and proprietary information of Pulse Electronics, Inc. (Pulse) and is protected by copyright, trade secret and other state and federal laws. Its receipt or possession does not convey any rights to reproduce, disclose its contents, or to manufacture, use or sell anything it may describe. Reproduction, disclosure or use without specific written authorization of Pulse is strictly forbidden.