









Features:

-  Ultra low noise 15dB amplifiers
-  Stacked L1 / L5 patch antenna
-  Single RF input with DC bias
-  High rejection filters to suppress out of band interference
-  ESD Protected
-  For 30dB version use P/N: GNSSL1L5182530

Applications:

-  GPS, Glonass, Galileo, Beidou, IRNSS
-  Multiband satellite navigation receivers
-  L1 and L5 band devices

Electrical specifications¹ @ 25° C

Antenna type	Nominal Impedance	Polarization	Radiation pattern
Patch	50Ω	RHCP	Directional
Frequency (MHz)	L1: 1561-1602		L5: 1164-1189
Return Loss (dB)	< -8		< -12
Radiating Element Peak Gain (dBi/dBic)	>4/1.6		>3/2.6
Avg. Efficiency (%)	>60		>55
LNA Gain (dB) Typical	14		16
Noise Figure (dB)	1.6 @1575MHz		2.3 @1164MHz
Operating Voltage² (V)	2.5 - 18		
Power Consumption	Max. 11mA		

Mechanical Specifications

Dimension	Color	Antenna Material	Connector Type	Cable Type
Length x Width x Height (w/o cable)				
30mm*30mm*12.69mm/1.181"x1.181"x.500"	Gray	Ceramic+PCB+cable	I-PEX MHF	Ø1.13mm
Cable Length	Weight	RoHS- Compliant	Storage and operating Temperature:	
100mm/3.937"	12 grams	Yes	-40°C to 85°C	

Notes:

1. The product is ESD sensitive, must be handled carefully and strictly according to the ESD requirements.
2. LNA internal voltage stabilized by LDO (Low dropout regulator)

Mechanical Drawing

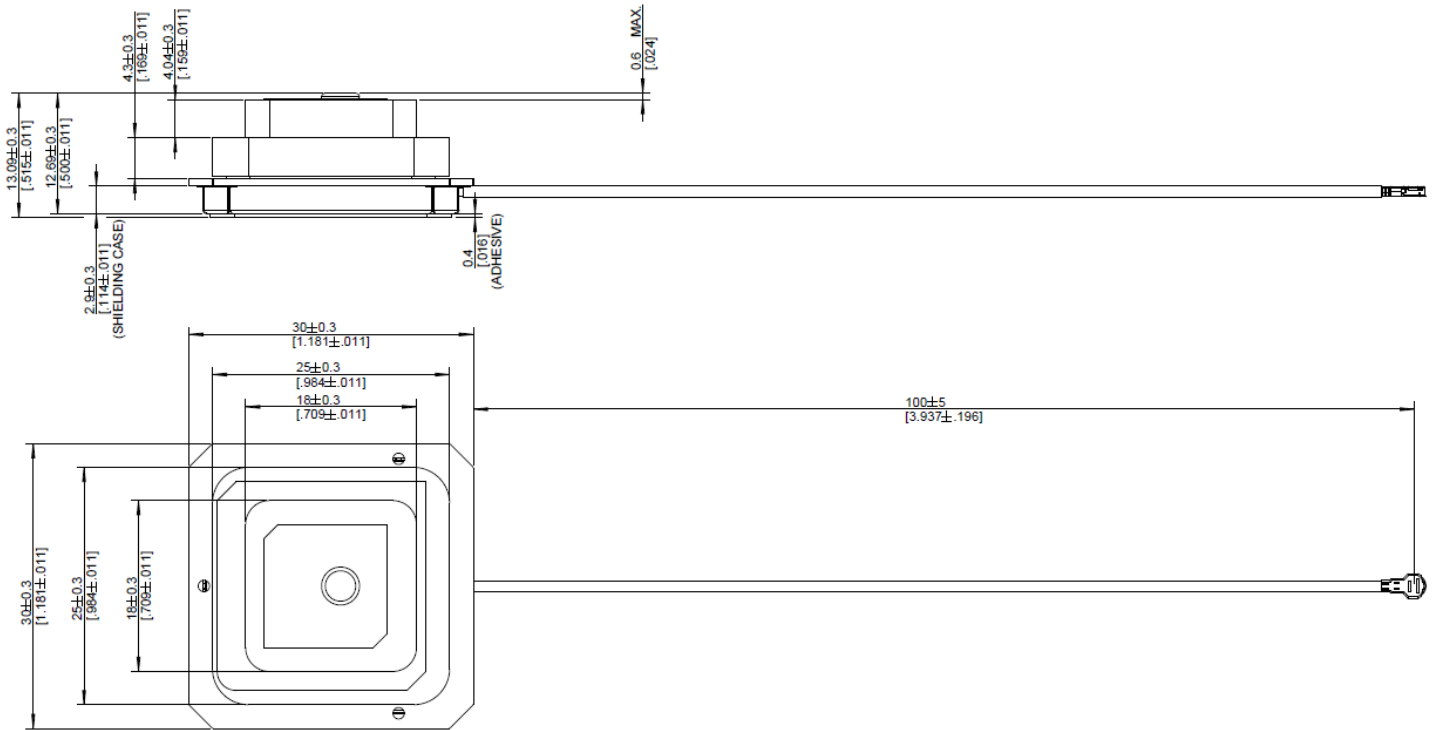

All dimensions are in mm / inches

Testing Setup

Module is tested on dia. 120mm ground plane.

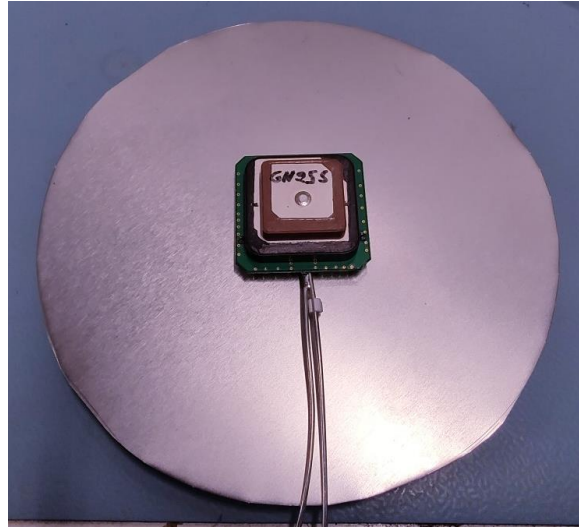

Active Antenna Block Diagram

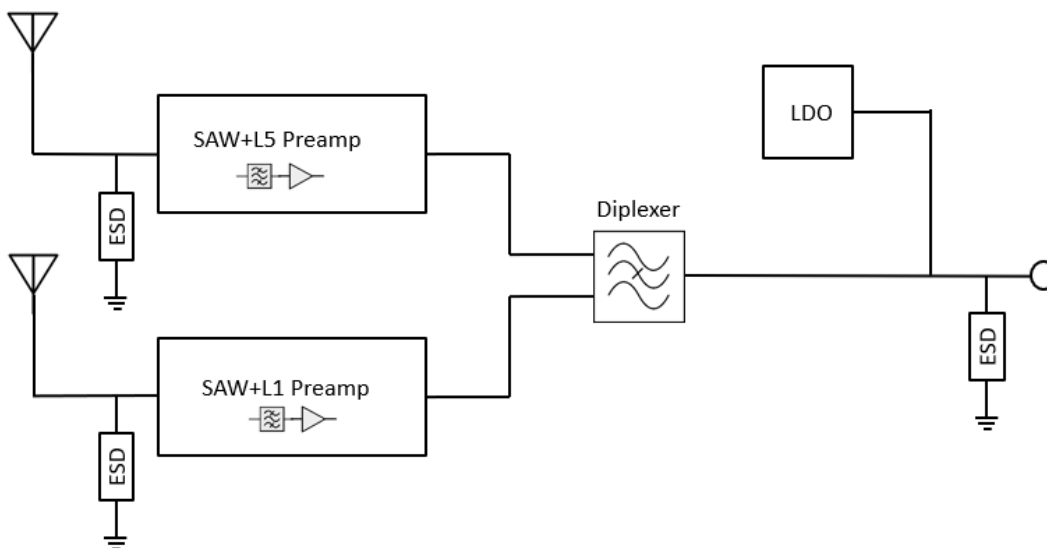

Return Loss

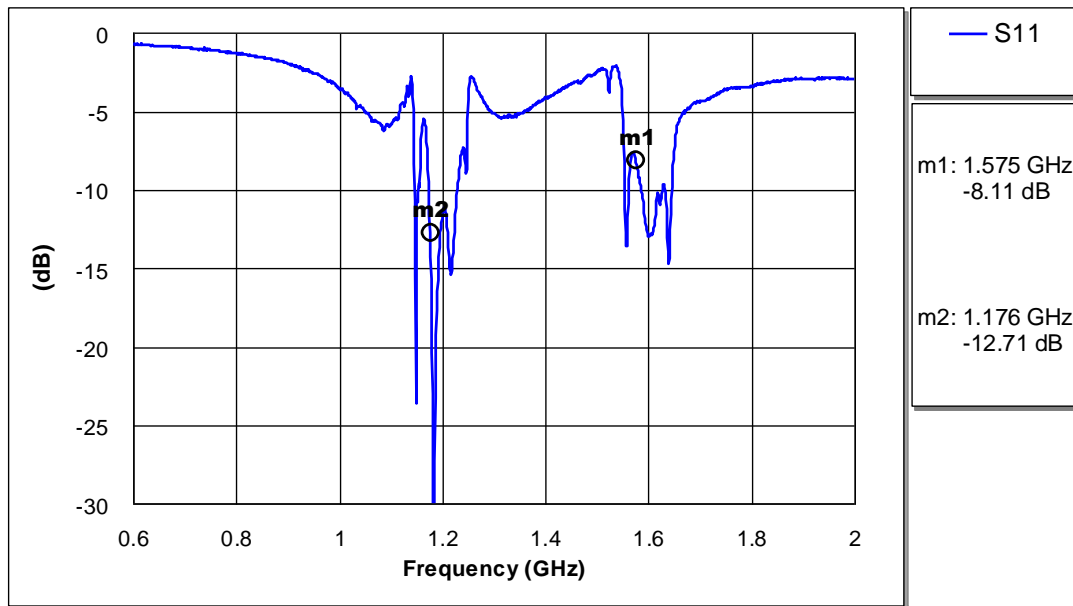

LNA Out of band rejection

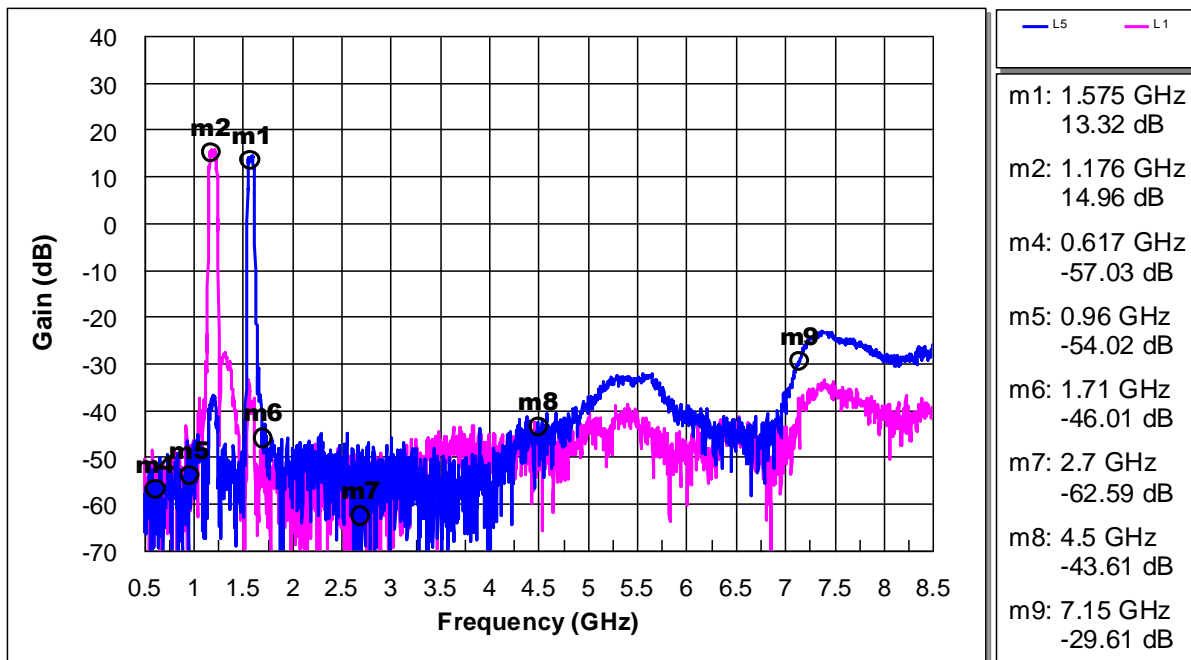

LNA Gain

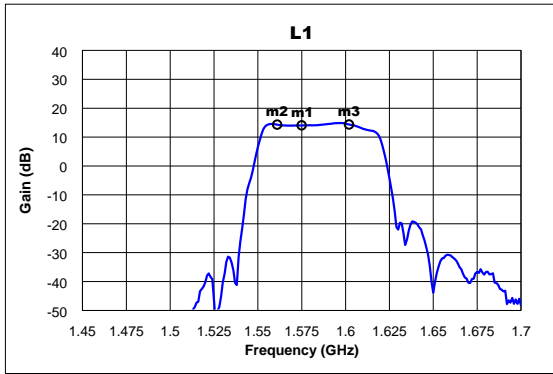

Marker	Frequency (GHz)	Gain (dB)
m1	1.575	14.03
m2	1.561	14.31
m3	1.602	14.35

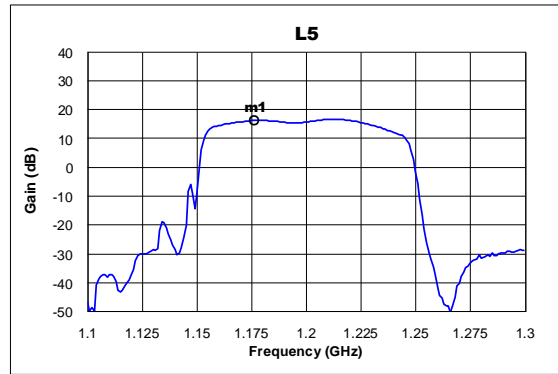

Marker	Frequency (GHz)	Gain (dB)
m1	1.176	16.11

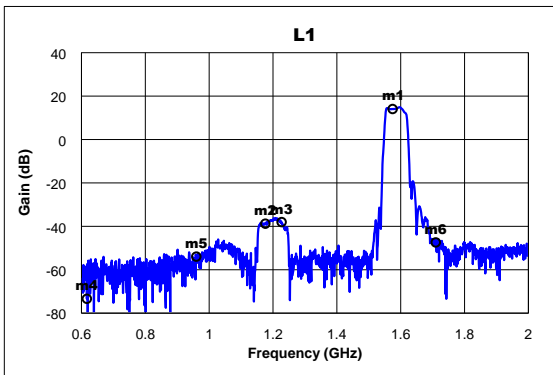

Marker	Frequency (GHz)	Gain (dB)
m1	1.575	14.03
m2	1.176	-38.82
m3	1.227	-38.10
m4	0.617	-73.41
m5	0.96	-53.95
m6	1.71	-47.42

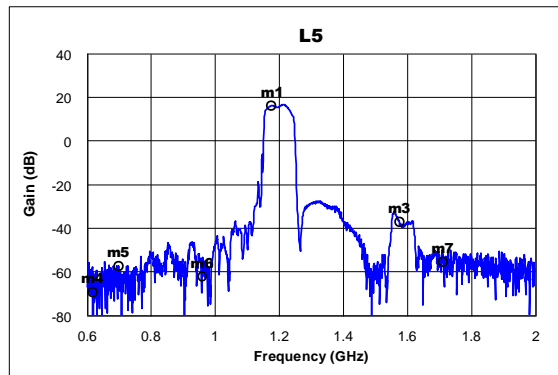

Marker	Frequency (GHz)	Gain (dB)
m1	1.176	16.11
m3	1.575	-37.36
m4	0.617	-69.41
m5	0.698	-57.62
m6	0.96	-62.39
m7	1.71	-55.46

LNA Noise Figure

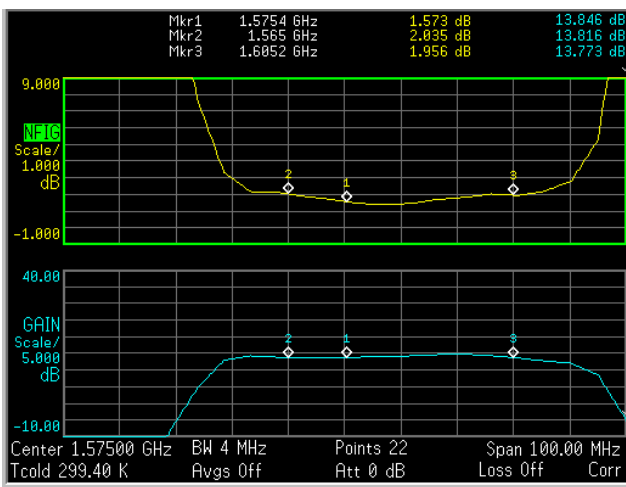

L1 Noise Figure

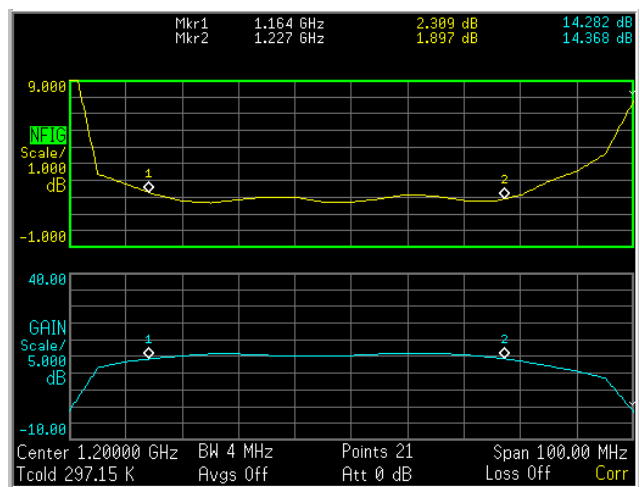

L5 Noise Figure

Radiating Element Efficiency

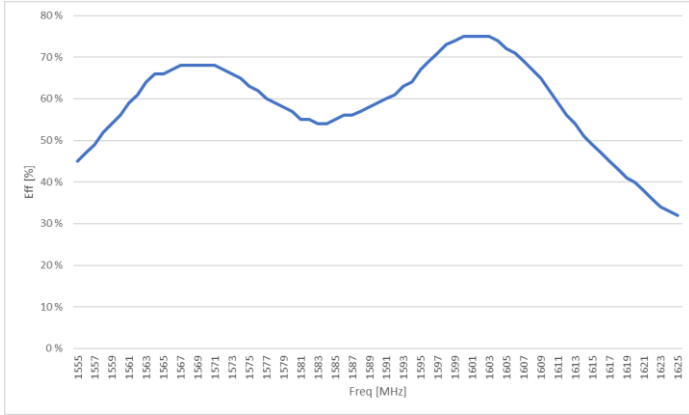

L1 Band

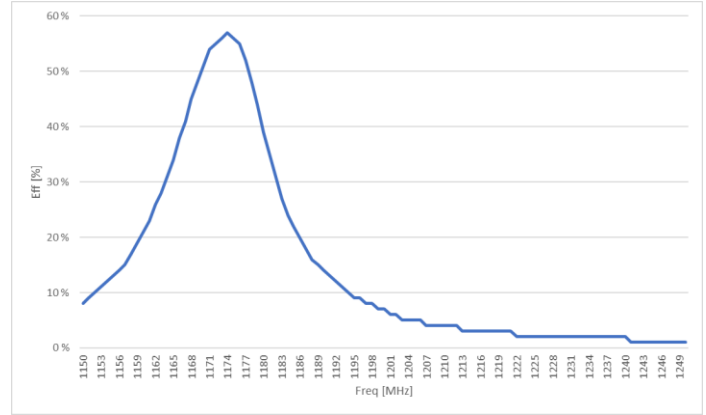

L5 Band

Radiating Element Peak Gain (Linear)

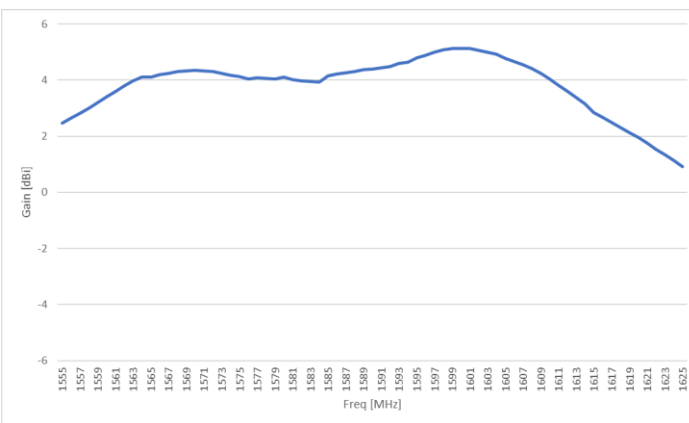

L1 Band

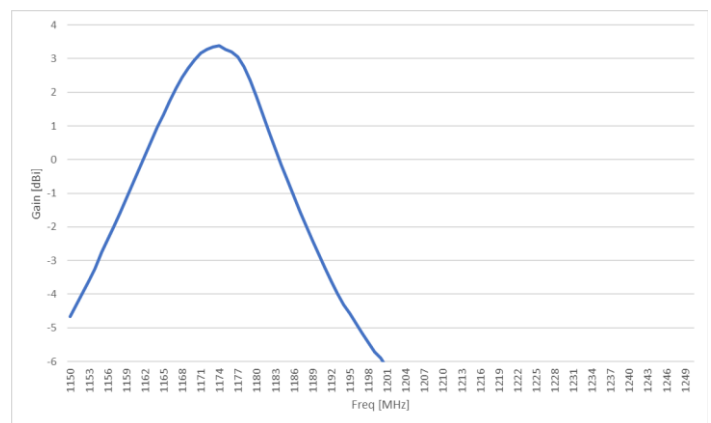

L5 Band

Radiation Patterns RHCP (dBic)

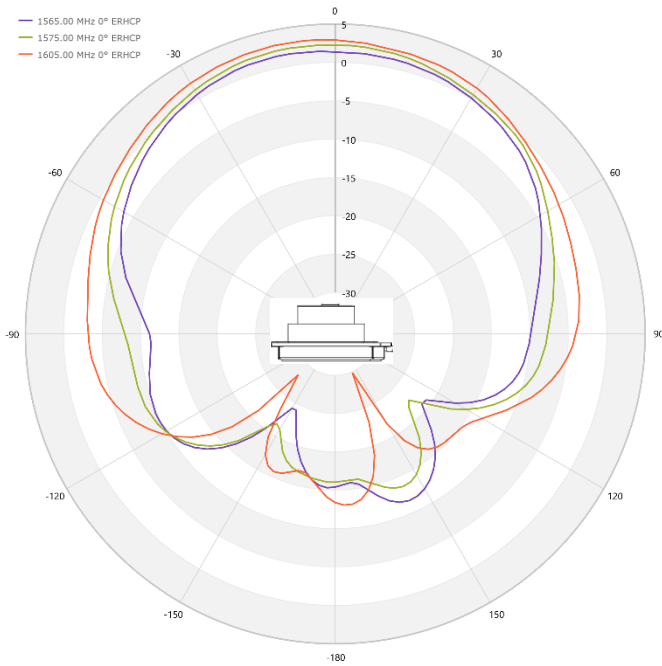

L1 RHCP Pattern

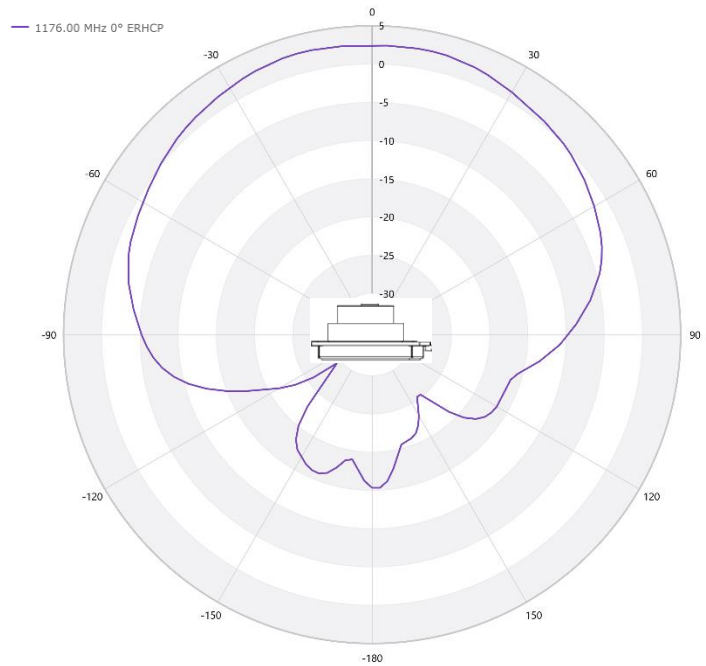

L5 RHCP Pattern

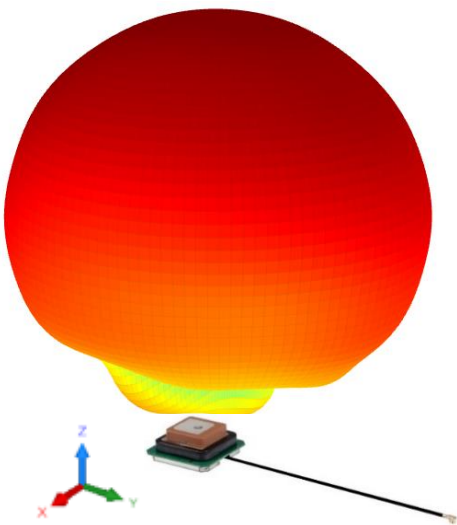

L1 3D RHCP Pattern
@1575 MHz

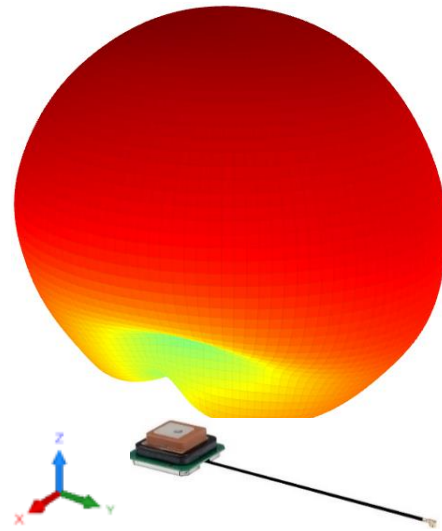

L5 3D RHCP Pattern
@1176 MHz

Reliability Tests

Temperature change	<p>-40°C to +85 °C, MIL-STD 810G Method 503.5.</p> <p>1.Room Temperature to -40 °C (2hours) 2.Storage for 2 hours at -40 °C 3. -40 °C to 85 °C (2hours) 4. Storage for 2 hours at 85 °C 5. 85 °C to -40 °C (2hours) 6.Repeat from 2 to 5 for 5 times 7. -40 °C increase to room temperature within 2 hours (Total 44 Hrs)</p> <p>No loss of function after tests.</p>
Storage test	<p>-40°C to +85°C, MIL STD 810G Method 501.5 (high) Method 502.5 (low)</p> <p>1.Room Temperature to -40°C within 2 hours 2.Storage for 24 hours at -40°C; 3. -40°C to room temperature within 2 hours 4.Room Temperature to +85°C within 2 hours 5.Storage for 24 hours at 85°C; 6. 85°C room temperature within 2 hours(Total 56 Hrs)</p> <p>No loss of function after tests.</p>
Shock test	<p>1.Three shocks in each direction shall be applied along the three mutually perpendicular axes of the test specimen (18 shocks) 2.Peak value: 1,500g's 3.Duration: 0.5ms 4.Waveform: Half si. No loss of function after tests.</p>
Drop test	<p>Drop test (single device) for mounted device, the antenna needs to be fixed to PCB and then assemble PCBA into the covers for the test, please do the test with Armadillo antenna, only need the PCB and top/bottom cover for the tests.</p>
Vibration test	<p>Random vibration input of 60 min/axis, all three perpendicular axis. Transportation frequency 5-500 Hz using Fig 514.6C-I and Table 514.6-II of MIL STD 810G section 514.6, performed only upon customer request., no loss of function after tests.</p>
ESD Test	<p>According to IEC/EN 61000-4-2 Electromagnetic compatibility Test voltage ±2KV, voltage polarity: + and - Discharge times: 3 times per polarity, discharge frequency: 1 time/second</p>

Package

Antennas packed in tray (ESD requirements according to DIN EN 61340-5.1) and carton box

Each antenna wrapped in foam bag

240 PCS/ carton box

Carton box dimensions (MM): 405x300x180

For More Information:

Americas - antennas.us@pulseelectronics.com | Europe – antennas.eu@pulseelectronics.com | Asia – antennas.as@pulseelectronics.com | Questions? +1-800-ANTENNA
 Performance warranty of products offered on this data sheet is limited to the parameters specified. Data is subject to change without notice. Other brand and product names mentioned herein may be trademarks or registered trademarks of their respective owners. © Copyright , 2020. Pulse Electronics, Inc. All rights reserved.
 Company address: Pulse Electronics, a YAGEO Company, 15255 Innovation Drive, Suite #100, San Diego, CA 92128

'YAGEO Corporation and its affiliates do not recommend the use of commercial, automotive, and/or COTS grade products for high reliability applications or manned space flight.'