

# SMT Common Mode Choke

PA4339.XXXNLT Series



- ⚙ **Height:** 3.8 mm MAX
- ⚙ **Footprint:** 7.5 mm x 6.5 mm MAX
- ⚙ **Rated Current:** up to 9.0 A
- ⚙ **Rated Voltage (MAX):** 80Vdc between windings.

## Electrical Specifications @ 25°C - Operating Temperature -40°C to 125°C

Part Number	Inductance (uH ± 50%)	Rated Current (A)	DCR/Winding (mOHms Max)	Impedance @ 100 MHz (ohms)		SRF (MHz)
				MIN	TYP	TYP
PA4339.101NLT	1.8	9.0	10	100	140	200
PA4339.301NLT	2.8	5.0	10	225	300	138
PA4339.501NLT	4.0	5.0	10	275	350	124
PA4339.701NLT	5.0	4.0	15	500	700	108
PA4339.102NLT	8.0	3.0	17	800	1020	93
PA4339.132NLT	9.0	2.5	21	910	1300	77

### Notes:

- The temperature of the component (ambient plus temperature rise) must be within the stated operating temperature range.
- The current rating (I<sub>rated</sub>) is based upon the temperature rise of the component and represents the rms current which will cause a typical temperature rise of 40°C.
- Inductance value is only for reference and is measured at 100kHz, 100Vrms.

## Mechanical

## Schematic

### PA4339.XXXNLT

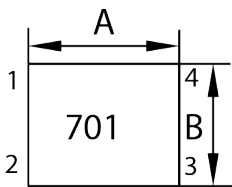

FINAL LAYOUT

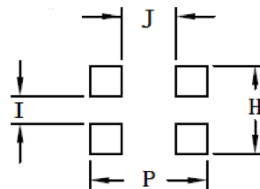
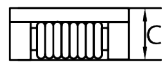
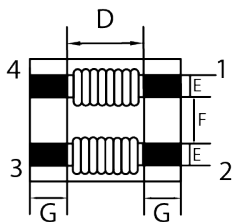

SUGGESTED PAD LAYOUT

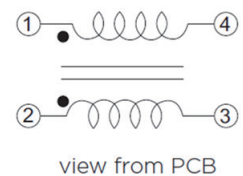

SERIES	A	B	C	D	E	F	G	I	H	J	P
PA4339.XXXNLT	7.0±0.5mm	6.0±0.5mm	MAX 3.8 mm	3.5mm	1.5±0.2mm	1.5±0.2mm	1.75±0.2mm	1.5mm	4.5mm	2.5mm	8.0mm

All Dimensions in mm.

# SMT Common Mode Choke

PA4339.XXXNLT Series



PA4339.XXXNLT, Typical Impedance versus Frequency

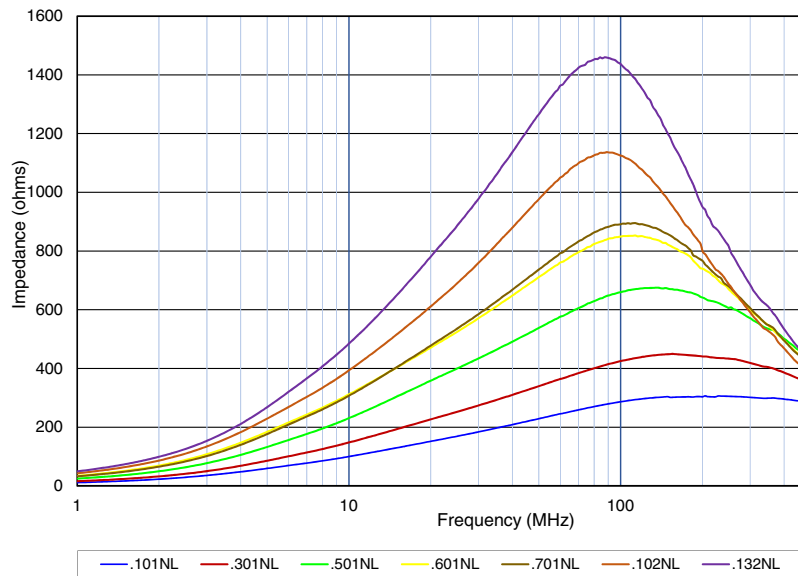

## TAPE & REEL INFO

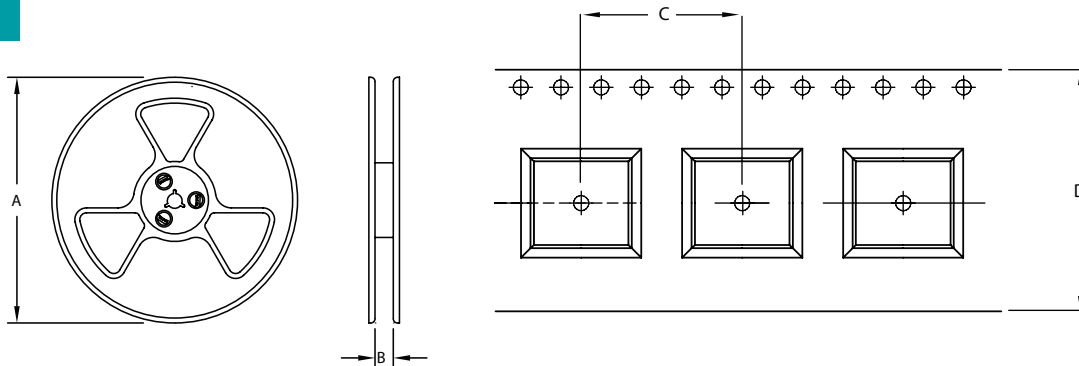

### SURFACE MOUNTING TYPE, REEL/TAPE LIST

SERIES	REEL SIZE (mm)		TAPE SIZE (mm)		QTY
	A	B	C	D	PCS/REEL
PA4339.XXXNLT	Ø330	16.4	12.0±0.1	16.0±0.3	1500

## For More Information

### Pulse Worldwide Headquarters

15255 Innovation Drive Ste 100  
San Diego, CA 92128  
U.S.A.

### Pulse Europe

Pulse Electronics GmbH  
Am Rottland 12  
58540 Meinerzhagen  
Germany

### Pulse China Headquarters

Pulse Electronics (Shenzhen) CO., LTD  
D708, Shenzhen Academy of  
Aerospace Technology,  
The 10th Keji South Road,  
Nanshan District, Shenzhen,  
P.R. China 518057

### Pulse North China

Room 2704/2705  
Super Ocean Finance Ctr.  
2067 Yan An Road West  
Shanghai 200336  
China

### Pulse South Asia

3 Fraser Street  
0428 DUO Tower  
Singapore 189352

### Pulse North Asia

1F., No.111 Xiyuan Rd  
Zhongli City  
Taoyuan City 32057  
Taiwan (R.O.C)

Tel: 858 674 8100  
Fax: 858 674 8262

Tel: 49 2354 777 100  
Fax: 49 2354 777 168

Tel: 86 755 33966678  
Fax: 86 755 33966700

Tel: 86 21 62787060  
Fax: 86 2162786973

Tel: 65 6287 8998  
Fax: 65 6280 0080

Tel: 886 3 4356768  
Fax: 886 3 4356820

Performance warranty of products offered on this data sheet is limited to the parameters specified. Data is subject to change without notice. Other brand and product names mentioned herein may be trademarks or registered trademarks of their respective owners. © Copyright, 2019. Pulse Electronics, Inc. All rights reserved.