







Sharkfin / Vehicular

5G-FR1+WiFi-6E+GNSS L1+L2 Direct Mount 6-in-1 Antenna

SKF5G62311DM - 617 to 7125 MHz



Features & Applications:

-  Vehicle roof mount, directly on metal plane
-  2x2 MiMo Cellular 5G-FR1 (4G compatible)
-  3x3 MiMo WiFi, DSRC, V2X (WiFi-6E compatible)
-  Active GNSS L1+L2 with low noise 38dB amplifier
-  Cable length and connector type per request
-  Heavy and light vehicles
-  IoT, navigation, tracking

ELECTRICAL SPECIFICATIONS @ 25°C ¹

General Specifications – 5G FR1 + WiFi 6E

Antenna type	Nominal Impedance	Polarization	Radiation pattern	Power withstanding	DC Ground
Monopole ²	50Ω	Vertical / Linear	Omni	45W	No

5G FR1 Antennas: 617 – 5925MHz

Port	Frequency (MHz)	617-960	1710-2700	3300-4200	4400-5000	5150-5925
Port 1, 2	VSWR	3:1	2:1	2.5:1	2.5:1	2.5:1
	Avg. Peak Gain (dBi)	2.3	4.6	4.9	5.7	5.4
	Avg. Efficiency (%)	51	54	68	68	62
Isolation ³	Port 1-2 (dB)	10	25	30	40	45

WiFi 6E Antennas: 2400-2500 / 4900-7125MHz

Port	Frequency (MHz)	2400-2500	4900-7125
Port 1,2,3	VSWR	2:1	2:5
	Avg. Peak Gain (dBi)	6.0	4.7
	Avg. Efficiency (%)	62	76
Port – Port Isolation ³	Port 1-2 (dB)	10	20
	Port 1-3 (dB)	12	25
	Port 2-3 (dB)	15	30

Notes:

1. Storage Temperature: -40°C to 85°C
2. (5) Multi-Band Monopoles with built in ground plane, Independent from external ground plane
3. Minimum Isolation (dB)



GNSS Antenna L1 Band: 1561.098 +/- 2.046MHz, 1575.42 +/- 1.023MHz, 1602.5625 +/- 4MHz				
GNSS Antenna L2 Band: 1227.6 +/- 1.023MHz				
Frequency (MHz)	L1 Band		L2 Band	
VSWR	2:1		2:1	
Gain – Radiating Element (dBic)	2 +/- 1		4 +/- 1	
Polarization	LNA Gain (dB)	Noise Figure (dB)	Operating Voltage (V _{dc})	Current Consumption (mA)
RHCP	38 +/- 2	< 2.4	3.3 – 5.0	< 11
Frequency (MHz)	960	1710	2170	2400
Out of Band Rejection (dB)	> 65	> 60	> 65	> 65

MECHANICAL SPECIFICATIONS

SKF5G62311DM					
Dimension (Length x Width x Height)	Housing Material	Color	Weight	Fixing System	Mounting Hole Diameter
178.3 x 52.5 x 62 mm (7.02 x 2.07 x 2.44 inch)	PC, UV Protected	Black	550g (1.22lbs)	Direct Mount	1.063" (27mm)
Wireless Technology	No. of Port	Cable Length	Cable Type	Connector Type	
5G FR1/ LTE	2	17ft (5.181m)	LMR195	SMA (Male)	
WiFi 6E	3	17ft (5.181m)	LMR195	RP-SMA Male	
GNSS L1	1	17ft (5.181m)	RG-174	SMA (Male)	

ENVIRONMENTAL SPECIFICATIONS

SKF5G62311DM			
Operating Temperature	Ingress Protection	RoHS Compliant	
-40 / +85° C	IP67	Yes	

Dimensions: inches (mm) Unless otherwise specified, all tolerances are ±.010 (0.25mm)

Mechanical Drawing

SKF5G62311DM

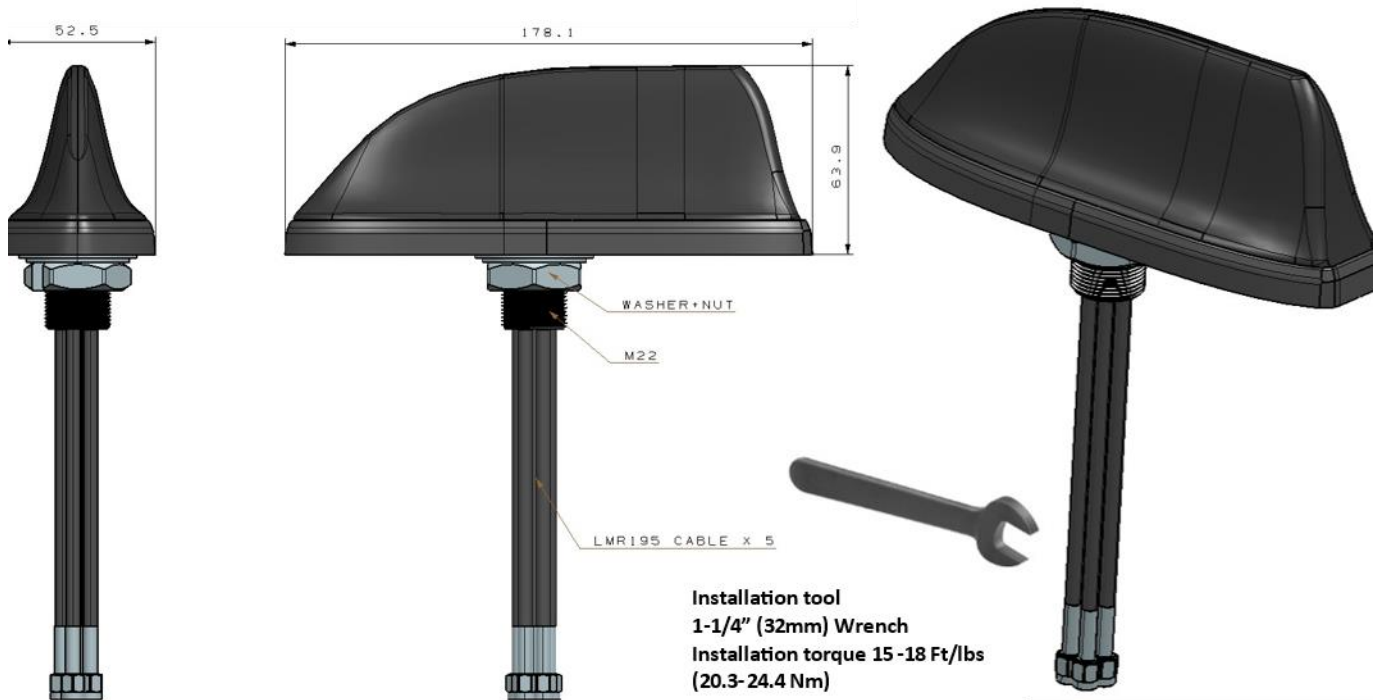

Test Setup

General / Chamber Setup

- All measurements done on \varnothing 500mm (20") round ground plane.
- S-parameters with 5m LMR 195 cable
- Gain and Efficiency with 0.5m LMR 195 cable
- Measured at Pulse, Suzhou





Charts-VSWR

5G FR1

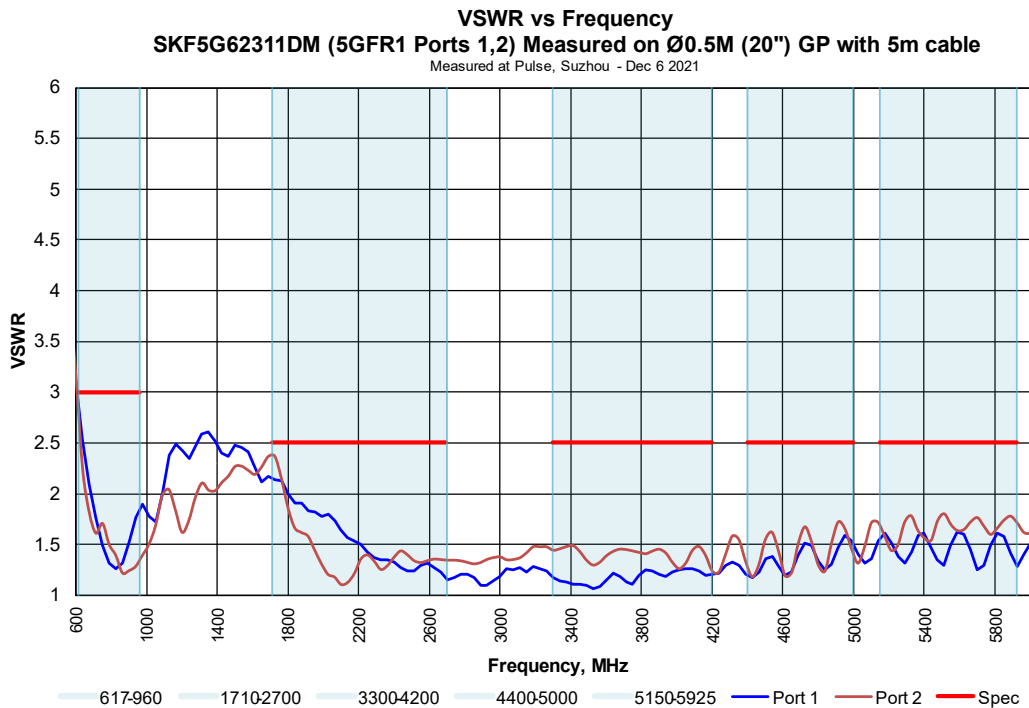

Charts-Isolation

5G FR1

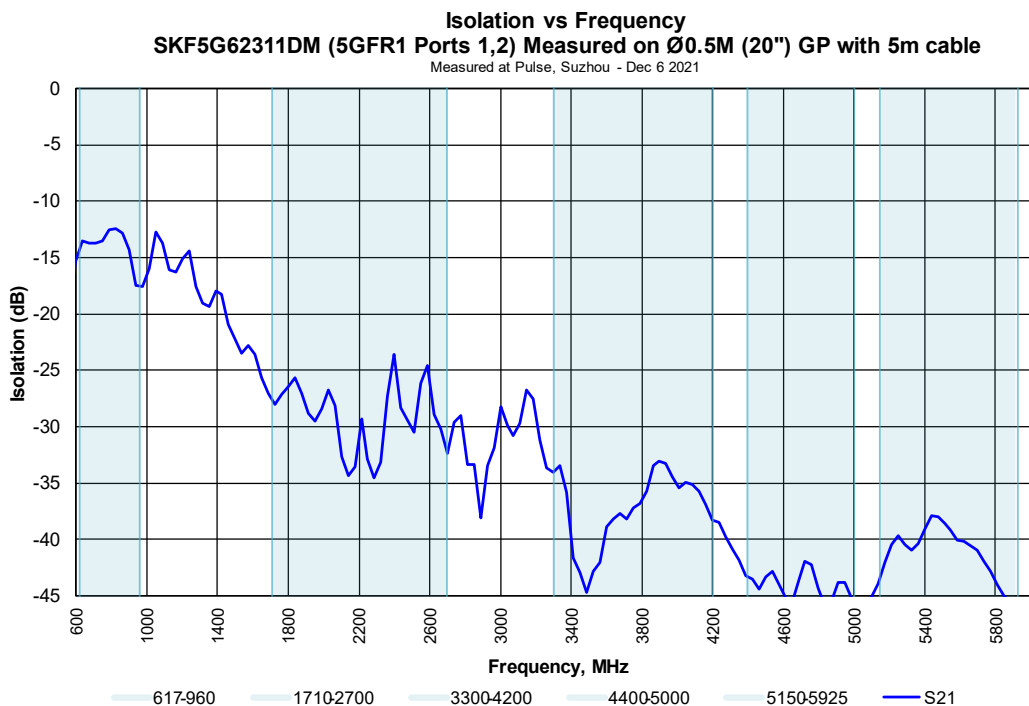



Charts-Peak Gain

5G FR1

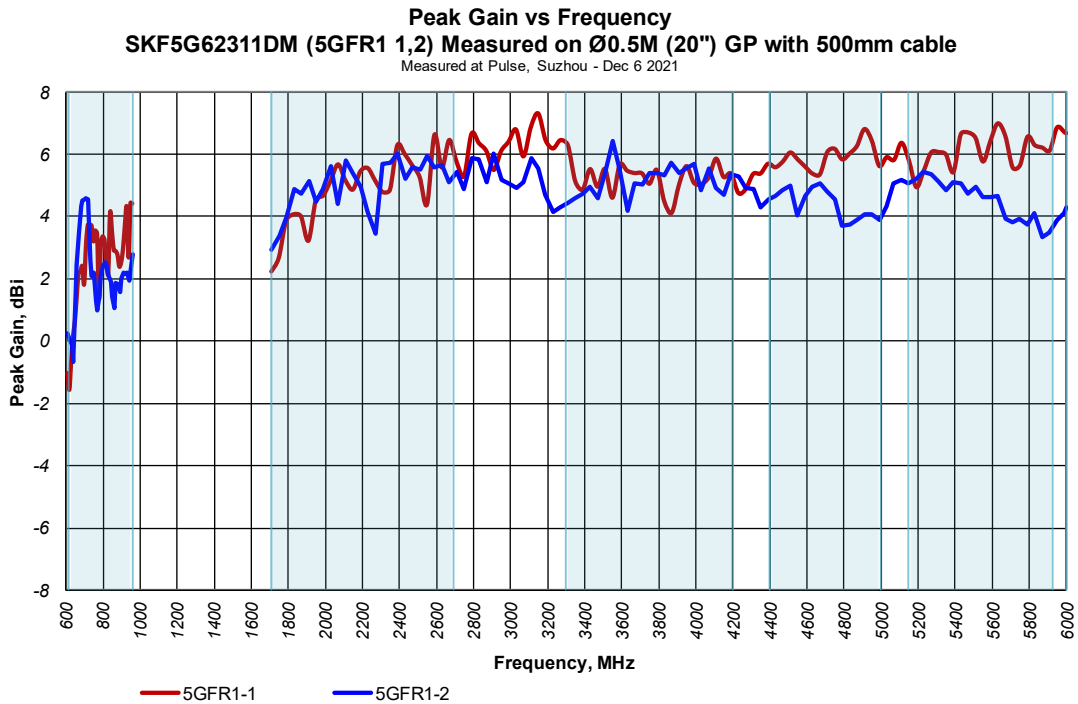

Charts- Peak Efficiency

5G FR1

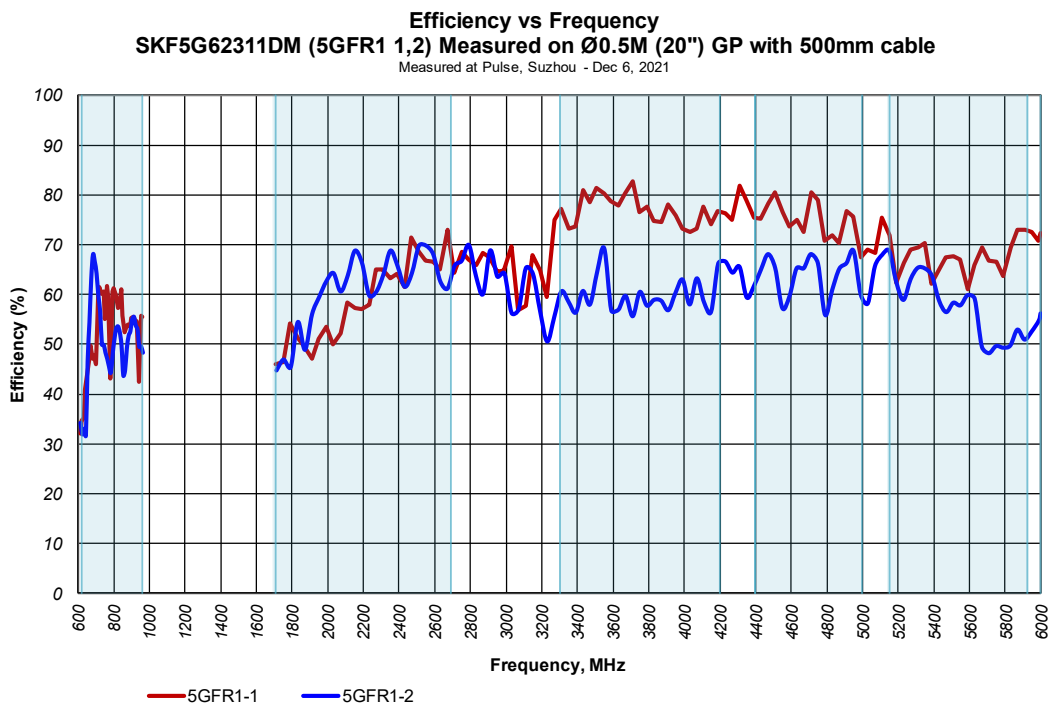

Radiation Pattern – 5G FR1 – Port 1 – XY & XZ Gain Plots

5G FR1 Port 1

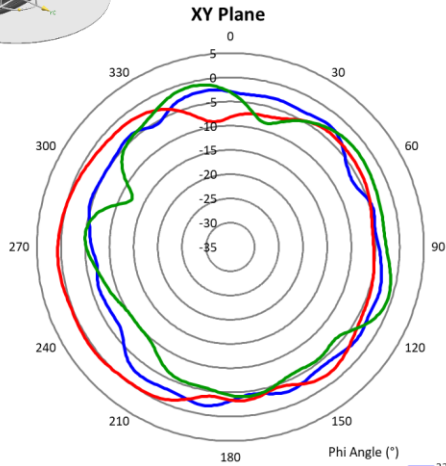
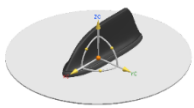

2230MHz
 Avg(dBi) = -3.89
 Peak(dBi) = -1.87
 Avg -3(deg) = 265.5
 3830MHz
 Avg (dBi) = -2.37
 Peak (dBi) = 0.75
 Avg -3 (deg) = 141.5
 800MHz
 Avg (dBi) = -4.38
 Peak (dBi) = -0.75
 Avg -3 (deg) = 121.5

— 2230MHz — 3830MHz — 800MHz

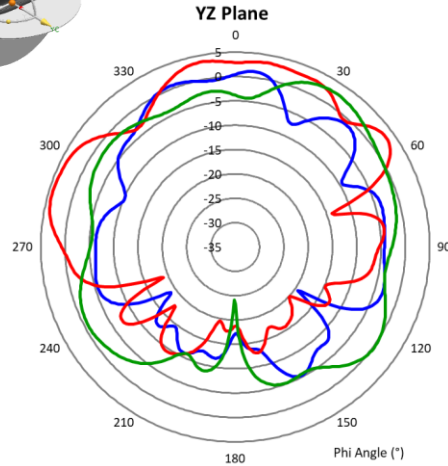
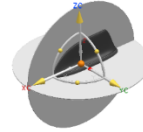

2230MHz
 Avg(dBi) = -4.56
 Peak(dBi) = 1.21
 Avg -3(deg) = 60.5
 3830MHz
 Avg (dBi) = -0.92
 Peak (dBi) = 4.20
 Avg -3 (deg) = 108.5
 800MHz
 Avg (dBi) = -2.10
 Peak (dBi) = 2.76
 Avg -3 (deg) = 57.5

— 2230MHz — 3830MHz — 800MHz

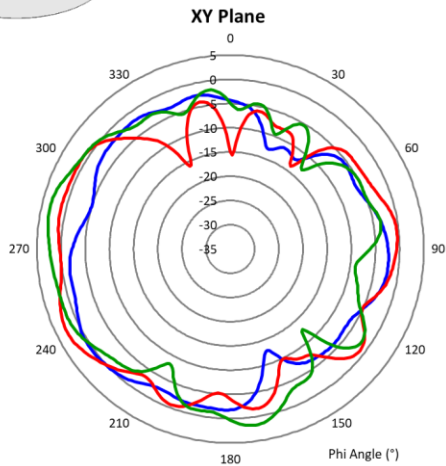
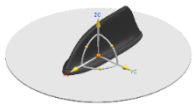

4710MHz
 Avg(dBi) = -3.38
 Peak(dBi) = 0.47
 Avg -3(deg) = 128.5
 5510MHz
 Avg (dBi) = -2.00
 Peak (dBi) = 2.84
 Avg -3 (deg) = 81.5
 6000MHz
 Avg (dBi) = -1.67
 Peak (dBi) = 3.30
 Avg -3 (deg) = 86.5

— 4710MHz — 5510MHz — 6000MHz

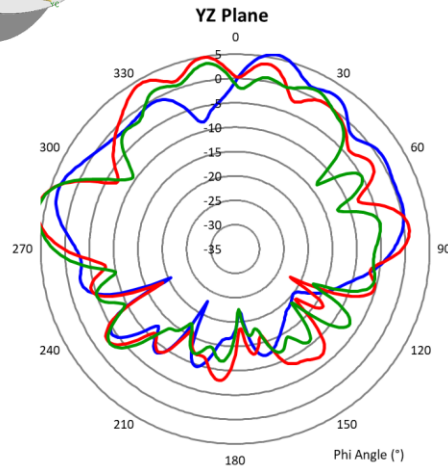
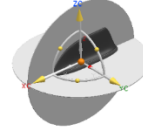

4710MHz
 Avg(dBi) = -1.62
 Peak(dBi) = 5.78
 Avg -3(deg) = 26.5
 5510MHz
 Avg (dBi) = -1.06
 Peak (dBi) = 6.47
 Avg -3 (deg) = 37.5
 6000MHz
 Avg (dBi) = -2.12
 Peak (dBi) = 6.32
 Avg -3 (deg) = 22.5

— 4710MHz — 5510MHz — 6000MHz



Radiation Pattern – 5G FR1 – Port 2 – XY & XZ Gain Plots

5G FR1 Port 2

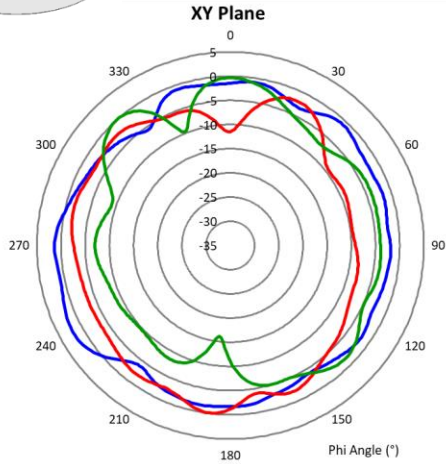
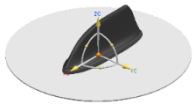

2230MHz
Avg(dBi) = -1.45
Peak(dBi) = 2.16
Avg -3(deg) = 58.5

3830MHz
Avg (dBi) = -3.97
Peak (dBi) = -0.12
Avg -3 (deg) = 144.5

800MHz
Avg (dBi) = -4.61
Peak (dBi) = 0.00
Avg -3 (deg) = 74.5

— 2230MHz — 3830MHz — 800MHz

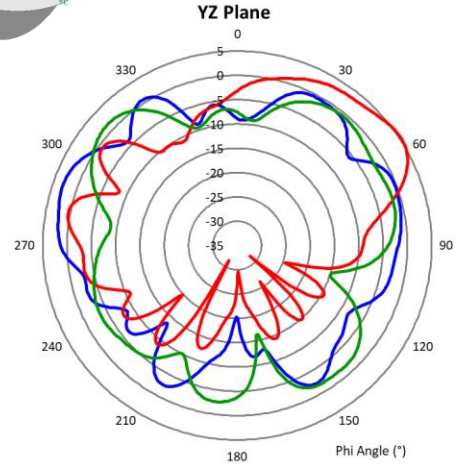
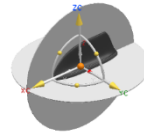

2230MHz
Avg(dBi) = -2.55
Peak(dBi) = 2.98
Avg -3(deg) = 46.5

3830MHz
Avg (dBi) = -2.58
Peak (dBi) = 5.30
Avg -3 (deg) = 42.5

800MHz
Avg (dBi) = -3.52
Peak (dBi) = 1.49
Avg -3 (deg) = 50.5

— 2230MHz — 3830MHz — 800MHz

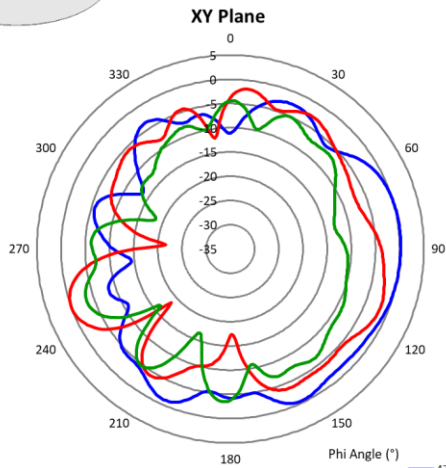
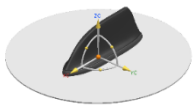

4710MHz
Avg(dBi) = -3.34
Peak(dBi) = 0.24
Avg -3(deg) = 135.5

5510MHz
Avg (dBi) = -4.96
Peak (dBi) = 0.00
Avg -3 (deg) = 62.5

6000MHz
Avg (dBi) = -7.87
Peak (dBi) = -3.44
Avg -3 (deg) = 76.5

— 4710MHz — 5510MHz — 6000MHz

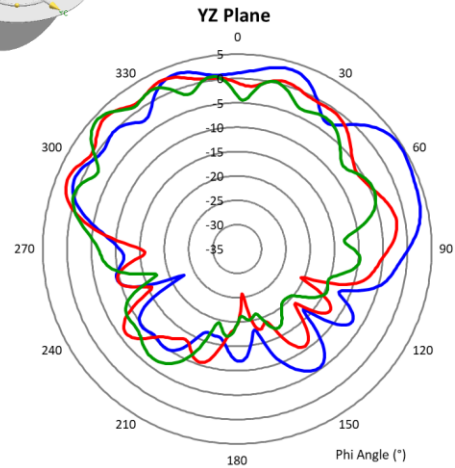
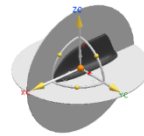

4710MHz
Avg(dBi) = -1.08
Peak(dBi) = 4.63
Avg -3(deg) = 74.5

5510MHz
Avg (dBi) = -2.65
Peak (dBi) = 3.28
Avg -3 (deg) = 77.5

6000MHz
Avg (dBi) = -3.72
Peak (dBi) = 4.18
Avg -3 (deg) = 28.5

— 4710MHz — 5510MHz — 6000MHz



Charts-VSWR

WiFi 6E

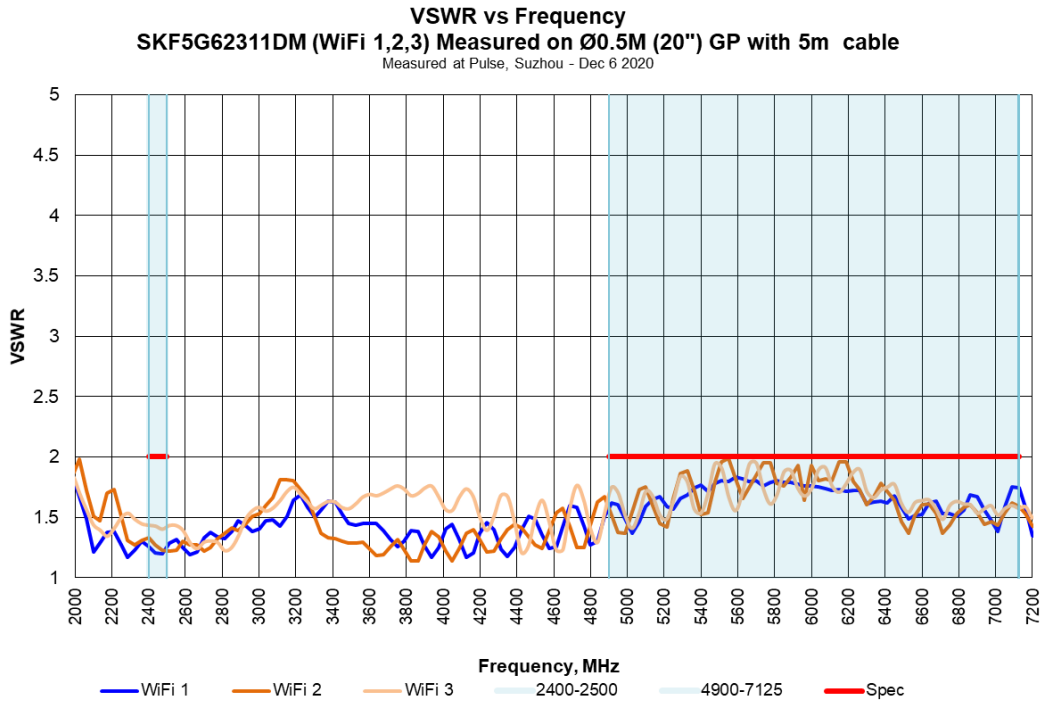

Charts-Isolation

WiFi 6E

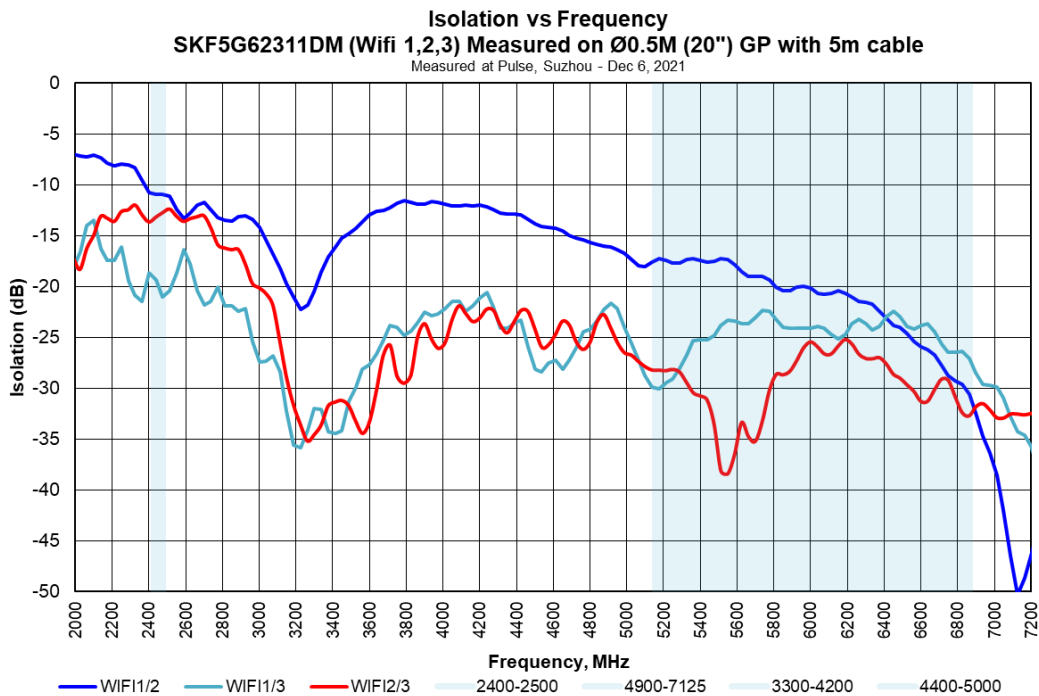



Charts-Peak Gain

WiFi 6E

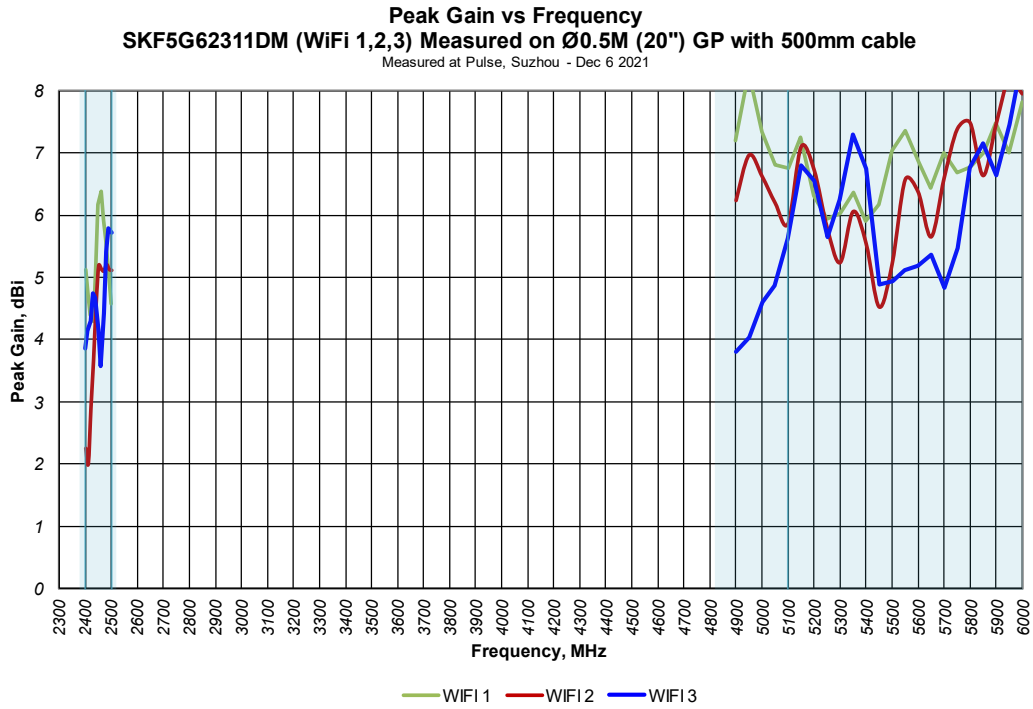

Charts- Peak Efficiency

WiFi 6E

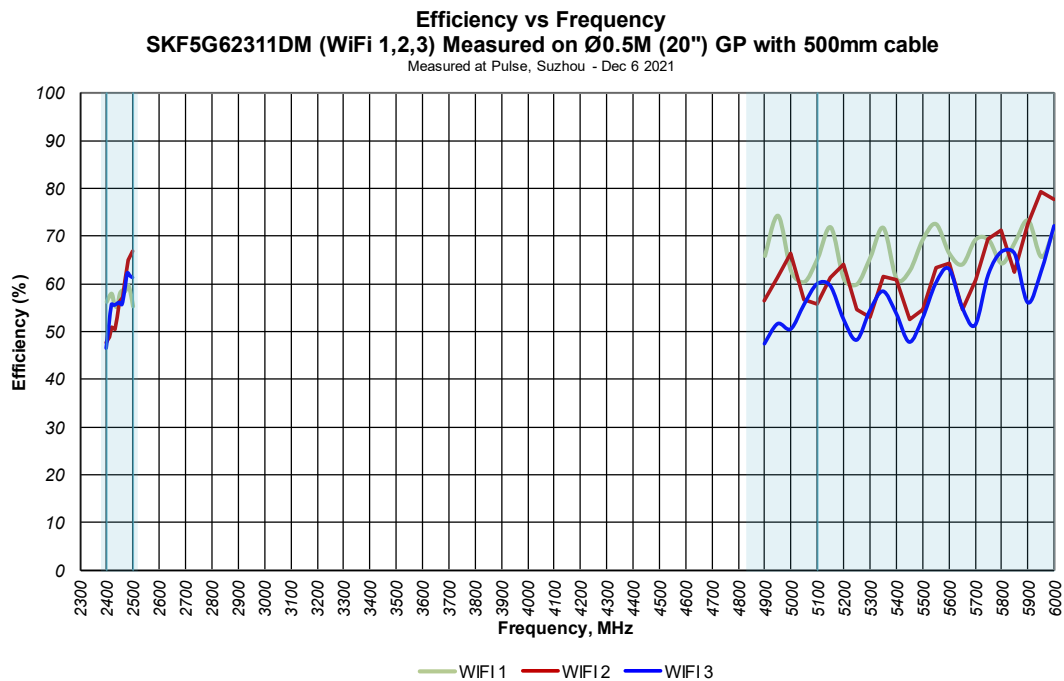



Radiation Pattern – WiFi 6E – Port 1 - XY & XZ Gain Plots

WiFi 6E Port 1

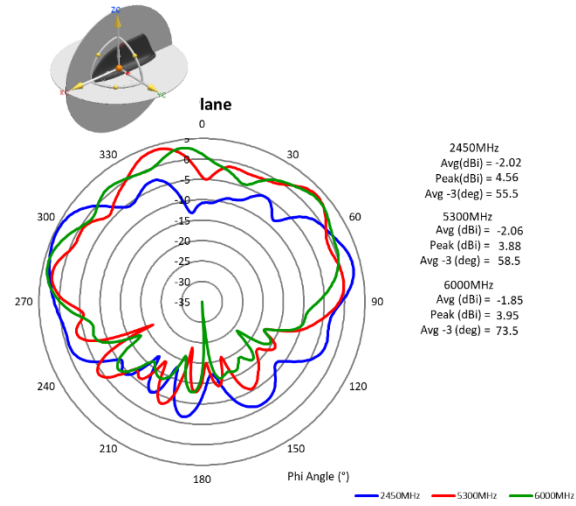
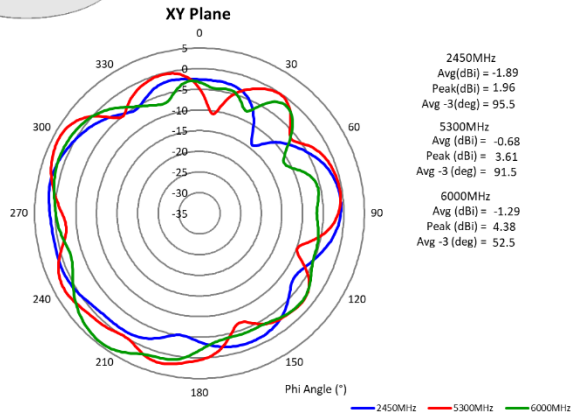
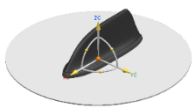

Radiation Pattern – WiFi 6E – Port 2 - XY & XZ Gain Plots

WiFi 6E Port 2

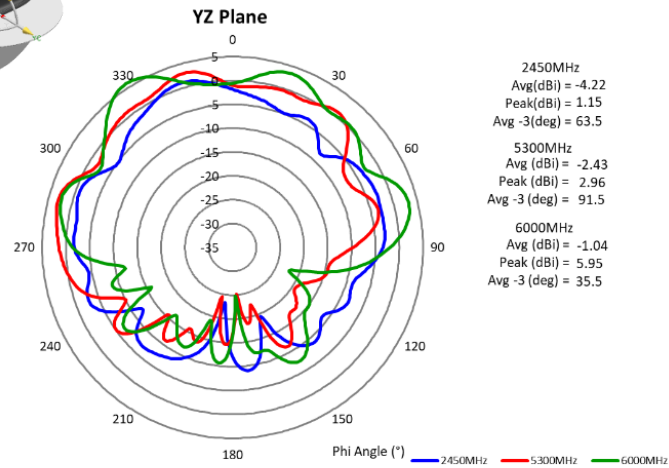
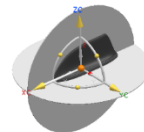
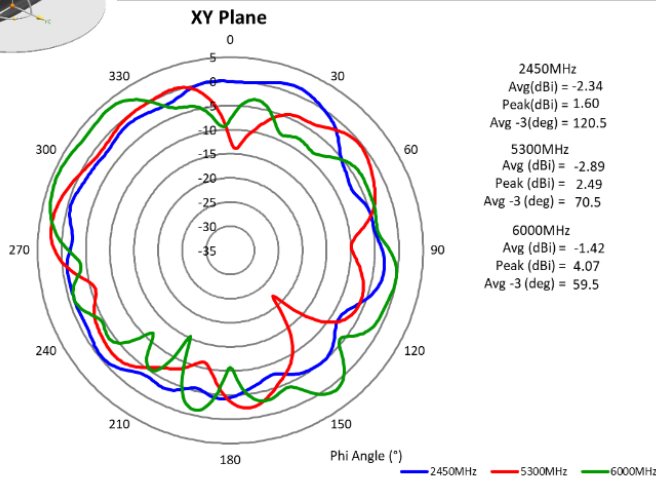
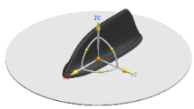



Radiation Pattern – WiFi 6E – Port 3 - XY & XZ Gain Plots

WiFi 6E Port 3

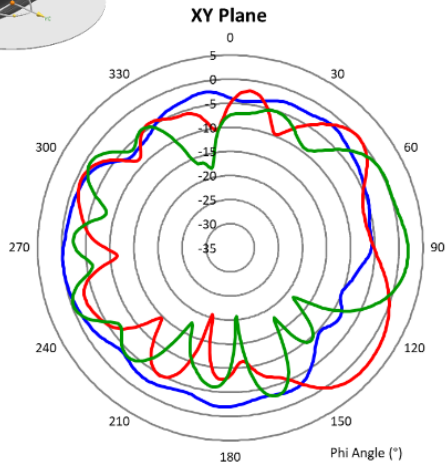
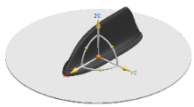

2450MHz
Avg(dBi) = -3.28
Peak(dBi) = -0.10
Avg -3(deg) = 167.5

5300MHz
Avg (dBi) = -3.32
Peak (dBi) = 2.41
Avg -3 (deg) = 50.5

6000MHz
Avg (dBi) = -3.90
Peak (dBi) = 1.91
Avg -3 (deg) = 61.5

— 2450MHz — 5300MHz — 6000MHz

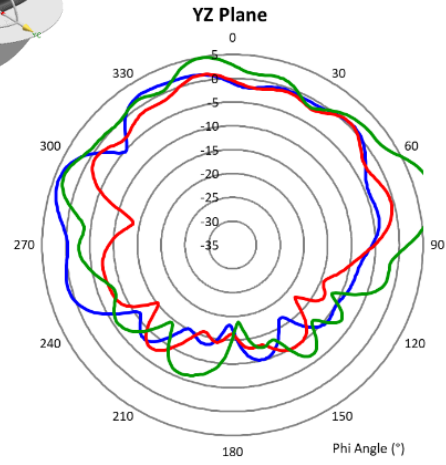
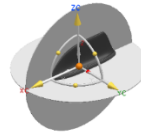

2450MHz
Avg(dBi) = -1.99
Peak(dBi) = 3.99
Avg -3(deg) = 54.5

5300MHz
Avg (dBi) = -4.08
Peak (dBi) = 1.33
Avg -3 (deg) = 104.5

6000MHz
Avg (dBi) = 0.45
Peak (dBi) = 8.46
Avg -3 (deg) = 20.5

— 2450MHz — 5300MHz — 6000MHz



GNSS Antenna - LNA Gain

LNA gain and Out-of-band Rejection (L1)

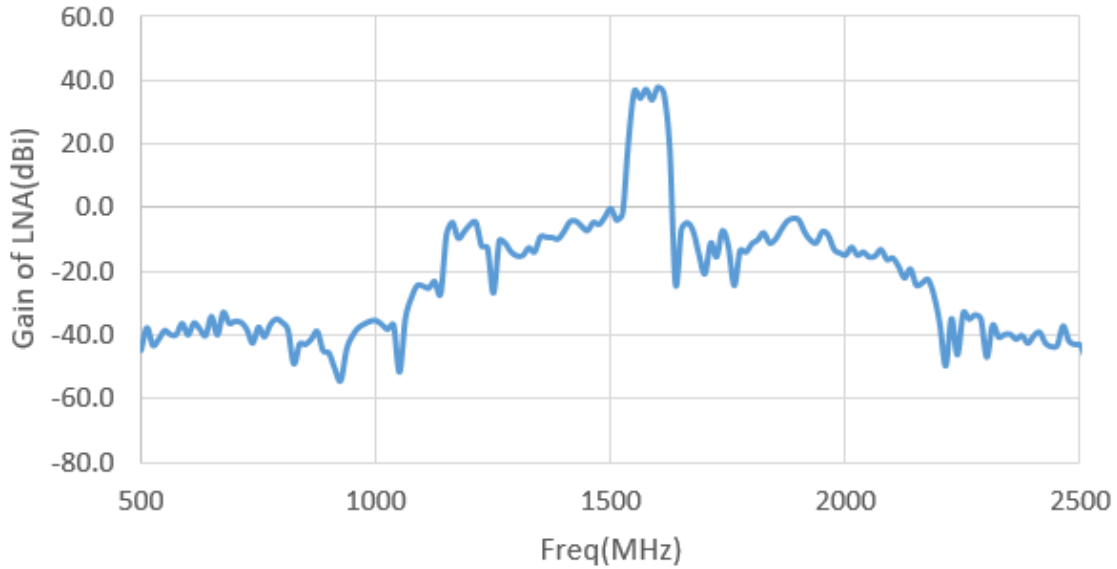

GNSS Antenna - LNA Gain

LNA gain and Out-of-band Rejection (L2)

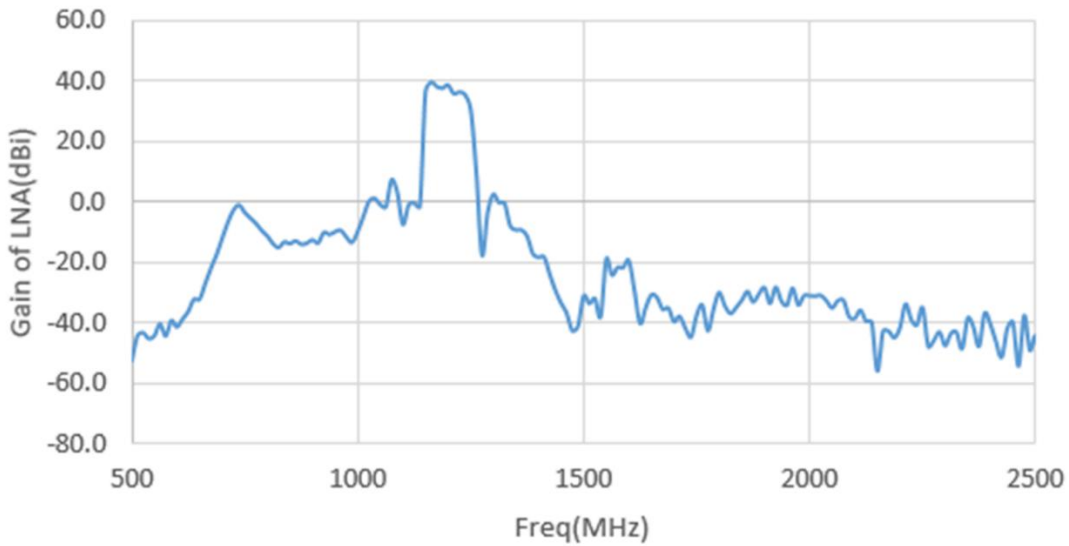



GNSS Antenna - Radiation Pattern (YZ Plane) Plots

YZ Plane: Passive measurement with 15" cable (L1)

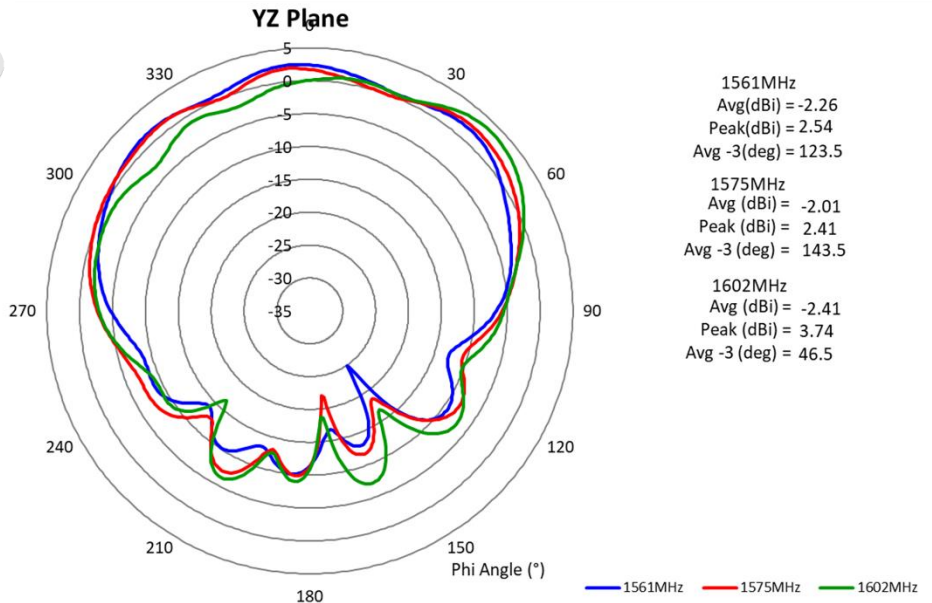
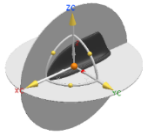

GNSS Antenna - LNA Gain and Radiation Pattern (YZ Plane) Plots

YZ Plane: Passive measurement with 15" cable (L2)

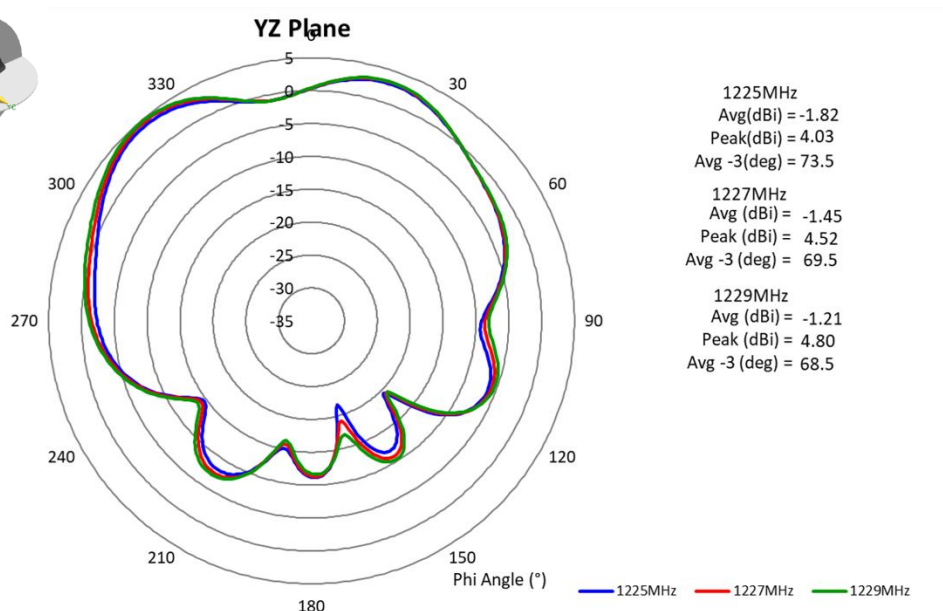
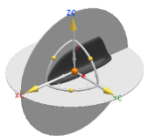



PACKAGING

SKF5G62311DM

1pcs antennas per plastic bag

2pcs antennas per package box

Package box: 17x x12 x 9in

Notes:

1. Please contact sales for availability, lead time, and/or any special requests. Samples available upon request.

For More Information:

[Americas - antennas.us@pulseelectronics.com](mailto:antennas.us@pulseelectronics.com) | [Europe – antennas.eu@pulseelectronics.com](mailto:antennas.eu@pulseelectronics.com) | [Asia – antennas.as@pulseelectronics.com](mailto:antennas.as@pulseelectronics.com) | [Questions?](#) +1-800-ANTENNA
Performance warranty of products offered on this data sheet is limited to the parameters specified. Data is subject to change without notice. Other brand and product names mentioned herein may be trademarks or registered trademarks of their respective owners. © Copyright , 2020. Pulse Electronics, Inc. All rights reserved.