

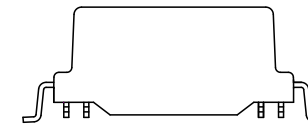

NOTES:

1. ROHS COMPLIANT
2. HEADER: DAP (DIALLYL PHTHALATE) WITH FLAMMABILITY RATING UL 94V-0 OR BETTER.
3. STORAGE TEMPERATURE: -55°C TO +125°C
4. COMPLIANCE TO J-STD:
  - A. J-STD-002: SOLDERABILITY AT 245°C REFLOW PROFILE
  - B. J-STD-020: LEVEL 1, NO MOISTURE SENSITIVE
  - C. J-STD-075: R7, 245°C MAXIMUM THROUGH REFLOW SOLDER
5. TO ORDER TAPE & REEL PACKAGING ADD A "T" SUFFIX TO THE PART NUMBER(i.e HX7028NL BECOMES HX7028NLT).

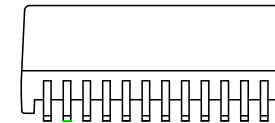
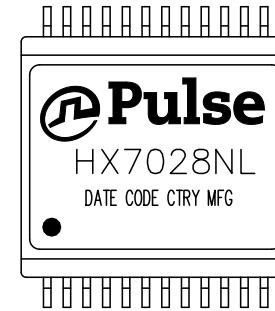

FINAL OUTLINE

© Copyright, 2020. Pulse Electronics Corp. All rights reserved. Pulse confidential & proprietary. (10/30/20)

PRODUCT DESCRIPTION	TLA DRAWING	PS DRAWING	SHEET	PART NO.	DATASHEET REV.
MDL,SIN,10G,1:1,GEN2,SM,TU	HX7028NL-10	PS-2517.001-B	1 OF 3	HX7028NL	B

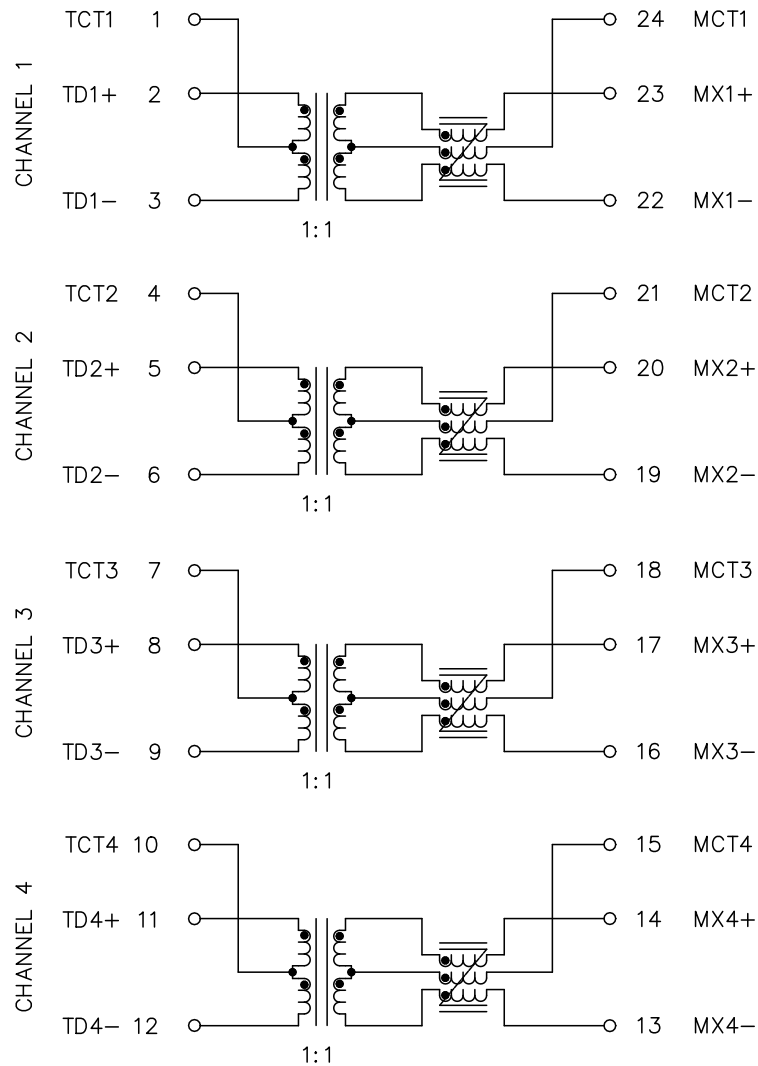

SCHEMATIC

ELECTRICAL CHARACTERISTICS AT +25°C UNLESS OTHER SPECIFIED  
MEETS IEEE 802.3 SPECIFICATION

PARAMETER	SPECIFICATIONS		
OPERATING TEMP	-40°C TO +85°C		
TURNS RATIO	1.00 ± 2%		
POLARITY	PER SCHEMATIC		
INSERTION LOSS	100 KHz	1-500 MHz	
	-3.0 dB MAX	-1.0 dB MAX (-.6 dB TYP)	
RETURN LOSS (Z OUT = 100 OHM ± 1%)	2-100 MHz	100 MHz-500 MHz	
	-25 dB MIN	-11 + 17*LOG <sub>10</sub> (f/400)	
INDUCTANCE (OCL)	120 uH TYP @ 100 kHz, 100 mV		
CROSSTALK, ADJACENT CHANNELS	1-100 MHz	100-500 MHz	
	-40 dB MIN	-30 dB MIN	
COMMON MODE REJECTION RATIO	1-100 MHz	100-300 MHz	300-500 MHz
	-35 dB MIN	-30 dB MIN	-25 dB MIN
COMMON TO DIFFERENTIAL MODE REJECTION (CDMR)	1-250 MHz		250-500 MHz
	-30 dB MIN		-22 dB MIN
INPUT - OUTPUT ISOLATION	1500 VRMS MIN @ 60 SECONDS		

NOTE: f IS FREQUENCY IN MHz.

© Copyright, 2020. Pulse Electronics Corp. All rights reserved. Pulse confidential & proprietary. (10/30/20)

PRODUCT DESCRIPTION	TLA DRAWING	PS DRAWING	SHEET	PART NO.	DATASHEET REV.
MDL,SIN,10G,1:1,GEN2,SM,TU	HX7028NL-10	PS-2517.001-B	2 OF 3	HX7028NL	B

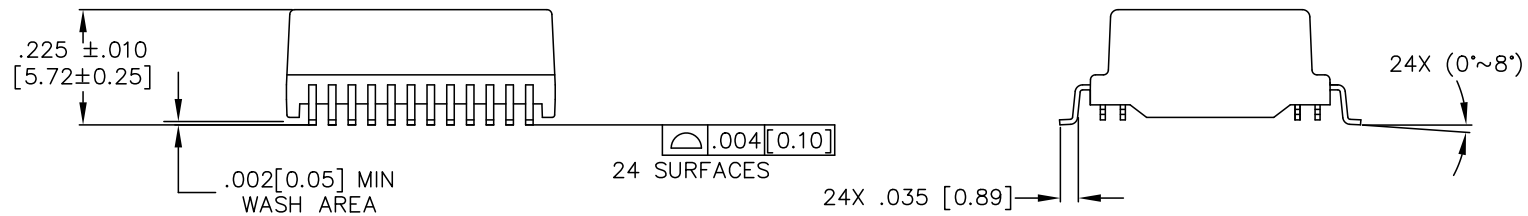
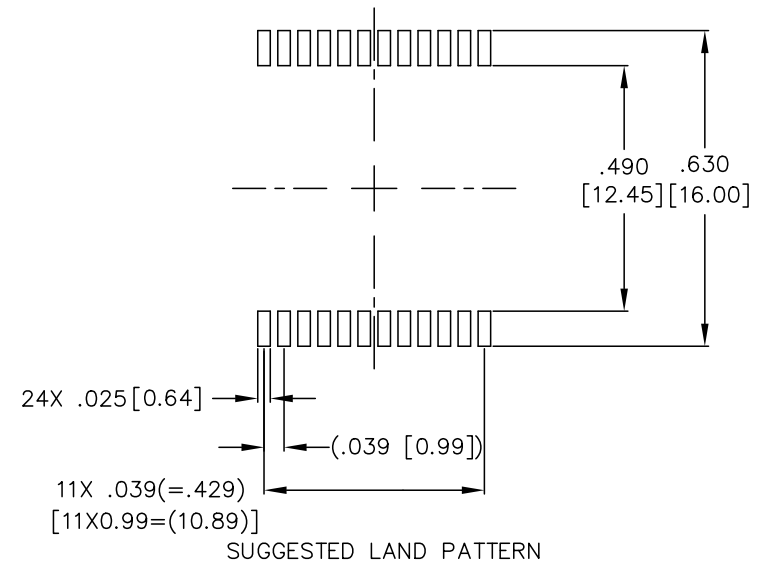
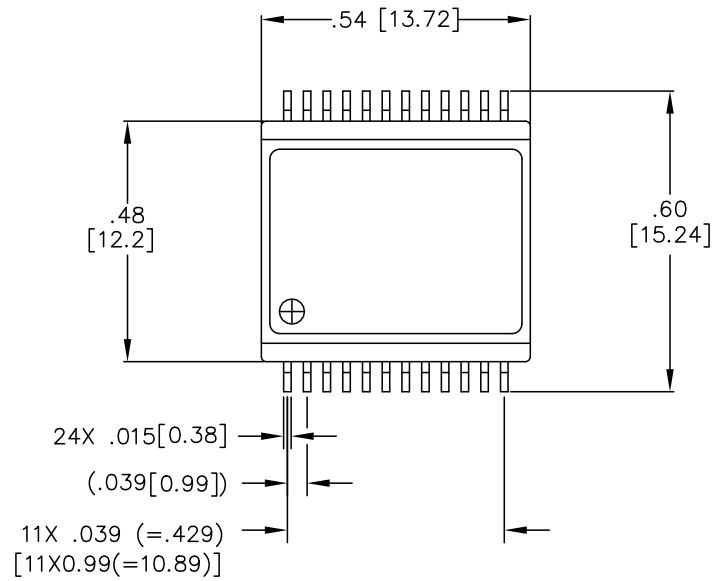

DIMENSIONS ARE IN INCHES [MILLIMETERS] WITH THE FOLLOWING TOLERANCES: [MILLIMETERS] ARE FOR REFERENCE ONLY.  
 .XX= ±.01 [±0.25]  
 .XXX= ±.005 [±0.13]

© Copyright, 2020. Pulse Electronics Corp. All rights reserved. Pulse confidential & proprietary. (10/30/20)

PRODUCT DESCRIPTION	TLA DRAWING	PS DRAWING	SHEET	PART NO.	DATASHEET REV.
MDL,SIN,10G,1:1,GEN2,SM,TU	HX7028NL-10	PS-2517.001-B	3 OF 3	HX7028NL	B